



INSTALLATION MANUAL
PRERUNNER WINCH MOUNT
PRODUCT NUMBER: N5960
APPLICATION: 2023 FORD SUPER DUTY



IMPORTANT SAFETY GUIDE | Your safety and the safety of others is very important.

In order to help you make informed decisions about safety, we have provided the following warnings, safety precautions, installation instructions, and other important information to alert you to potential hazards that could hurt you or others.

Please do a job safety analysis before each task to identify potential hazards for your situation and remove/protect against them. Use own good judgment and take your time.

Check packaged materials immediately upon arrival to ensure that all listed parts are included and undamaged.

Read and understand all warnings, safety precautions, and instructions before installing this product.

SENSORS FIELD OF VIEW MAY BE ALTERED WITH USE OF THE REPLACEMENT BUMPER.

WARNINGS

- Failure to observe the following warnings and instructions provided in this manual could lead to severe injury and/or death.
- For professional installation only. Careless installation and/or operation can result in serious injury, death, and/or equipment damage. All liability for installation and use rests with the user or consumer.
- Fab Fours, Inc. only approves installing this product according to these written instructions with the hardware provided. Failure to install according to these instructions will invalidate the warranty. This includes, but is not limited to, using alternative installation methods, hardware, or materials.
- This product is for off road use only.

SAFETY PRECAUTIONS

- Always remove jewelry and wear eye protection.
- Always use extreme caution when jacking up a vehicle for work. Set emergency brake and use tire blocks. Locate and use the vehicle manufacturers designated lifting points. Use jack stands.
- Always use appropriate and adequate care in lifting components into place.
- Always ensure components will remain secure during installation and operation.
- Always wear safety glasses when installing this kit. A drilling operation will cause flying metal chips. Flying chips can cause serious eye injury.
- Always use extreme caution when drilling a vehicle. Always disconnect power before welding. Thoroughly inspect the area to be drilled (on both sides of material when possible) prior to drilling, and relocate any objects that may be damaged.
- Always use extreme caution when welding a vehicle. Thoroughly inspect the area to be welded (on both sides of material when possible) prior to welding, and relocate any objects that may be a fire hazard. When welding in a cab, make sure the interior surfaces are covered (e.g., welding blanket) and a fire extinguisher is at hand.
- Always use extreme caution when cutting and trimming during fitting.
- Always tighten all nuts and bolts securely per installation instructions.
- Always route electrical cables carefully. Avoid moving parts, components that become hot, and rough or sharp edges.
- Always insulate and protect all exposed wiring and electrical terminals.
- Perform regular inspections and maintenance on mounts and hardware.

TABLE OF CONTENTS

- 2 SAFETY / DISCLAIMER
- 3 TABLE OF CONTENTS
- 4 A MESSAGE FROM THE OWNER
- 5 GETTING STARTED
- 6 PROVIDED MATERIAL
- 8 INSTALLATION
- 15 CONTACT

A MESSAGE FROM THE FOUNDER



Fab Fours' was born out of a passion for customizing vehicles and a love of the outdoors. Our engineering team uses the latest 3D design software to turn new product ideas into reality. In our factory, designs come to life with the combination of cutting edge technology for metal cutting and forming and an American workforce that puts its' heart and pride into every product.

From design and manufacturing, to quality and delivery, Fab Fours' mission is to be the market leader for steel truck and jeep accessories. We make sure a quality product is delivered on time, more than expected, better than expected to our customers.

Enjoy your new Fab Fours product. Welcome to the family!

Greg Higgs

FOUNDER, FAB FOURS

GETTING STARTED

Before you begin the installation process of your new Fab Fours product, we suggest laying out all materials and parts on a pad or protective surface.

Failure to fully account for all components before beginning installation may leave vehicle immobile until part is acquired. Refer to the next pages as an inventory check.

PROVIDED MATERIALS

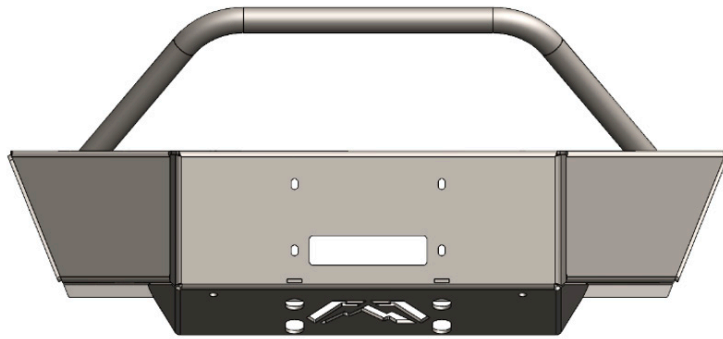

23047 - PRERUNNER WINCH MOUNT

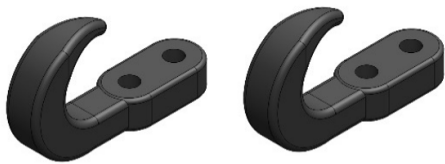

61366 - TOW HOOKS QTY: 2

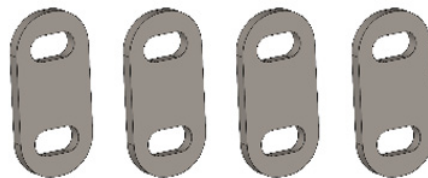

23036 - 1/4" SPACERS QTY: 4

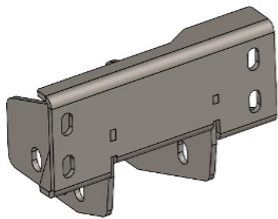

23034 - DS FRAME BRACKET

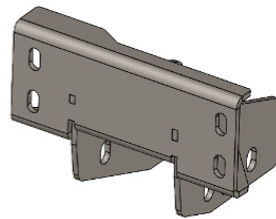

23035 - PS FRAME BRACKET

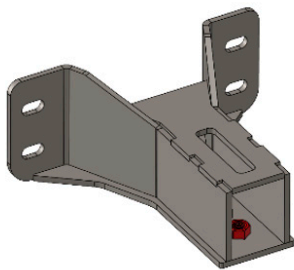

23044 - DS INTERMEDIATE BRACKET

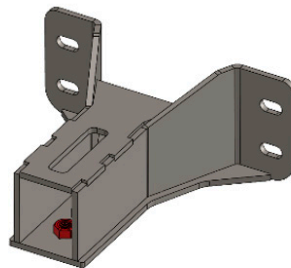

23045 - PS INTERMEDIATE BRACKET

TOOLS REQUIRED

- 18MM SOCKET WRENCH
- 3/4" SOCKET WRENCH & OPEN-END WRENCH
- 8MM SOCKET WRENCH (IF ACC EQUIPPED)

ASSISTANCE

We recommend two people perform the installation as items are heavy and may need to be held in place while installing.

ORGANIZATION

Disassemble the vehicle where you can catalog and store everything. We suggest labeling and bagging all the OEM bolts when removing from the vehicle. Failure to keep track of parts could lead to an inability to properly reinstall components.

HARDWARE KIT | 50413-HW

IDENTIFICATION NUMBER	COMPONENT DESCRIPTION	QTY
50413-HW	1/2" X 1.75" YELLOW ZINC HEX HEAD BOLT, GRADE 8	12
50413-HW	1/2" X 2.25" YELLOW ZINC HEX HEAD BOLT, GRADE 8	12
50413-HW	1/2" YELLOW ZINC FLAT WASHER, GRADE 8	40
50413-HW	1/2" YELLOW ZINC LOCK WASHER, GRADE 8	24
50413-HW	1/2" YELLOW ZINC HEX NUT, GRADE 8	16

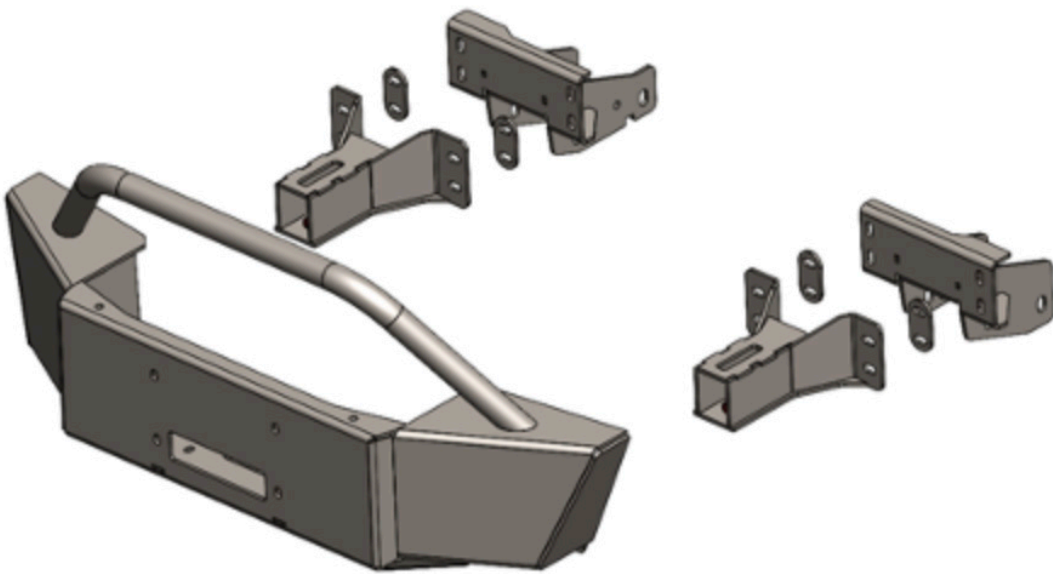

Exploded View

INSTALLATION

1. Remove plastic tow hook shrouds from front bumper. (Figure 1)



Figure 1

2. Unplug sensors and adaptive cruise control (ACC) from truck wiring harness. (Figure 2)



Figure 2

3. Using 18mm socket, unbolt OEM bolts from bumper (four per side) and remove bumper from truck. (Figure 3)



Figure 3

4. Remove OEM tow hooks by removing four (4) bottom bolts using 18mm socket, (Figure 4)



-
5. Using 18mm wrench, remove four (4) nuts to remove frame horn from frame. Repeat for opposite. (Figure 5)

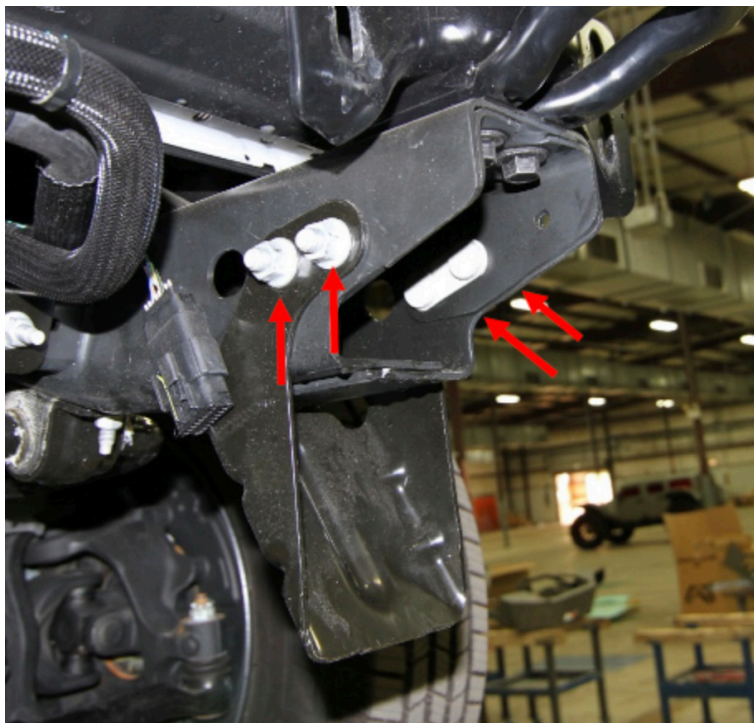

Figure 5

6. Install 23034 mounting bracket to driver's side frame rail by aligning rear two (2) holes in top of frame with weld nuts in top of bracket. (Figure 6)



Figure 6

7. Insert $\frac{1}{2}$ " x 1.75" bolts with flat washers and lock washers (50413-HW) through frame and into weld nuts in 23034 mounting bracket. Do not tighten.

8. Insert four (4) $\frac{1}{2}$ " x 1.75" bolts each with two (2) flat washers, one (1) lock washer, and one (1) hex nut (50413-HW), through the side of bracket and side of frame (two bolts per side). (Figure 7)



Figure 7

9. Tighten all hardware in steps 7-8 using $\frac{3}{4}$ " socket and combination wrench.

10. Repeat steps 7-9 for opposite side bracket.

-
11. If equipped, remove OEM ACC bracket from inside DS of bumper by removing four (4) 8mm bolts. (Figure 8)



Figure 8

12. Insert 23044 into front DS of OEM bumper and 23045 into front PS of OEM bumper where tow hooks were located. Add 2 – ¼" spacer between bracket and OEM bumper bracket. Tape may be used to keep spacers in place while installing brackets. (Figure 9)

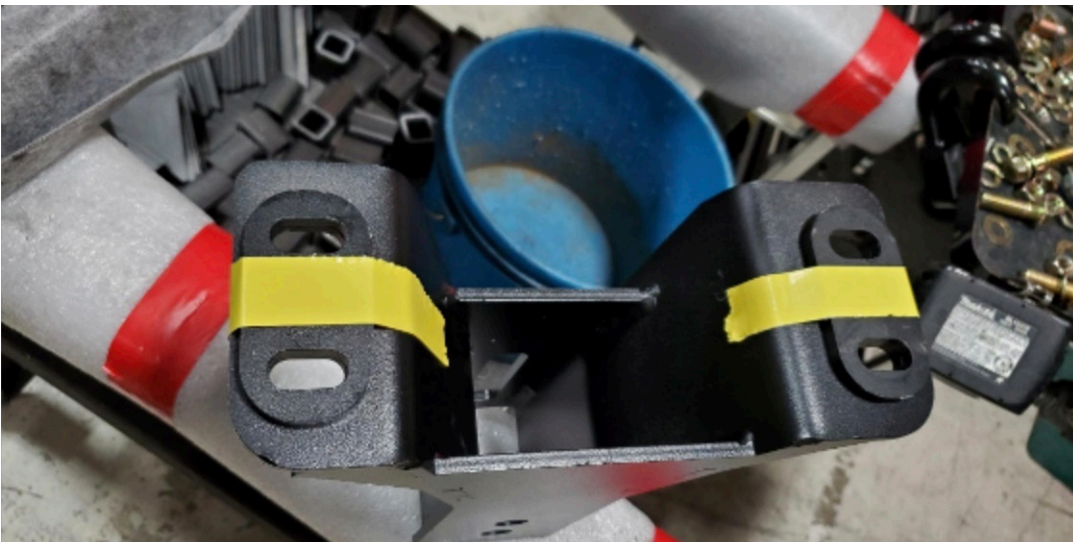

Figure 9

13. With assistance, lift OEM and bumper and mounting brackets up to truck. Align holes in 23044 & 23045 mounting brackets with OEM bumper brackets and 23034 & 23035 brackets installed in steps 6-9.

14. Insert $\frac{1}{2}$ " x 2.25" bolts with flat washer, through four (4) holes in each side. Secure flat washer, and lock washer on inside of bumper with $\frac{1}{2}$ " hex nut. (Figure 10)



Figure 10

15. Align OEM bumper into proper position and tighten bolts installed in step 14 using $\frac{3}{4}$ " socket and combination wrench.

16. Install winch into winch mount. Refer to winch mounting instructions.

17. With assistance, lift winch mount (23041) into position. Align holes in bottom of winch mount with weld nuts in 23044 & 23045 mounts. Attach tow hook (61366) to bottom of winch mount using 1/2" x 2.25" bolts, flat washers, lock washers (50413-HW). (Figure 11 & 12)



Figure 11



Figure 12

INSTALLATION COMPLETE

CONTACT INFORMATION

**FAB FOURS INC.
2213 INDUSTRIAL PARK ROAD
LANCASTER, SC 29720**

PHONE: (866) 385-1905

FAX: 970-385-1914

EMAIL: SUPPORT@FABFOURS.COM

FABFOURS.COM



**“IF YOU’RE LOOKING FOR MORE OF THE SAME,
THEN YOU’VE COME TO THE WRONG PLACE.”**

- GREG HIGGS

