



INSTALLATION MANUAL
VENGEANCE FRONT BUMPER
PRODUCT NUMBER: V445X
APPLICATION: 2019+ DODGE HD



IMPORTANT SAFETY GUIDE | Your safety and the safety of others is very important.

In order to help you make informed decisions about safety, we have provided the following warnings, safety precautions, installation instructions, and other important information to alert you to potential hazards that could hurt you or others.

Please do a job safety analysis before each task to identify potential hazards for your situation and remove/protect against them. Use own good judgment and take your time.

Check packaged materials immediately upon arrival to ensure that all listed parts are included and undamaged.

Read and understand all warnings, safety precautions, and instructions before installing this product.

SENSORS FIELD OF VIEW MAY BE ALTERED WITH USE OF THE REPLACEMENT BUMPER.

WARNINGS

- Failure to observe the following warnings and instructions provided in this manual could lead to severe injury and/or death.
- For professional installation only. Careless installation and/or operation can result in serious injury, death, and/or equipment damage. All liability for installation and use rests with the user or consumer.
- Fab Fours, Inc. only approves installing this product according to these written instructions with the hardware provided. Failure to install according to these instructions will invalidate the warranty. This includes, but is not limited to, using alternative installation methods, hardware, or materials.
- This product is for off road use only.

SAFETY PRECAUTIONS

- Always remove jewelry and wear eye protection.
- Always use extreme caution when jacking up a vehicle for work. Set emergency brake and use tire blocks. Locate and use the vehicle manufacturers designated lifting points. Use jack stands.
- Always use appropriate and adequate care in lifting components into place.
- Always ensure components will remain secure during installation and operation.
- Always wear safety glasses when installing this kit. A drilling operation will cause flying metal chips. Flying chips can cause serious eye injury.
- Always use extreme caution when drilling a vehicle. Always disconnect power before welding. Thoroughly inspect the area to be drilled (on both sides of material when possible) prior to drilling, and relocate any objects that may be damaged.
- Always use extreme caution when welding a vehicle. Thoroughly inspect the area to be welded (on both sides of material when possible) prior to welding, and relocate any objects that may be a fire hazard. When welding in a cab, make sure the interior surfaces are covered (e.g., welding blanket) and a fire extinguisher is at hand.
- Always use extreme caution when cutting and trimming during fitting.
- Always tighten all nuts and bolts securely per installation instructions.
- Always route electrical cables carefully. Avoid moving parts, components that become hot, and rough or sharp edges.
- Always insulate and protect all exposed wiring and electrical terminals.
- Perform regular inspections and maintenance on mounts and hardware.

TABLE OF CONTENTS

- 2 SAFETY / DISCLAIMER
- 3 TABLE OF CONTENTS
- 4 A MESSAGE FROM THE OWNER
- 5 GETTING STARTED
- 6 PROVIDED MATERIAL
- 7 DISASSEMBLY
- 12 INSTALLATION
- 15 CONTACT

A MESSAGE FROM THE OWNER



Fab Fours' was born out of a passion for customizing vehicles and a love of the outdoors. Our engineering team uses the latest 3D design software to turn new product ideas into reality. In our factory, designs come to life with the combination of cutting edge technology for metal cutting and forming and an American workforce that puts its' heart and pride into every product.

From design and manufacturing, to quality and delivery, Fab Fours' mission is to be the market leader for steel truck and jeep accessories. We make sure a quality product is delivered on time, more than expected, better than expected to our customers.

Enjoy your new Fab Fours product. Welcome to the family!

Ereg Higgs

FOUNDER, FAB FOURS

GETTING STARTED

Before you begin the installation process of your new Fab Fours product, we suggest laying out all materials and parts on a pad or protective surface.

Failure to fully account for all components before beginning installation may leave vehicle immobile until part is acquired. Refer to the next pages as an inventory check.

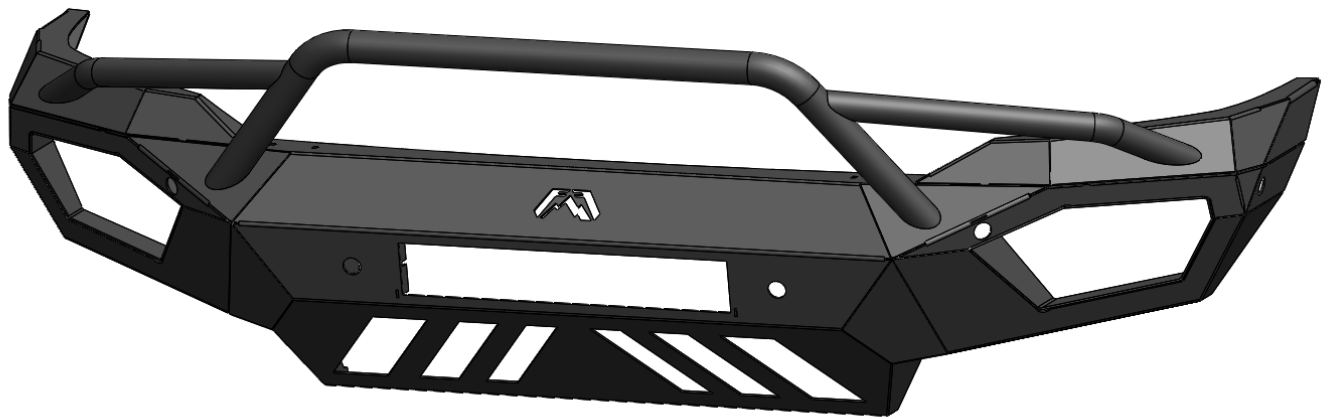

PROVIDED MATERIALS

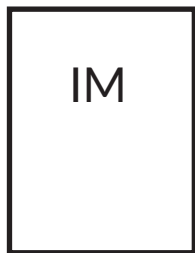

V445XX-IM

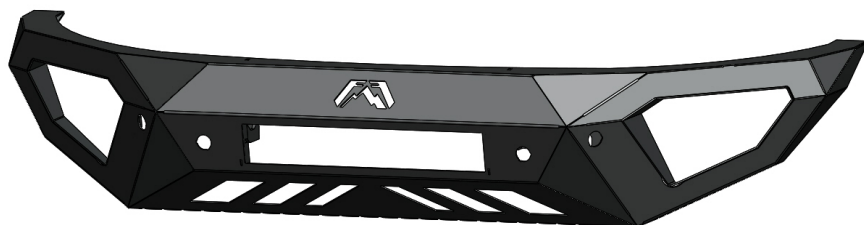

21881

TOOLS REQUIRED

- Plastic panel pry tool
- 8mm socket wrench
- 10mm socket wrench
- 15mm socket wrench
- 21mm socket wrench
- 9/16" socket wrench
- Flat head screw driver
- Zip ties

ASSISTANCE

We recommend two people perform the installation as items are heavy and may need to be held in place while installing.

ORGANIZATION

Disassemble the vehicle where you can catalog and store everything. We suggest labeling and bagging all the OEM bolts when removing from the vehicle. Failure to keep track of parts could lead to an inability to properly reinstall components.

DISASSEMBLY

NOTE: Sensors are extremely delicate and must be handled with care! Do not push on face of sensors to remove!

1. Disconnect the IBS sensor connection from sensor on the negative battery terminal. (Figure 1, #1)

2. Using a 10mm socket wrench, disconnect the negative terminal from the battery. (Figure 1, #2)

3. If applicable, disconnect the negative terminal from the auxiliary battery. (Figure 2)

4. Using an 8mm Socket wrench and plastic panel pry tool, remove the two (2) screws and one (1) push pin from the rear splash shield trim. (Figure 3)

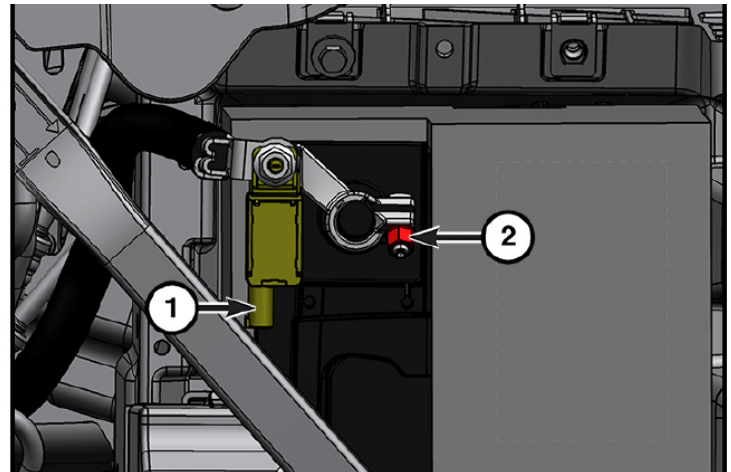

Figure 1

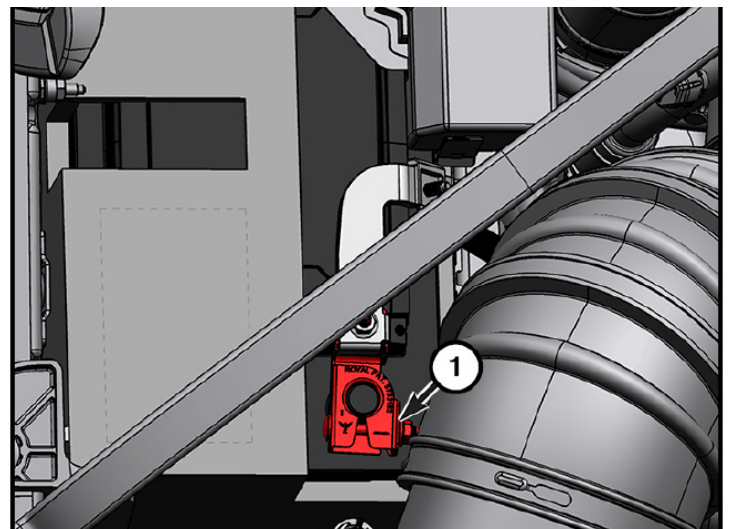

Figure 2

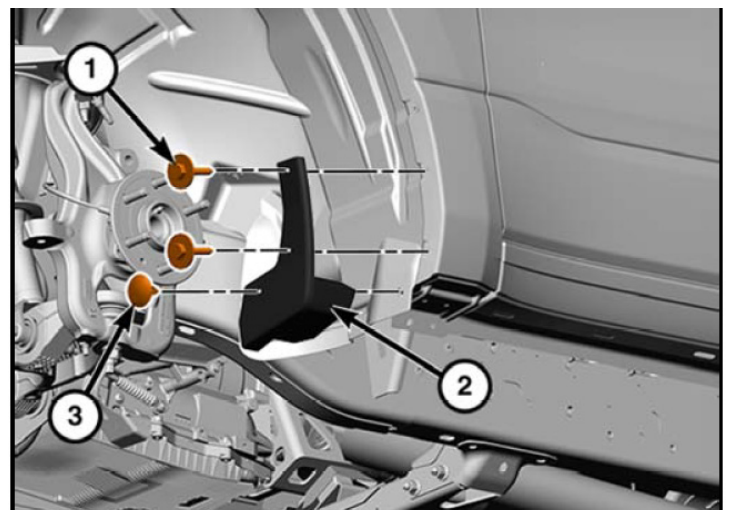

Figure 3

5. Using an 10mm socket wrench and plastic panel pry tool, remove the twelve (12) screws and two (2) push pins from the inner fender and set aside for trimming. (Figure 4 and 5)

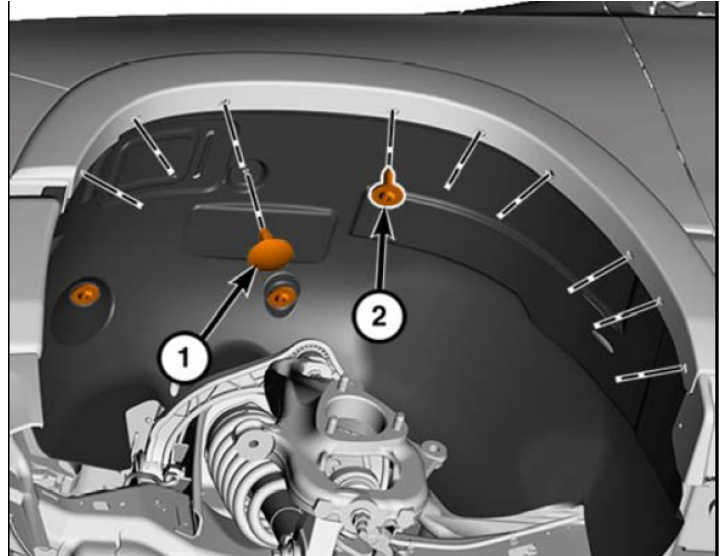

Figure 4

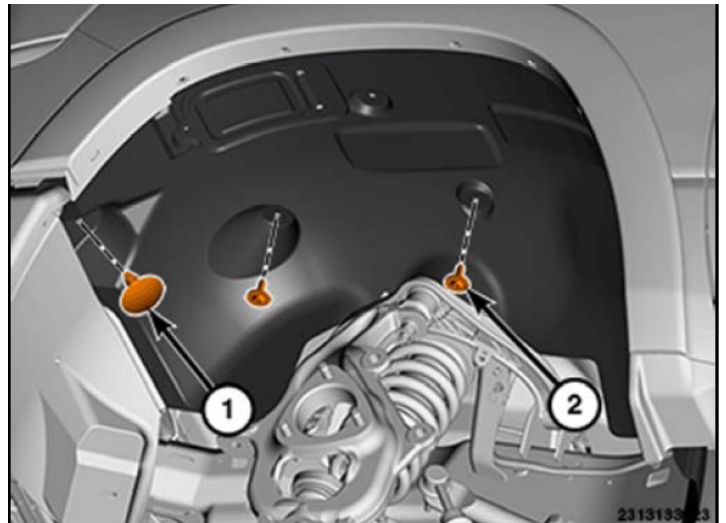

Figure 5

6. Disconnect the factory wiring harness from the inside of the driver side wheel well (Figure 6)

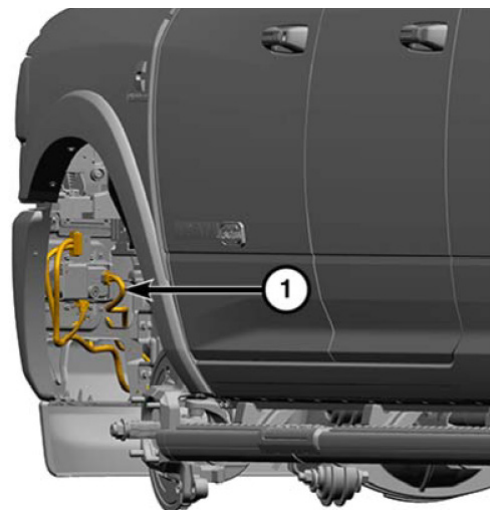

Figure 6

7. With assistance, support the bumper from both sides of the vehicle. Using an 18mm socket wrench, 24mm socket wrench and 18mm open end wrench, remove the three factory bumper bolts that hold the factory bumper to the frame rail. (Figure 7)

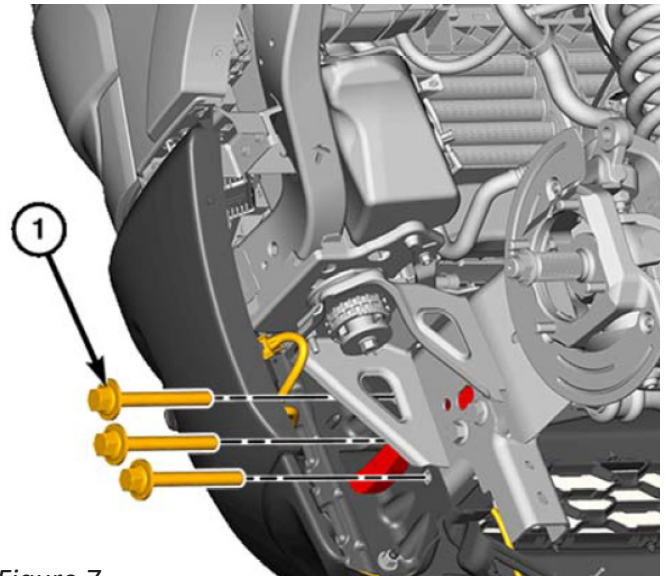

Figure 7

8. Remove the factory bumper from the vehicle and set aside. (Figure 8)

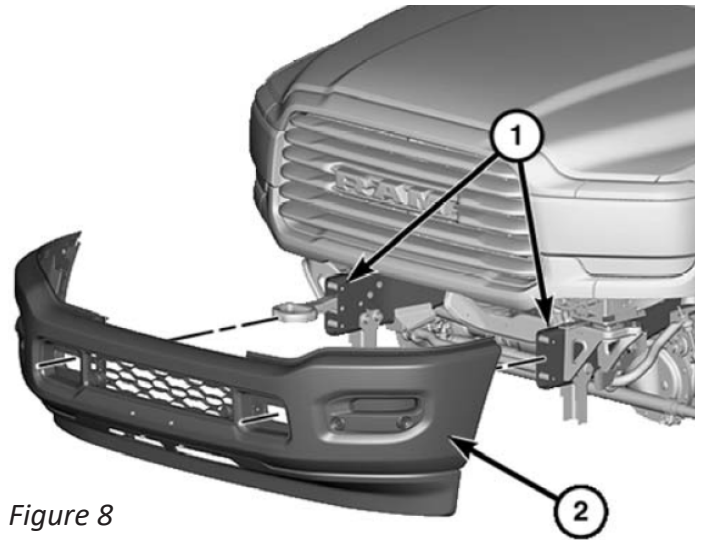

Figure 8

9. Using a 24mm socket wrench, remove the factory bolt and nut tab from the frame rail to remove the factory tow hook. (Figure 9)

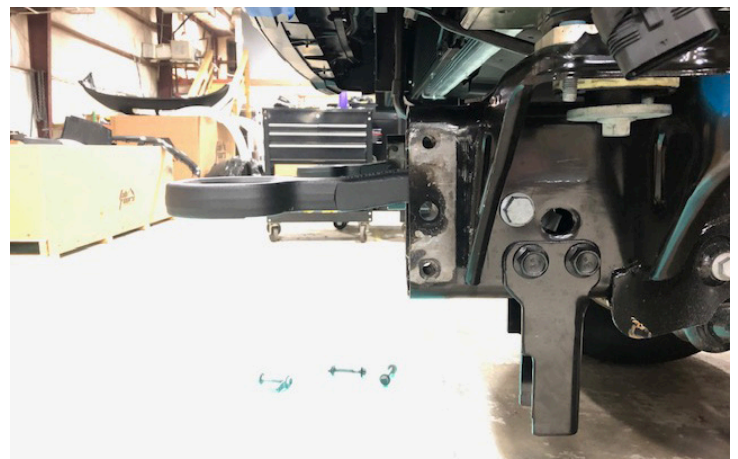

Figure 9

10. Remove the factory tow hooks.

11. Unclip the factory wiring harness from the six (6) front sensors and two (2) fog lights.

12. Remove the sensor from the sensor housing by expanding both sides of the sensor housing and lifting up. (Figure 10-11)



Figure 10



Figure 11

13. Remove the sensor housing from the bumper by depressing the four (4) tabs while pulling outward from the outside of the bumper. (Figure 12-13)



Figure 12



Figure 13

14. Using a plastic panel pry tool, begin removing the factory wiring harness from the factory bumper by unclipping the various push pins. (Figure 14-16)

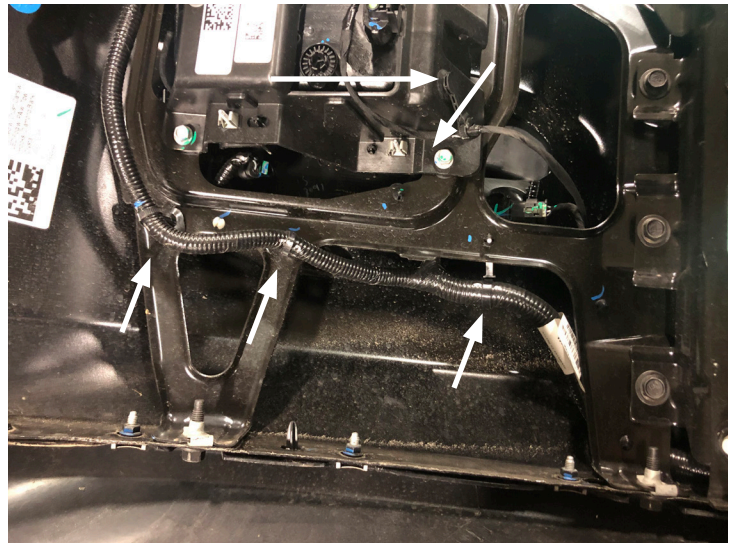

Figure 14

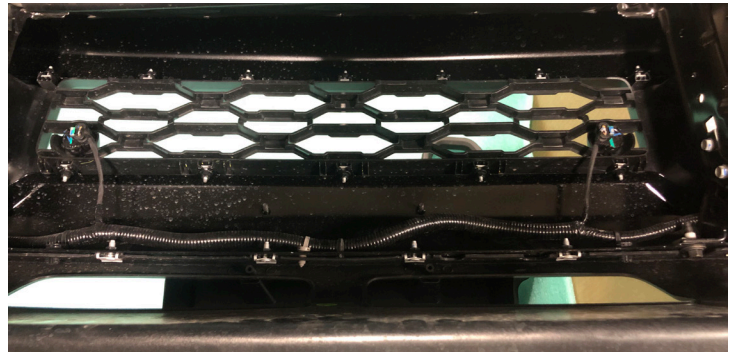

Figure 15

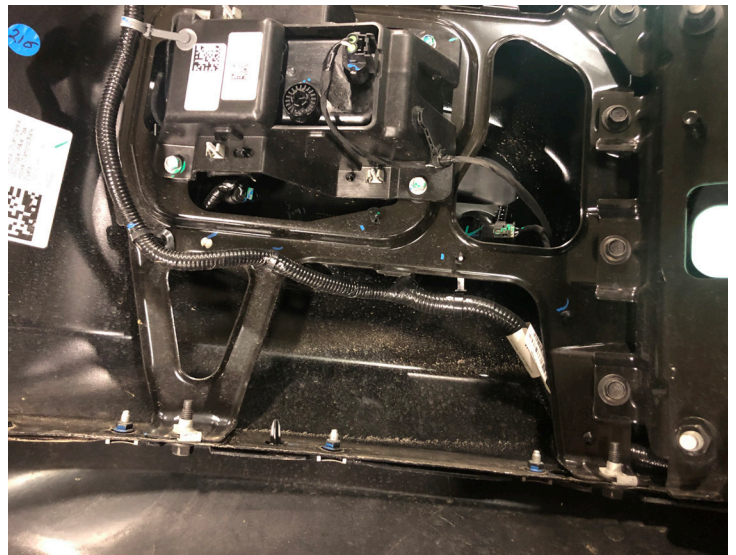

Figure 16

15. Remove the factory wiring harness and set aside. (Figure 17)

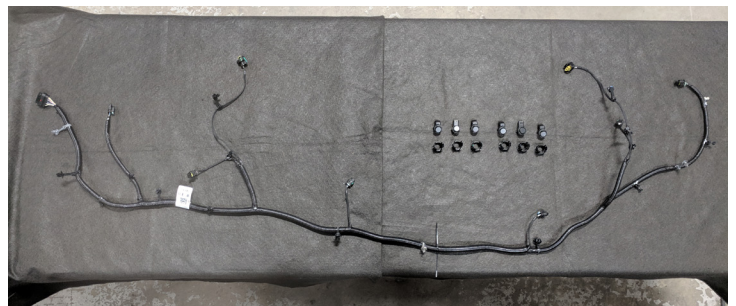

Figure 17

INSTALLATION

16. If installing accessory lighting do so now using the lighting manufactures instructions and hardware.

NOTE: Not all the sensors or housings are the same. Use the two (2) flat sensors housings for the center two holes and the four (4) dished sensor housings for the outer four holes. Be mindful to install the correct sensor unit as shown.

17. Install the two (2) flat faced sensor housings and 90 degree sensors into the center two (2) sensors holes. (Figure 18)



Figure 18

18. Install the one (1) dished faced sensor housing and one (1) straight sensor into the passenger side inner wing sensor hole. (Figure 19)

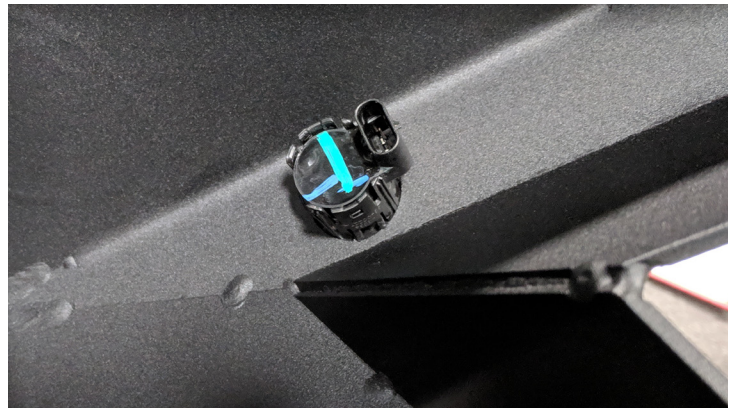

Figure 19

19. Install the one (1) dished faced sensor housing and one (1) 90 degree sensor into the passenger side outer wing sensor hole. (Figure 20)



Figure 20

20. Repeat steps 3 and 4 to install the driver side sensors in the same manor.

21. Fish the factory wiring harness through both the large pass through holes in the brackets and with the main factory wiring harness connector ending on the driver side of the bumper.

22. Reconnect the factory wiring harness to all six (6) sensors and zip tie the wiring harness to the zip tie points built into the shell. (Figure 21-22)



Figure 21



Figure 22

23. With assistance, support the bumper up to the frame rail and insert the four factory bumper bolts with the factory nut. (Figure 23)

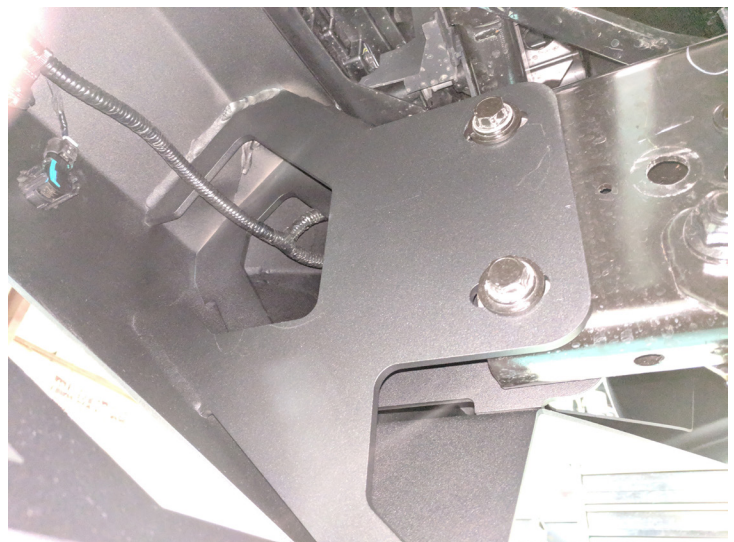

Figure 23

24. With assistance, align the bumper to fender gap. Using an 18mm socket wrench and 18mm open end wrench, fully tighten all four (4) factory bumper bolts.

25. Reconnect the factory sensor wiring harness to the main harness.

CONTACT INFORMATION

**FAB FOURS INC.
2213 INDUSTRIAL PARK ROAD
LANCASTER, SC 29720**

PHONE: (803) 416-1100

FAX: 970-385-1914

EMAIL: SUPPORT@FABFOURS.COM

WWW.FABFOURS.COM



**“IF YOU’RE LOOKING FOR MORE OF THE SAME,
THEN YOU’VE COME TO THE WRONG PLACE.”**

- GREG HIGGS

