

INSTALLATION GUIDE

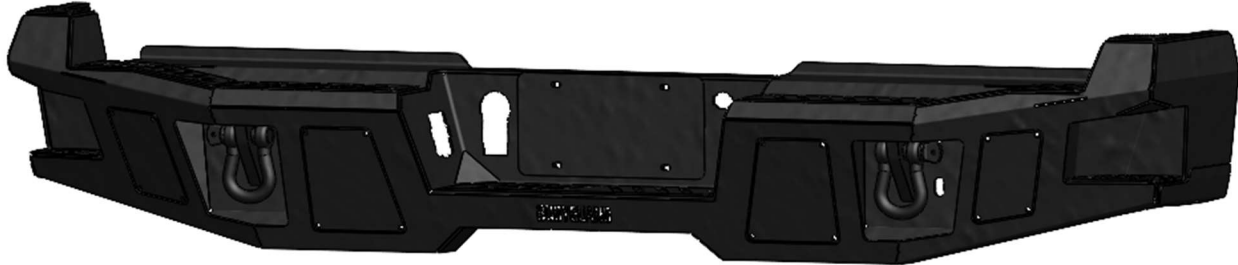

SAFETY

THE SAFETY OF YOU AND OTHERS IS VERY IMPORTANT TO US!

To minimize this risk and make an informed decision about safety, it is important that you carefully read and follow the installation instructions we have provided.

We urge you to use your own good judgment and allow plenty of time for install.

HAZARD CHECKLIST

1. Always wear personal protective equipment (PPE) such as: protective eye wear, gloves, close toed shoes, etc.
2. We recommend that you use a certified mechanic or shop for professional installation.
3. Always set emergency brakes on vehicle and use tire blocks to ensure vehicle stabilization.
4. Use caution when lifting, we recommend the use of equipment to help lift bumpers into place.
5. Use caution when using power tools such as air ratchet, etc.
6. Take caution when installing wiring.
7. Perform regular inspections of hardware, bolts, brackets, etc.
8. Rigid light brackets are specifically designed to fit Rigid lights, we do not guarantee off brand fitment.
9. Our winch mount is designed for Warn and Superwinch products. We do not guarantee off brand fitment.

USE & RISK

Bodyguard Products LLC is not responsible for damage to our products, or other subsequent damage that might occur, as a result of misuse or improper installation. While we do manufacture products that appear stronger than factory parts, our products should not be viewed or relied upon as life-saving devices in the event of a collision or rollover. We make no claims relating to airbag compatibility, crashworthiness, or sturdiness. It is the customer's responsibility to check with the vehicle manufacturer or auto dealer regarding airbag compatibility and automobile manufacturer's warranty before installing our products.

PREPARATION

- Ensure personal safety by checking for hazards and identifying risks.
- Check for correct hardware.
- Check for tools needed.
- Use either foam or tape on fenders to prevent scratches to the truck when installing your bumper.
- Please allow approximately 3-4 hours for installation.
- Disconnect the battery.

TOOLS

- 1** - Jack
- 2** - Safety Stands
- 2** - Wheel Chocks
- 1** - Wire Cutters & Wire Crimpers
- 1** - Small Pry Tool
- 1** - Tape measure
- 1** - Pliers
- 1** - Metric Wrench/Sockets –15mm, 21mm, 19mm, allen wrenches or sockets
- 1** - Level

BUMPER COMPONENTS

- 1** - Main Bumper Section
- 2** - Bumper Frame Mounts
- 2** - Inner Parking Sensor Plates
- 2** - Outer Parking sensor plates
- 2** - Inner Step Pads
- 2** - Outer Step Pad
- 1** - Center Step Pad

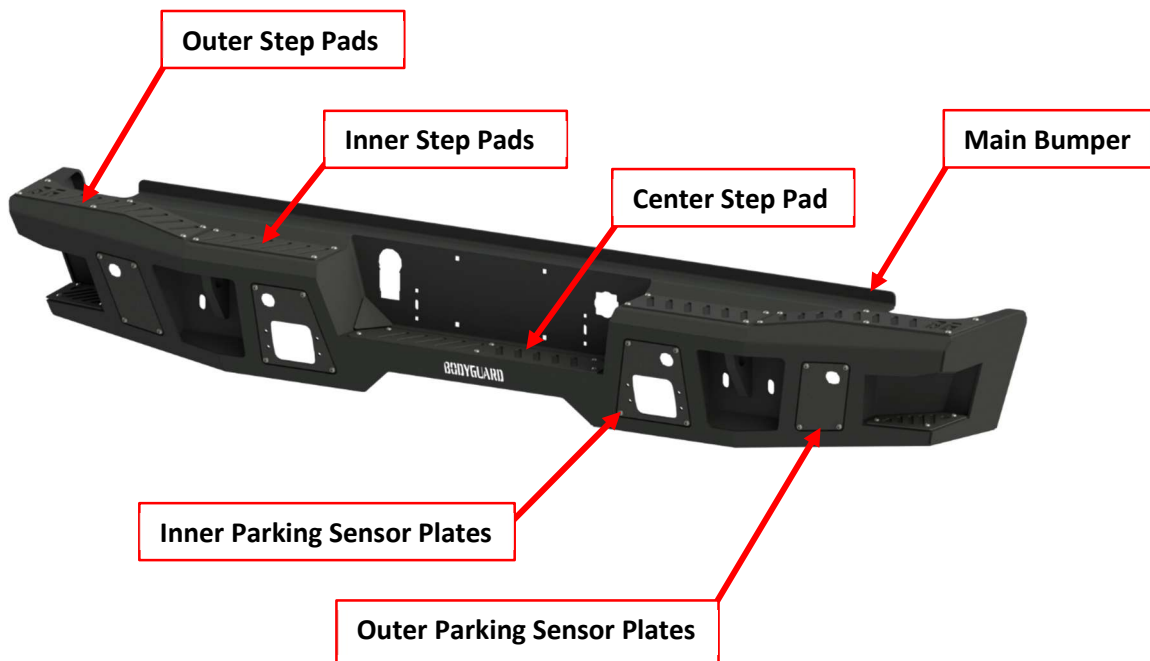

HARDWARE

T1-HK-LPR	All Rear Bumpers	Qty.
	Plastic License Plate Nuts	4
	#14 x 5/8" Zinc License Plate Screw	4
	Plastic Wire Splices	4
	Tag Lights	2
	Tag Light Screws	4
	Plastic License Plate Nut	4
A2-HK-FRH17	A2 Rear Mount Kit 17+ Ford SD	Qty
	1/2-13 x 1-1/2 Long, Grade 8 HB Zinc-Yellow	10
	1/2" Washer, Grade 8 Zinc-Yellow	24
	1/2"-13 Grade 8 Steel Serrated Flange Nut Zinc	16
	1/2"-13 x 1-1/2" Stainless Steel Hex Bolt	8
	1/2" Stainless Steel Flat Washer	8
	1/4-20 x 5/8 Long, Stainless Steel SBHCS	60
	1/4-20 Hex Grade 5 Serrated Flange Nut, Stainless Steel	60
	1/4 Clip Nut	4

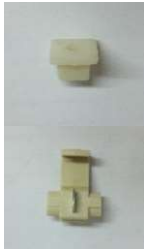

Plastic License Plate Nut

Plastic Wire Splice

BUMPER REMOVAL

1. Disconnect the wiring harness from the 7 pin trailer plug on the inside of the bumper.
2. Disconnect the backup sensor and the license plate wiring harness.



3. Using a 15mm socket, remove the (2) bolts in the center of the bumper.
4. Using a 21mm socket, remove the (6) nuts and flag bolts from the frame on the driver and passenger side of the bumper. *(Retain these bolts and nuts for installation of Bodyguard bumper mounts)*



17-22 ONLY! DO NOT REMOVE FOR 23.

5. Remove the bumper from the vehicle.
6. Remove the (12) bolts in the bumper support brackets on the driver and passenger side using a 45 Torx bit.
7. Unclip the 7 pin trailer plug from the bumper and remove. *(Retain plug for later use)*

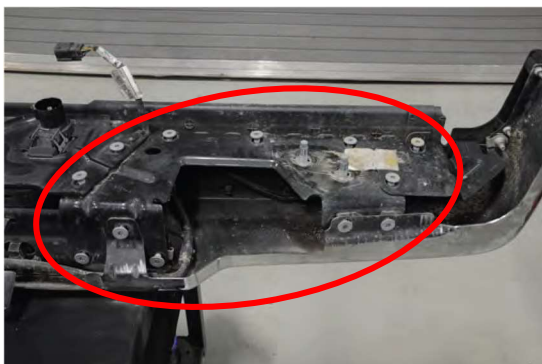

8. Then remove the support brackets in place to gain access to parking sensors and wiring harness.
9. Disconnect the parking sensors and license plate light plugs.

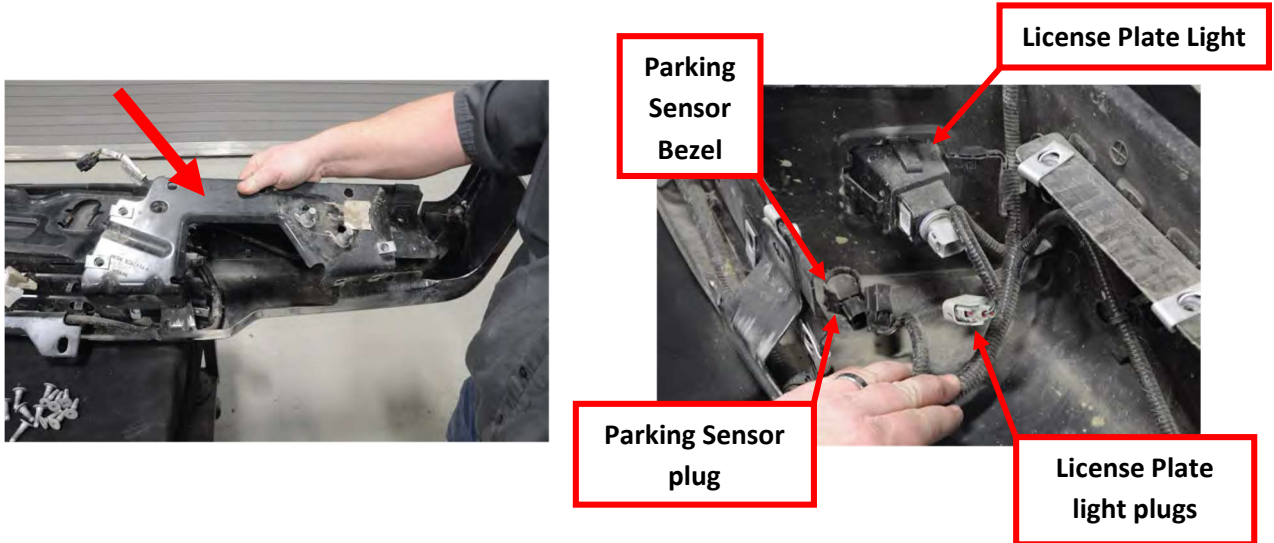

10. Remove the wiring harness from the bumper. (Retain harness for later use)
11. Use care and a pry tool, remove the parking sensors and bezels, and license plate lights from the bumper.



12. Use the ignition key to remove the spare tire lock from the bumper.



BUMPER INSTALL

1. Prior to attaching bumper: Install the top, center, and corner step plates in their correct position (*inner/outer/driver/passenger*) using the 1/4-20 x 5/8 Long, Stainless Steel (35x) (*NOTE: STEP PLATES MAY HAVE BEEN PRE-INSTALLED AT POINT OF MANUFACTURE*)



2. Install the 7-pin trailer plug and the license plate lights into the bumper.
3. Install and route the parking sensor harness through the bumper.
4. Install the plastic sensor bezels removed from the factory rear bumper into the sensor plates.
5. Once bumper is in place, secure the sensors and sensor plates in their correct orientation (*inner/outer/driver/passenger*).



Sensor plates need to be positioned so that the machined face is to the inside of the bumper like shown below. If installed incorrectly the backup sensors may not function correctly.

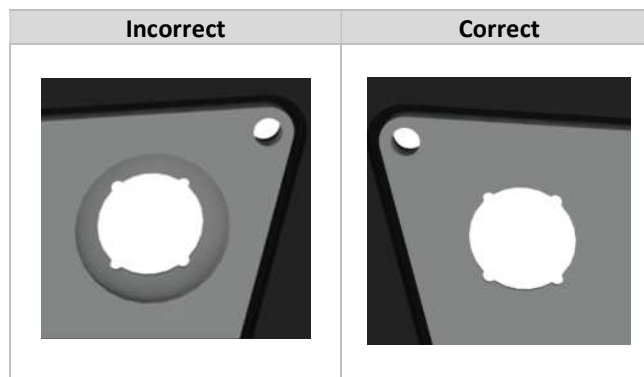

*Sensor cutout will vary from image shown above

6. Install the spare tire lock into the bumper.

MOUNT INSTALL

1. Use the factory flag bolts and nut hardware to install the Bodyguard bumper mounts onto the frame loosely.

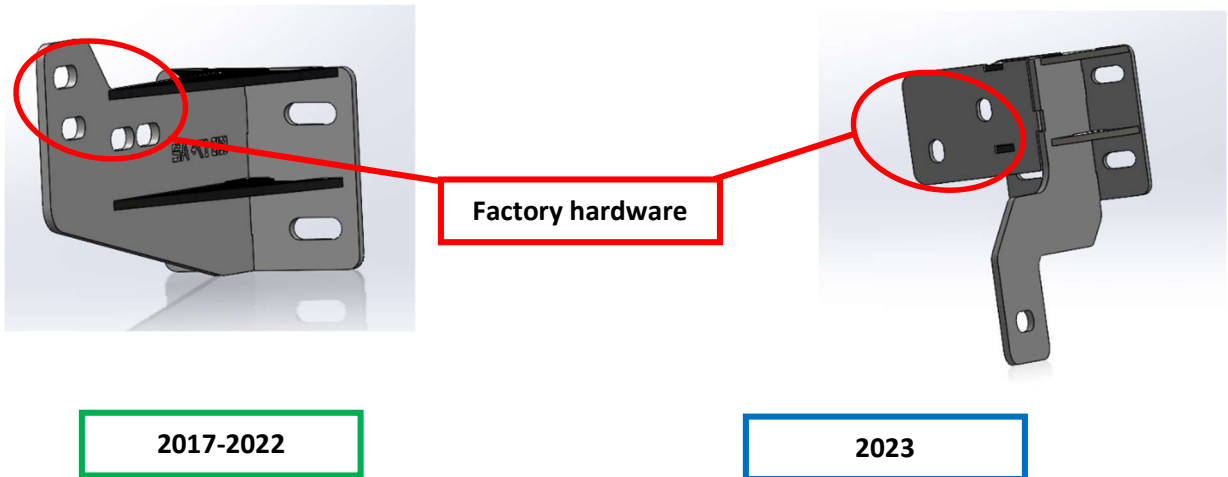

BUMPER INSTALL CONTINUED

1. Attach the bumper to the mounts with the 1/2"-13 x 1-1/2" Stainless Steel Hex Bolt hardware, leaving enough space to adjust the bumper as needed into position. Using a tape measure, adjust the bumper vertically and horizontally to the desired body gaps. Once the bumper is lined up, tighten all hardware for the bumper and the mounts. Using jack stands or an additional person to help support the bumper is recommended.

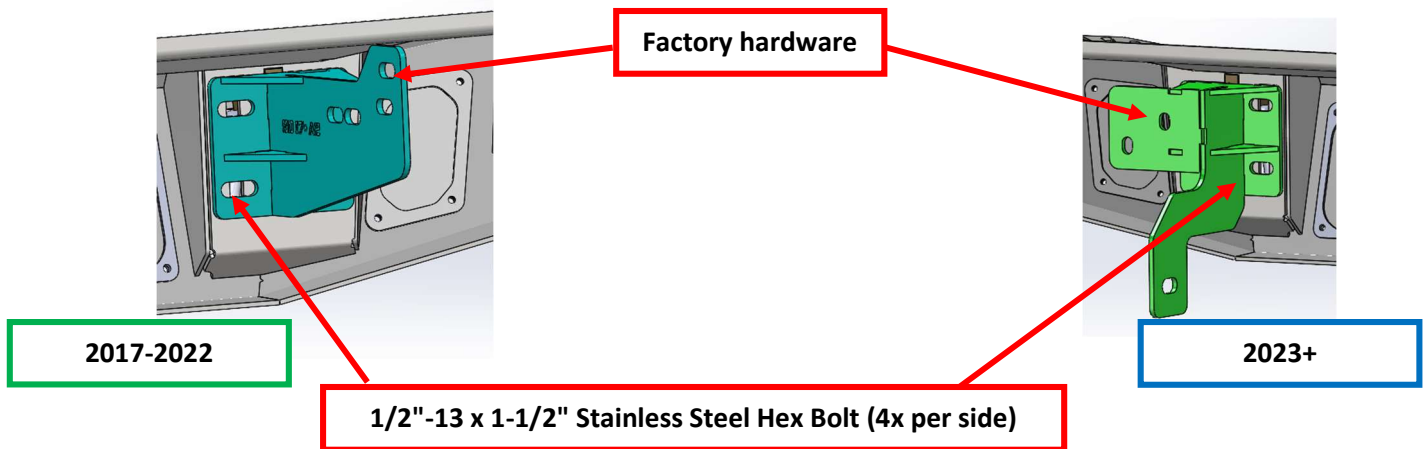

END CAP PLATE INSTALL

Install the end cap plates in their correct position (*driver/passenger*) using the 1/4-20 x 5/8 Long, Stainless Steel (4x) and either 1/4-20 Hex Flange Nut x4 (17-22) or 1/4 Clip Nut(2023).

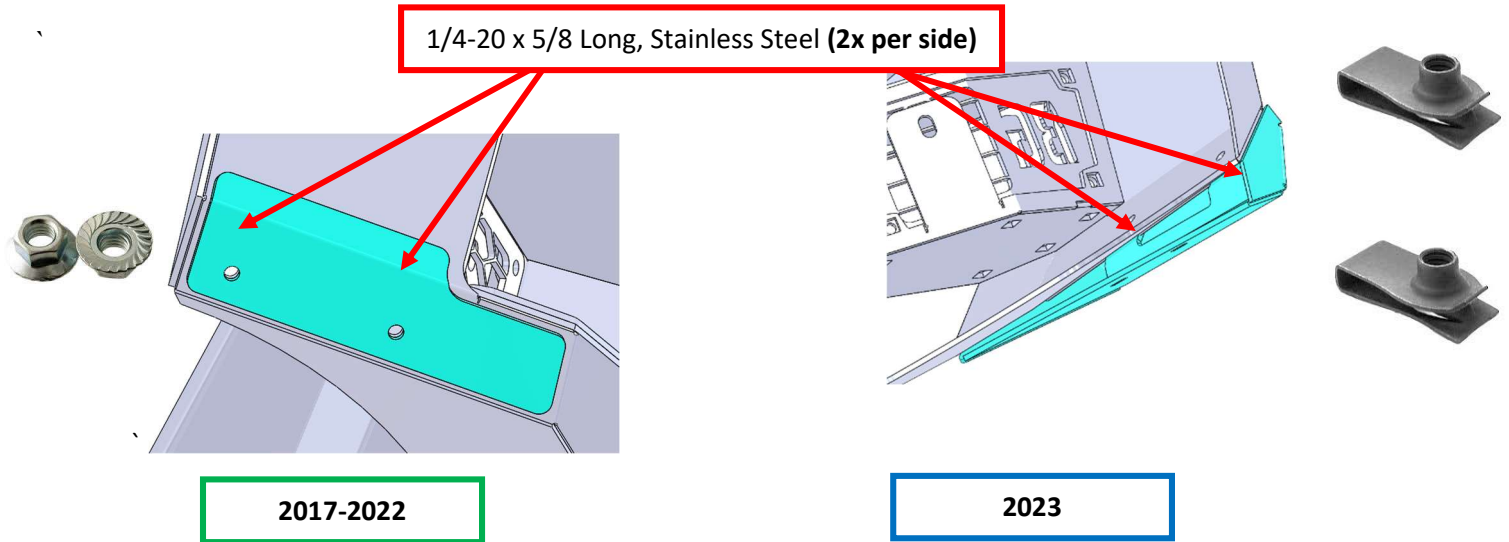

PARKING SENSOR PLATE INSTALL

NOTE: If you are installing LED backup lights, do that before installing the inner sensor plates

1. Placing the sensor plates in their correct orientation (*inner/outer/driver/passenger*) install the sensor plates onto the bumper using the 1/4-20 x 5/8 Long, Stainless Steel (18x)
2. Connect the wiring harness to the parking sensors and the license plate lights on each side of the bumper and the trailer light plug.

LICENSE PLATE INSTALL

1. Insert Plastic License Plate Nuts into bumper and mount license plate using the License Plate Screw and a power drill.

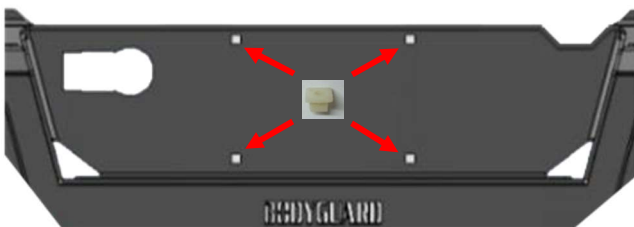

NOTE: Wire in reverse lights as desired and check operation.

FINISHING UP

- Install shackles.
- Confirm that all hardware is tightened and everything is secure.
- Secure wiring harnesses for lights and sensors.
- Test all lighting and wiring before using vehicle (fog lights, sensors, etc.).
- Reconnect the battery.

MAINTENANCE

- Periodically check that all hardware is tightened and that all wiring and connections are secure.
- Periodically check that all sensor plugs are secure.
- Routinely wash bumper to maintain the powder coat finish.

FEEDBACK

We'd love to hear from you!

Please send your pictures, testimonials, comments, or suggestions to us by email at info@bodyguardbumpers.com. We frequently use customer pictures for brochures and marketing materials, and we always welcome customer feedback to ensure quality improvements within our company. Thanks for your purchase; we appreciate your business very much!

Where **STRENGTH** Meets *Style!*™



@BodyguardBumpers