



INSTALLATION INSTRUCTIONS

ASCENT FRONT BUMPER

Part Number: 99777

Application: 2014-2017 Toyota Tundra

GENERAL SAFETY PRECAUTIONS

Your safety, and the safety of others, is very important. To help you make informed decisions about safety, we have provided installation and operating instructions and other information on labels and in this guide. This information alerts you to potential hazards that could hurt you or others. It is not possible to warn you about all potential hazards associated with this product, you must use your own good judgment.

CARELESS INSTALLATION AND OPERATION CAN RESULT IN SERIOUS INJURY OR EQUIPMENT DAMAGE. READ AND UNDERSTAND ALL SAFETY PRECAUTIONS AND OPERATING INSTRUCTIONS BEFORE INSTALLING AND OPERATING THIS PRODUCT.

This guide identifies potential hazards and has important safety messages that help you and others avoid personal injury or death. WARNING and CAUTION are signal words that identify the level of hazard. These signal words mean:

▲WARNING signals a hazard that could cause serious injury or death, if you do not follow recommendations. ▲CAUTION signals a hazard that may cause minor to moderate injury, if you do not follow recommendations.

This guide uses NOTICE to call attention to important mechanical information, and Note: to emphasize general information worthy of special attention.

▲ WARNING

IMPACT AND MOVING PARTS ENTANGLEMENT HAZARD

Failure to observe these instructions could lead to severe injury or death

- **Always** take time to fully read the Instructions and/or Operations Guide, and/or Basic Guide to Winching Techniques, in order to understand your winch and its operations.
- **Always** use extreme caution when drilling on any vehicle. Make sure that all fuel lines, brake lines, electrical wires, and other objects are not punctured or damaged when/if drilling on the vehicle. Thoroughly inspect the area to be drilled (on both sides of material) prior to drilling, and relocate any objects that may be damaged. Failure to inspect the area to be drilled may result in vehicle damage, electrical shock, fire or personal injury.
- **Always** wear safety glasses when installing this kit. A drilling operation will cause flying metal chips. Flying chips can cause eye injury.
- **Always** use extreme caution when cutting and trimming during fitting.
- **Always** remove jewelry and wear eye protection.
- **Never** lean over battery while making connections.
- **Never** route electrical cables:
 - o Across any sharp edges.
 - o Through or near moving parts.
 - o Near parts that become hot.
- **Always** insulate and protect all exposed wiring and electrical terminals.
- **Always** install terminal boots as directed in installation instructions.
- **Always** use appropriate and adequate care in lifting components into place.
- **Always** insure components will remain secure during installation and operation.
- **Always** tighten all nuts and bolts securely, per the installation instructions.
- **Always** perform regular inspections and maintenance on the plow mechanism, fasteners, cable and related hardware.
- **Always** replace all worn or damaged parts before operating.
- **Never** operate this WARN product with damaged or missing parts.

Read installation and operating instructions thoroughly.

WARN INDUSTRIES, INC. 12900 S.E. Capps Road,
Clackamas, OR USA 97015-8903, 1-503-722-1200, FAX: 1-503-722-3000
Customer Service: 1-800-543-9276
Dealer Locator Service: 1-800-910-1122
International Fax: 1-503-722-3005

⚠ CAUTION

MOVING PARTS ENTANGLEMENT HAZARD

Failure to observe these instructions could lead to minor or moderate injury

- **Always** take time to fully read and understand the installation and Operations Guide included with this product.
- **Never** operate this product if you are under 16 years of age.
- **Never** operate this product when under the influence of drugs, alcohol or medications.

Read installation and operating instructions thoroughly.

NOTICE

EQUIPMENT DAMAGE

- **Always** refer to the Installation and Specification Guide, supplied in the winch kit, for all wiring schematics and specific details on how to wire this WARN product to your vehicle.

Read installation and operating instructions thoroughly.

BEFORE YOU BEGIN

NOTICE



This product may interfere with driver assist systems such as adaptive cruise control and parking assist systems that have sensors or cameras installed in the bumpers or front grill area. If your vehicle is equipped with any of these systems or features, consult your vehicle owner's manual before installing this product. These systems may need to be disabled as a result of installing this product.

TABLE OF CONTENTS

Tools Required.....	page 2
Torque Specifications.....	page 2
Parts List.....	page 3
Installation.....	page 4-12
Maintenance/Care.....	page 12

TOOLS REQUIRED

- Standard wrenches
- Standard sockets

TORQUE SPECIFICATIONS

Please use the recommended torque specifications when assembling this product unless otherwise specified in the instructions.

FASTENER SIZE	FASTENER TORQUE		FASTENER SIZE	FASTENER TORQUE	
	lb-ft	(N.m)		lb-ft	(N.m)
1/4"	8	(11)	M4	(2)	3
5/16"	17	(23)	M5	(4.5)	6
3/8"	30	(40)	M6	(7.5)	10
7/16"	48	(66)	M8	(18)	25
1/2"	74	(100)	M10	(37)	50
9/16"	106	(144)			
5/8"	148	(200)			
3/4"	269	(364)			

PARTS LIST

ITEM	PART NO.	DESCRIPTION	QTY	ITEM	PART NO.	DESCRIPTION	QTY
A1	100517	BUMPER	1	B1	1323	1/2-13 HEX NUT	10
A2	99781	FRAME BRACKET TUNDRA LH	1	B2	1828	3/8-16 HEX NUT	12
A3	99790	FRAME BRACKET TUNDRA RH	1	B3	1829	3/8 LOCK WASHER	12
A4	99785	BRACKET SIDE SUPPORT TUNDRA LH	1	B4	2146	7/16 LOCK WASHER	4
A5	99786	TOP SUPPORT TUNDRA LH	1	B5	2583	7/16-14 HEX NUT	4
A6	99792	TOP SUPPORT TUNDRA RH	1	B6	2596	1/2 LOCK WASHER	10
A7	99793	BRACKET SIDE SUPPORT TUNDRA RH	1	B7	6960	3/8-16 X 1-1/4 HEX CAPSCREW	12
A8	99787	CRUSH TUBE TUNDRA	2	B8	7676	7/16 WIDE WASHER	8
A9	95438	LIGHT BRACKET LH	1	B9	9213	1/2 NARROW WASHER	24
A10	95458	LIGHT BRACKET RH	1	B10	11294	1/2-13 X 2 HEX CAPSCREW	8
A11	94888	LIGHT BEZEL RH	1	B11	11524	3/8 NARROW WASHER	24
A12	94889	LIGHT BEZEL LH	1	B12	15834	7/16-14 X 1-3/4 HEX CAPSCREW	4
				B13	22535	1/2-13 X 1-3/4 HEX CAPSCREW	8
				B14	91541	10-24X1-STAINLESS SCKT HD CAP SCREW	22
				B15	710269	1/2-13 X 4-1/2 HEX CAPSCREW	2
				B16	98139	11GA SPACER PLATE	3
				B17	98141	.25" SPACER PLATE	2
				B18	99591	FRAME SPACER PLATE	4
				B19	96546	SENSOR HOLE PLUG	2
				B20	100661	9/16 LOCKING PLUG	6

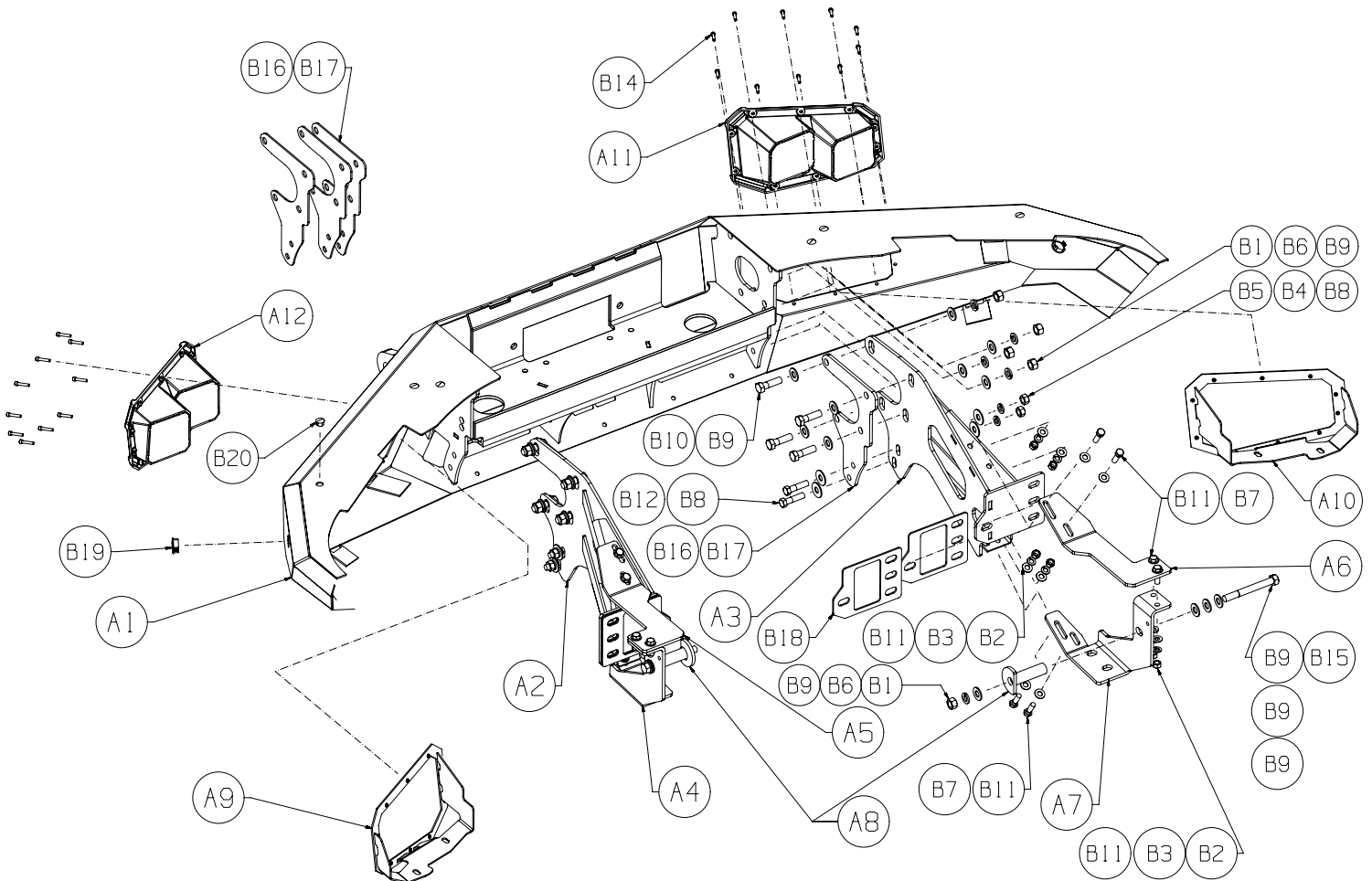

INSTALLATION INSTRUCTIONS



Figure 1

1. Remove one plastic clip from fender liner (both sides).



Figure 2

2. On each side, remove the two bolts securing tow hook and remove tow hook and set aside. **Save tow hook and bolts for reuse.**



Figure 3

INSTALLATION INSTRUCTIONS

3. Remove three screws holding bumper to skid pan.
Optional: Remove skid pan to increase access for upcoming installation.

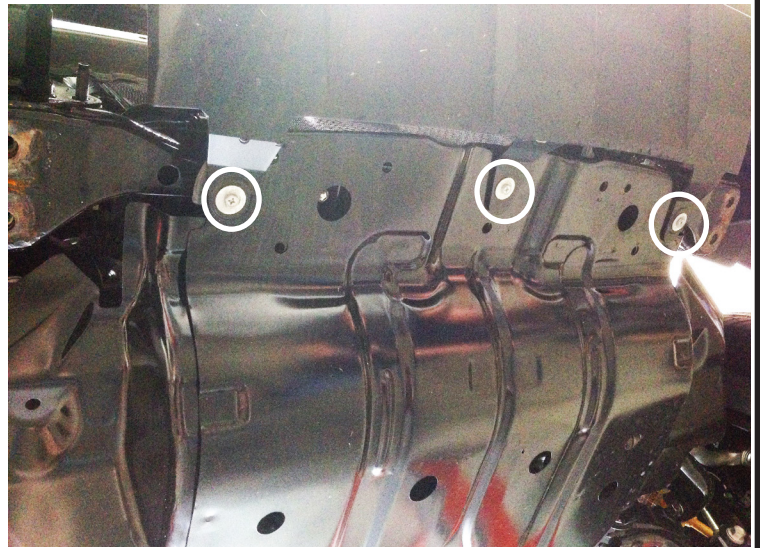

Figure 4

4. Locate and remove the four nuts holding bumper structure to frame rails (each side). Save nuts for reuse.

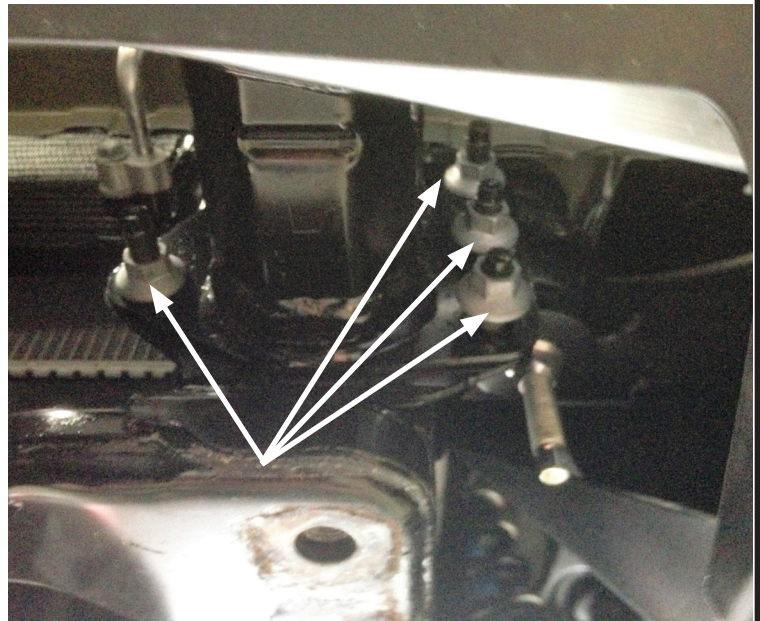

Figure 5

CAUTION

- Always use assistance when moving or lifting heavy parts.

5. *If equipped*, disconnect harness from rear of fog lamps and disconnect park sensor harness (both sides).
6. Remove and set aside bumper.



Figure 6

7. Install left and right frame brackets A2 and A3 using factory nuts removed previously. Leave nuts slightly loose for upcoming steps.

NOTE: It is highly recommended to install at least one frame spacer B18 on each side underneath the frame brackets.

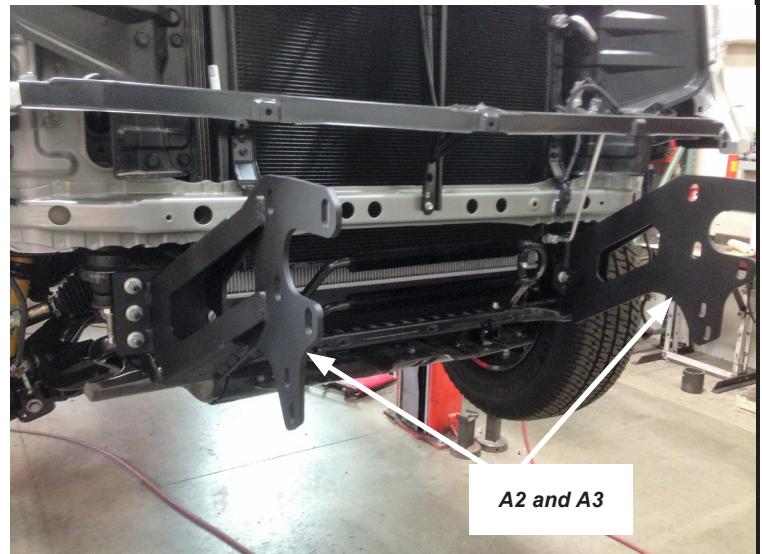

Figure 7

8. Unclip and remove indicated frame plug from both frame rails.

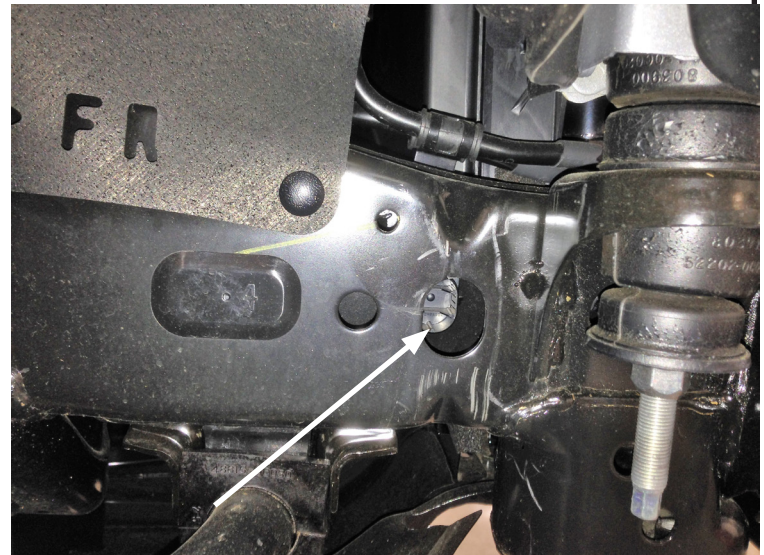

Figure 8

9. Install frame crush tube A8. Orient tube as shown, to clear radiator and slide tube in from back side. **NOTE: Removing skid pan will provide additional access to this area.**

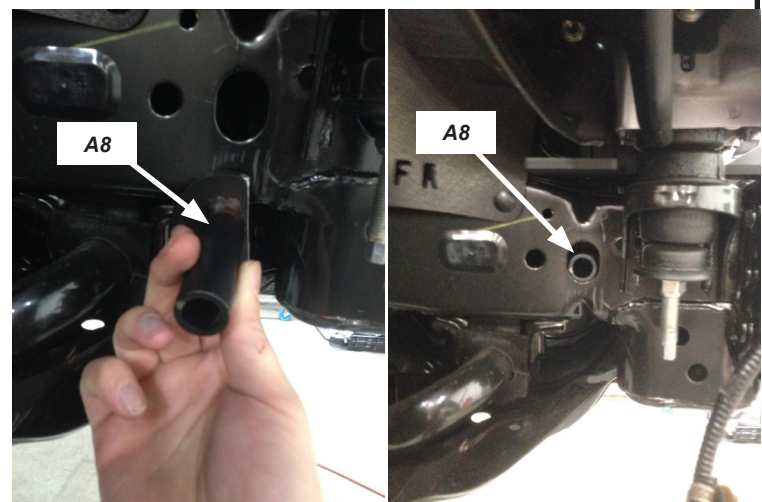

Figure 9

INSTALLATION INSTRUCTIONS

10. Install left and right top support brackets A5 and A6, by slipping brackets in from the front of frame rail. Review exploded view on page 3.

NOTE: If vehicle is equipped with cooler lines, they would be present on passenger side frame rail. If cooler lines contact the top support bracket, gently bend the support clip holding them to ensure they do not contact top support in use.

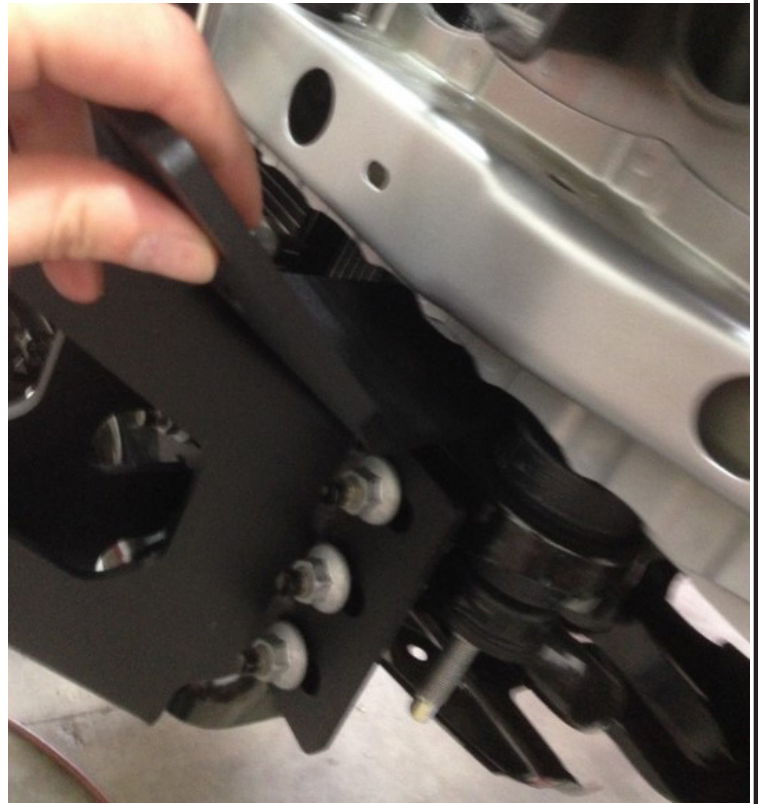

Figure 10

11. On each side, hang side support bracket A4 and A7 with long 1/2" bolt B15.

12. **Important!** Use three 1/2" Narrow Washer (B9), under the head of each long 1/2" bolt to prevent contact of threads with radiator housing.

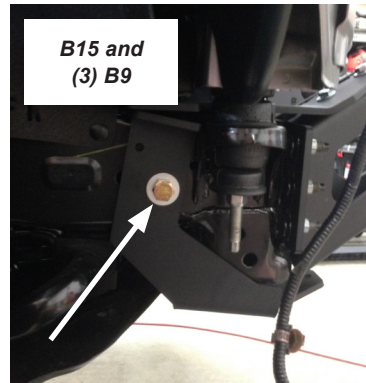

Figure 14

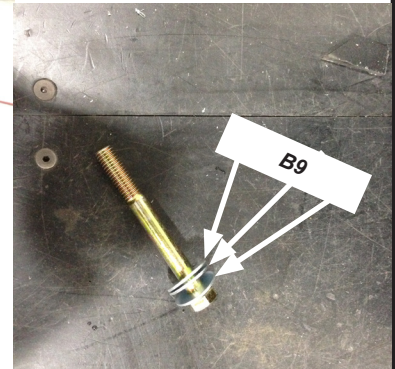

Figure 15

13. Lightly fasten side brackets with washer B9, lock washer B6, and nut B1.

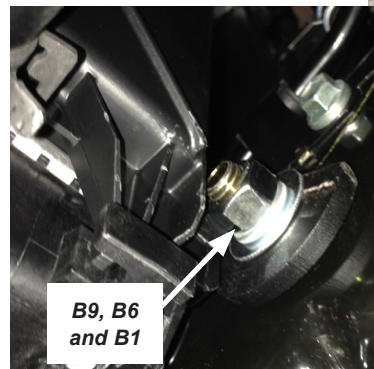

Figure 16

14. Loosely install 3/8" bolt B7, two washers B11, lock washer B3, and nut B2 to connect side bracket and top bracket to frame support. Repeat for other side.

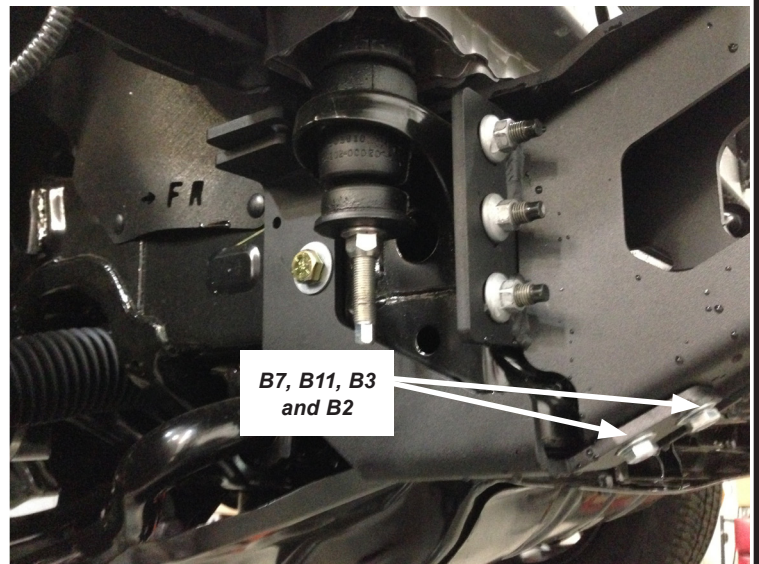

Figure 17a

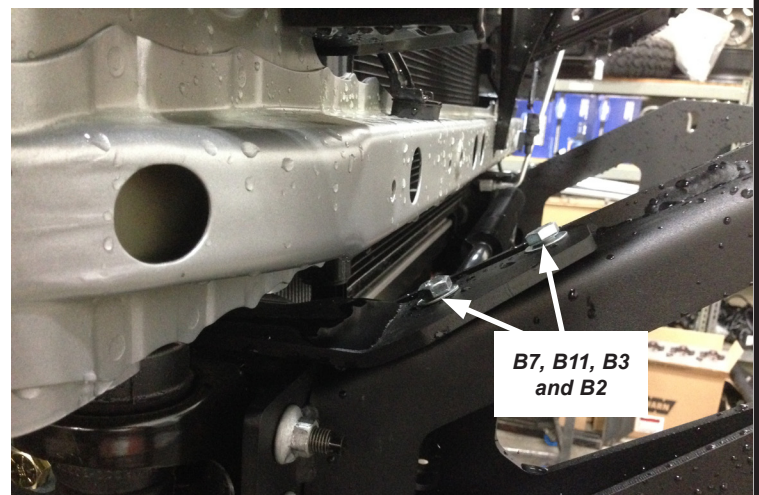

Figure 17b

15. Using the factory hardware, reinstall tow hooks.
16. Loosely install 3/8" bolt B7, two washers B11, lock washer B3 and nut B2 to connect side bracket to top bracket. Repeat for other side.

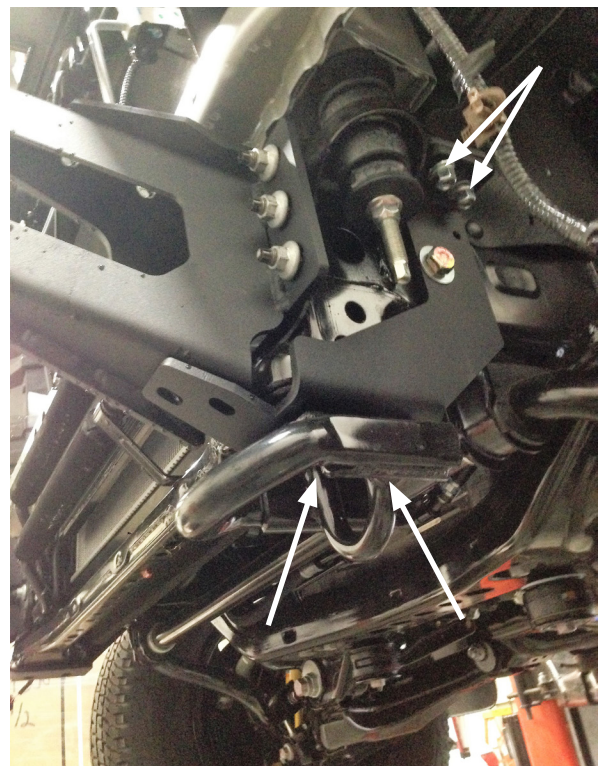

Figure 18

17. Tighten hardware in the following sequence:

- a) Frame bracket to frame flange.
- b) Side support to frame bracket.
- c) Tow hook to frame
- d) All other hardware.

18. Torque fasteners to final value and repeat on other side.



Figure 19a



Figure 19b



Figure 19c

19. Measure from the outside to outside of the inner bumper ribs.



Figure 20

20. Measure from inside to inside of frame brackets.

NOTE: You will want the bumper to just slide over the brackets with out being too tight. To make up for any gap, use spacers B16 and B17 to fill remaining space. Spacers can also be used to adjust bumper position left to right.



Figure 21

21. This is a good time to zip tie your fog lamp harnesses to any convenient place so it will not be in the way. Cover the end with electrical tape so dirt and debris does not enter plug.



Figure 22

CAUTION

- Always use assistance when moving or lifting heavy parts.

NOTE: If installing a Baja Bar to bumper, do so before placing bumper on frame brackets.

22. With assistance, slide the bumper over the frame brackets and secure with one 1/2" bolt (B10 or B13 - see note), two washers (B9), one lock washer (B6) and one nut (B1) in each of the four locations.

NOTE: Two lengths of 1/2" bolts (B10 and B13) are included. If using 1/4" or less of spacer, use the shorter hardware. Additional spacers will require the longer bolts.

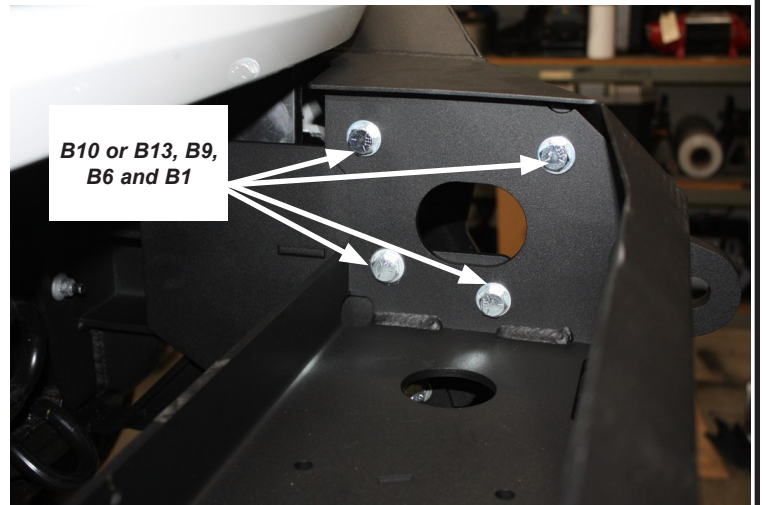

Figure 23

23. Under the winch tray, install one 7/16" bolt B12, two washers B8, one lock washer B4 and one nut B5, in each of the lower bolt hole locations.

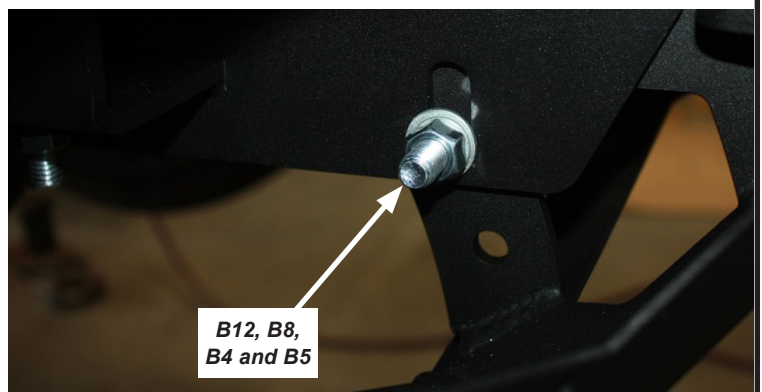

Figure 24

24. Now that all the hardware is installed:

- a) Check to make sure that there isn't too much space between the frame brackets and the bumper.
- b) Make sure the bumper is centered from side to side on the front fenders. Bumper may be adjusted up and down, in and out by loosening hardware on one or both sides. To adjust bumper left to right, add or remove spacers between brackets and bumper ribs.
- c) Once satisfied with alignment, torque all hardware to suggested values. **NOTE: Always make adjustments with assistance.**

25. From under and behind bumper, hold light bracket (A9 and A10) in place, line up light bezel (A11 and A12) through front bumper light port to bracket. Secure pieces together with ten stainless screws (B14). Review exploded view on page 3.

NOTE: If the vehicle is equipped with sensors, sensor holes are provided in the end sections of the bumper that will fit the factory carriages.

26. Remove the sensors from the factory bumper and install in new bumper's sensor holes.

27. If vehicle is not equipped with sensors, sensor hole plugs (B19) are provided to plug unused holes. **Trimming may be required for fit. Be sure to only trim from the skirt of the plug and leave locking tabs intact. RTV sealant can be used on the backside of the plug to ensure they stay in place.**

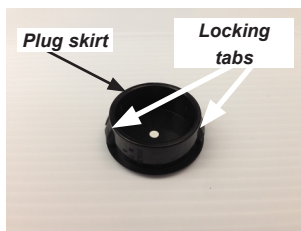

28. If not installing optional ascent bar accessories, plug unused holes with provided hole plugs (B20). Refer to exploded view.

29. If installing a winch, do so now. Refer to your winch instructions for installation details.

30. If skid plate was removed, reinstall now.

Installation is now COMPLETE!



Figure 25



Figure 26

MAINTENANCE / CARE

1. Inspect all parts on the winch, winch mount, and related hardware prior to each use. Replace all hardware that appears rusted or deformed.
2. Inspect all nuts and bolts on the winch, winch mount, and related hardware prior to each use. Tighten all nuts that appear to be loose. Stripped, fractured, or bent bolts or nuts need to be replaced.
3. Check all cables prior to use. Replace cables that look worn or frayed.
4. Check all moving or rotating parts. Remove debris that may inhibit the part from moving freely.

CARELESS INSTALLATION AND OPERATION CAN RESULT IN SERIOUS INJURY OR EQUIPMENT DAMAGE. READ AND UNDERSTAND ALL SAFETY PRECAUTIONS AND OPERATING INSTRUCTIONS BEFORE INSTALLING AND OPERATING THIS PRODUCT.

