

# INSTALLATION MANUAL

PRODUCT: REAR BUMPER  
MODEL: JEEP WRANGLER JL (2018-)  
PART NO: 2D.2709.1-NL  
2D.2723.1-NL



## CAUTION!

To reduce the risk of serious injury or damage, please read and understand all instructions and procedures before attempting to install or use this product.  
Safety glasses must be worn at all times during installation or maintenance of this product.  
Ensure all mounting bolts are tensioned after 250 miles and periodically thereafter.

## NOTICE

Whilst the bumper adds additional protection to your vehicle, precautionary measures still need to be taken to avoid damage.  
Always drive to the conditions and your surroundings.

# REAR BUMPER



**Part Number:** 2D.2723.1-NL (FULL WIDTH)  
**Suited to vehicle:** JEEP WRANGLER JL 2018-  
**Material:** Aluminum/Steel  
**Dimensions:** 1962x489x473 mm  
77.2x19.2x18.6 inch  
**Weight:** 43 kg / 97.8 pound



**Part Number:** 2D.2709.1-NL (STUBBY)  
**Suited to vehicle:** JEEP WRANGLER JL 2018-  
**Material:** Aluminum/Steel  
**Dimensions:** 1684x401x336 mm  
66.3x15.8x13.2 inch  
**Weight:** 40 kg / 80.2 pound

## SAFETY NOTICE

- \*The Bumper is designed to complement the use and design of the specified vehicle under conditions specified by the vehicle manufacturer.
- \* While driving the vehicle at any speed, collision with any other vehicle, animal or object must always be avoided.
- \* Following any collision with any other vehicle, animal or object, Bumper and the vehicle must be inspected by a specialized or suitably qualified vehicle repairer for possible damage to the components and assemblies in order to confirm suitability for further use of the vehicle.
- \* It is strongly recommended that you do not operate a vehicle with a damaged bumper or its components. In the case of damage, please contact the nearest Rival authorised stock list.
- \* The operation of a vehicle where the bumper is not properly attached and fastened to the vehicle, or where the bumper has been damaged, is extremely dangerous and must be avoided at all cost.
- \* It is recommended that you carry out regular inspections of all the bumper elements such as all bolts, wires, connectors.

## INSTALLATION NOTICE

- \* The Bumper must be mounted and affixed to the vehicle according to the installation manual provided by an authorized Rival dealer or Motor dealer or by a special vehicle repairer or fitment center.
- \* Estimated time for installation: 2 hours.
- \* Personal safety during the installation process must be adhered to at all times and the use of personal safety equipment is highly recommended.
- \* Do not install this bumper on vehicle models other than those allowed in this manual.
- \* Check state and local highway safety laws regarding permitted bumper types and heights.

## REQUIRED TOOLS

- \* Basic tool kit
- \* Torque wrench
- \* Crosspoint and flat head screwdriver

## TORQUE SETTING

\* M6 - 9 Nm (6.6 lb/ft), \* M10 - 30 Nm (22.1 lb/ft), \* M12 - 77 Nm (56.8 lb/ft), \* M14 - 123 Nm (90.7 lb/ft).

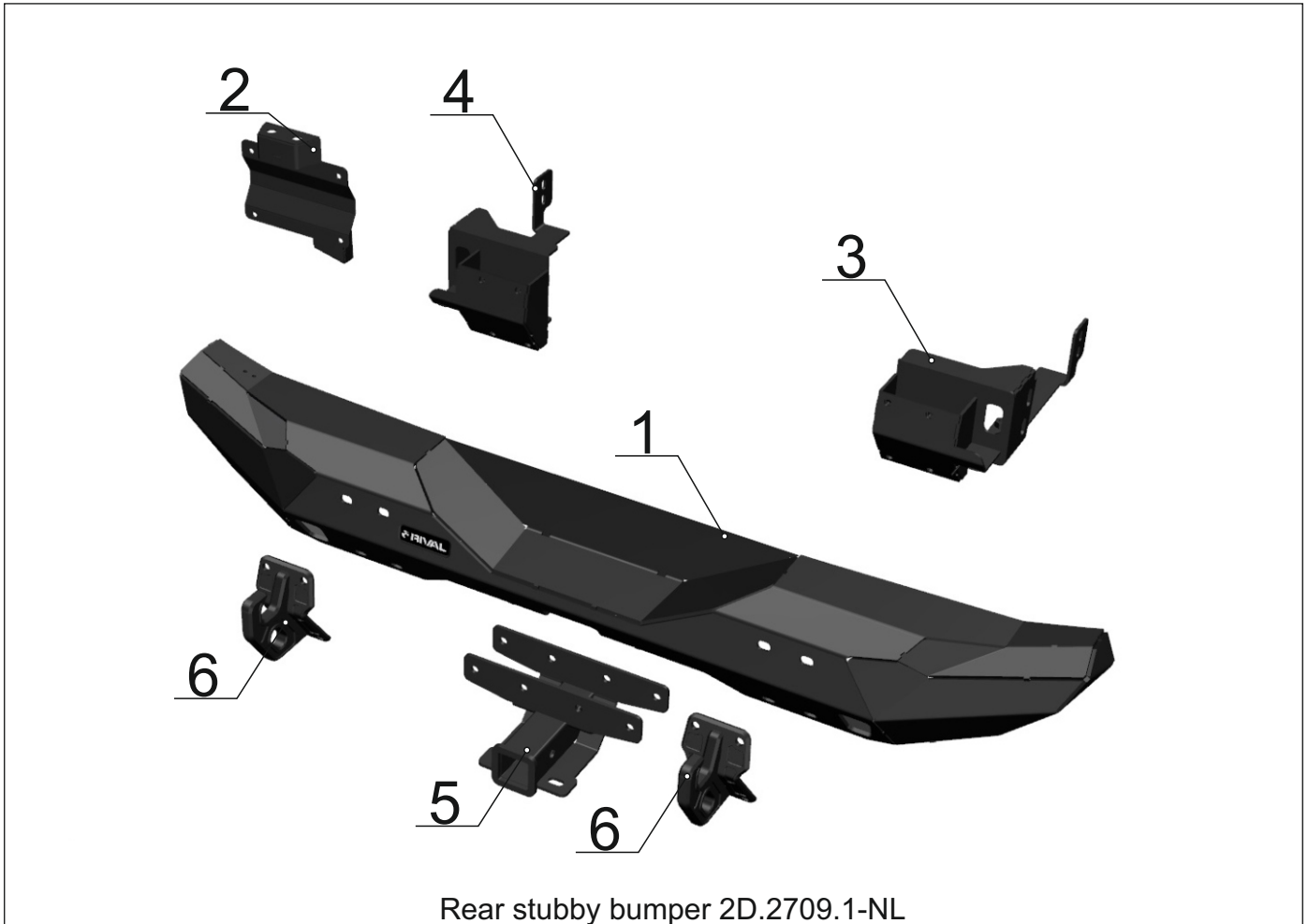

Rear stubby bumper 2D.2709.1-NL

- 1. Aluminum bumper body ..... Qty 1
- 2. License plate bracket ..... Qty 1
- 3. Right bracket..... Qty 1
- 4. Left bracket ..... Qty 1
- 5. Tow bar square..... Qty 1
- 6. Tow hook..... Qty 2

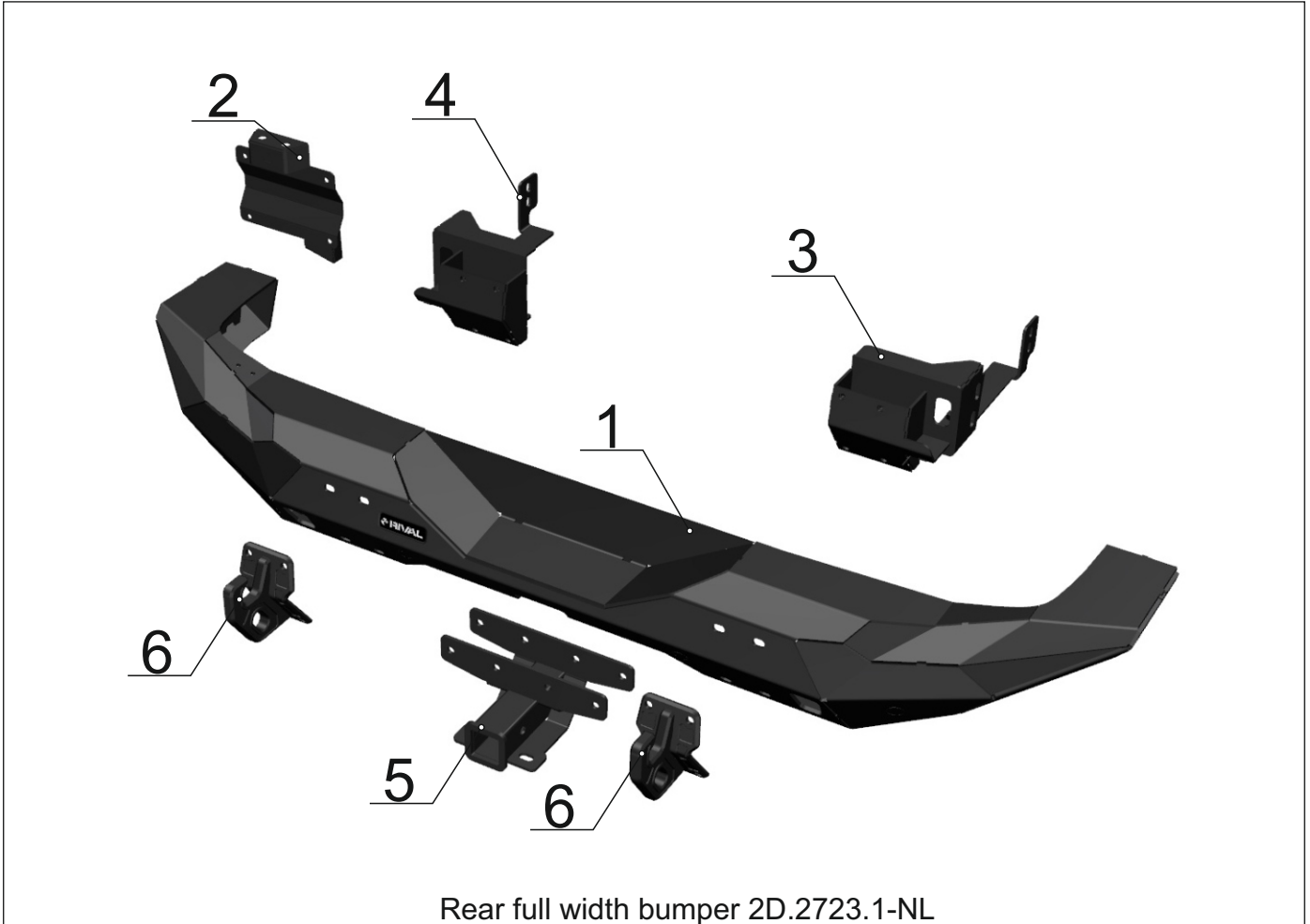

Rear full width bumper 2D.2723.1-NL

- 1. Aluminum bumper body ..... Qty 1
- 2. License plate bracket ..... Qty 1
- 3. Right bracket..... Qty 1
- 4. Left bracket ..... Qty 1
- 5. Tow bar square..... Qty 1
- 6. Tow hook..... Qty 2

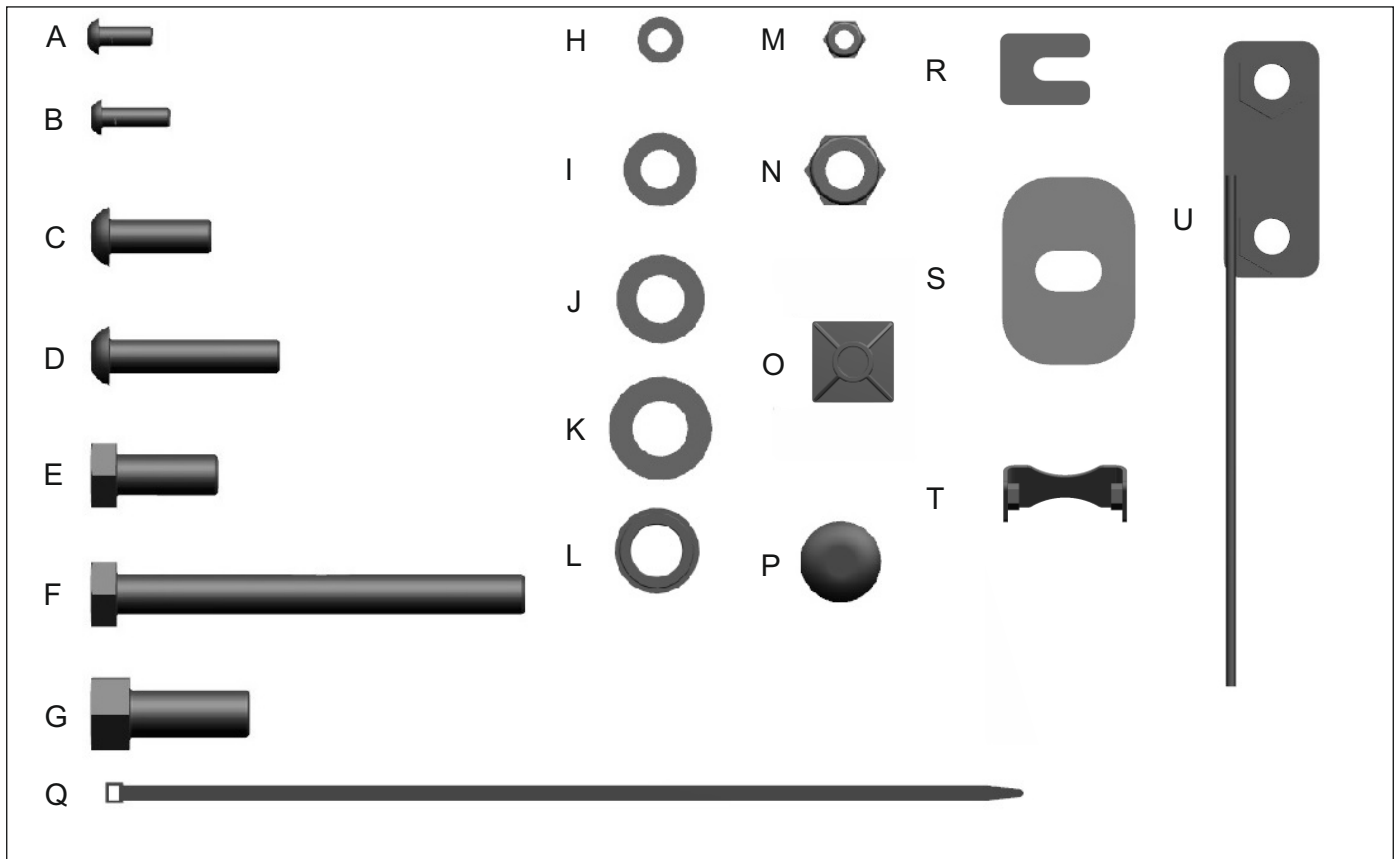

## 2D.2709.1-NL / 2D.2723.1-NL

A.	Screw M 6x16.....	Qty 8
B.	Screw M 6x20.....	Qty 2
C.	Screw M10x30.....	Qty 8
D.	Screw M10x50.....	Qty 2
E.	Bolt M12x30.....	Qty 3
F.	Bolt M12x120.....	Qty 4
G.	Bolt M14x35.....	Qty 4
H.	Washer 6.....	Qty 12
I.	Washer 10.....	Qty 10
J.	Washer 12.....	Qty 10
K.	Washer 14.....	Qty 4
L.	Parking sensor washer.....	Qty 4
M.	Nut M6.....	Qty 2
N.	Nut M 12.....	Qty 4
O.	Cable clips.....	Qty 5
P.	Plastic plug.....	Qty 4
Q.	Cable tie.....	Qty 4
R.	Spacer plate 2mm.....	Qty 4
S.	Spacer plate.....	Qty 6
T.	Parking sensor holding bracket .....	Qty 4
U.	Insert bracket M12.....	Qty 1

**Notice: the procedure of removing stock bumper can vary based on its type.**

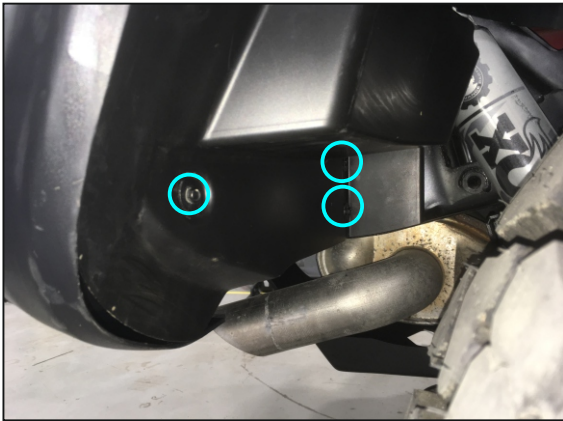

1. Unscrew 3 bolts from OE mud flap (on each side). Uninstall mud flaps.



2. Disconnect license plate lights on the left side of the vehicle.



3. Unscrew bumper's fitting bottom bolts.



4. Unscrew bumper's 2 fitting bolts from the rear beam.

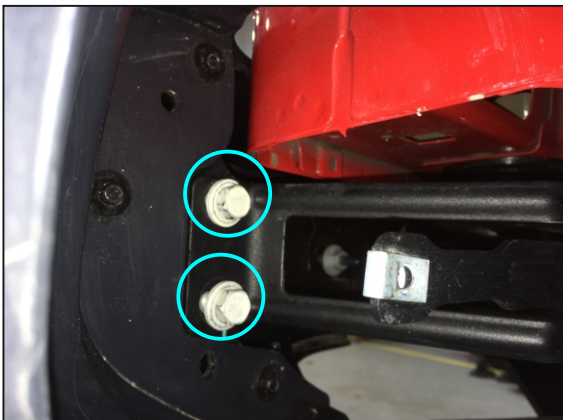

5. Unscrew bumper's 2 fitting bolts on the left and right side of the vehicle.

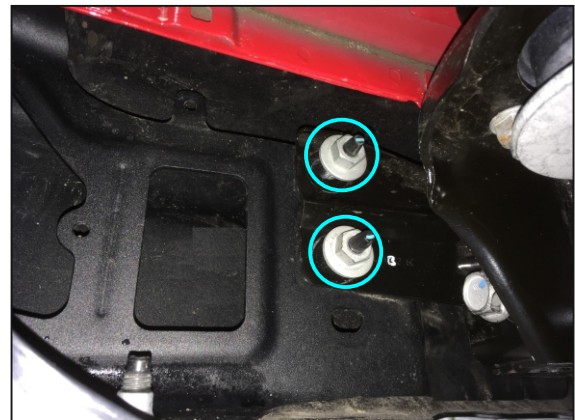

6. Unscrew bumper's 2 fitting nuts on the left and right side, close to body mount kit rear. Uninstall OE bumper.

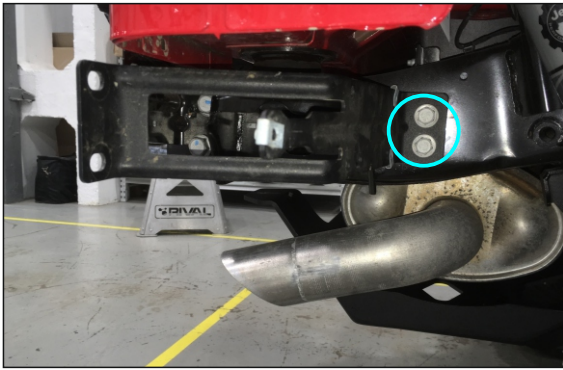

7. Unscrew side bracket's 2 fitting bolts on the left and right side.



8. Unscrew bumper bracket's 2 fitting bolts on the right side of the vehicle.



9. Unscrew OE tow hook's 4 fitting bolts on the left side of the vehicle. Set the tow hook aside as no further needed.



10. Install right bracket (pos. 3) on the vehicle frame, put insert bracket M12 (pos.U) onto the frame through the bracket hole. Attach the bracket to the Insert bracket M12(pos. U) using bolts M12x30 (pos.E) and washers 12 (pos.J). **Do not tighten yet.**

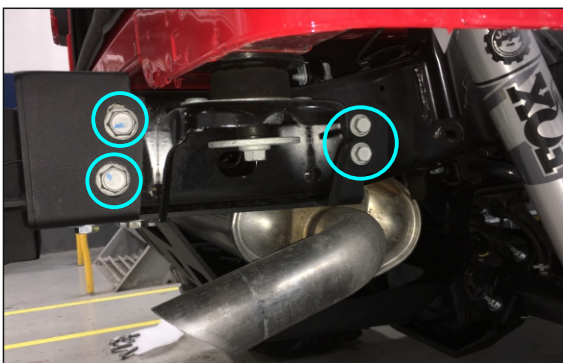

11. Attach right bracket (pos.3) using OE bolts M14 and M10. Torque hardware to \*M14 - 123 Nm (90.7 lb/ft) and \*M10 - 30 Nm (22.1 b/ft).

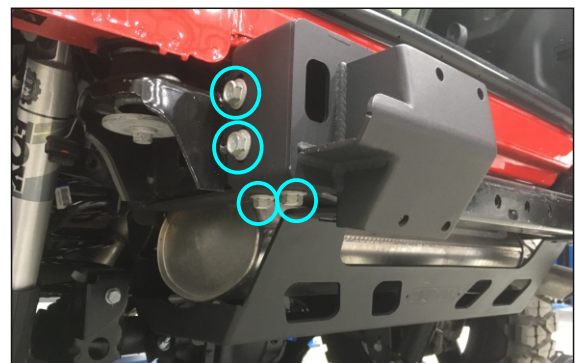

12. Fix left bracket (pos.4) using bolts M14x35 (pos. G) and washers 14 (pos.K). Torque hardware to \*M14 - 123 Nm (90.7 lb/ft).

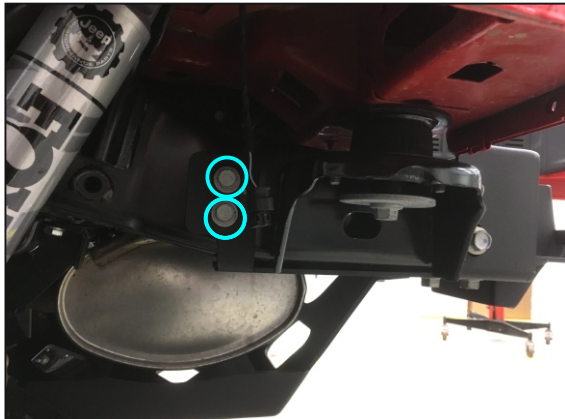

13. Attach back end of the bracket (pos.4) using OE bolts M10. Torque hardware to \* M10 - 30 Nm (22.1 lb/ft).



14. Install tow bar square (pos.5) using bolts M12x120 (pos.F), washer 12 (pos.J) and nuts M12 (pos.N). Torque hardware to \* M12 - 77 Nm (56.8 lb/ft) .

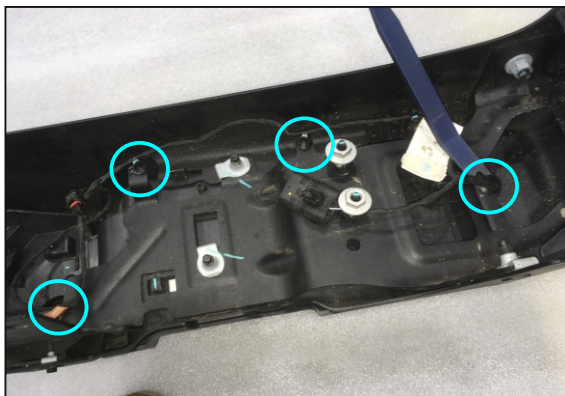

15. Uninstall license plate light fittings in the OE bumper.



16. Remove the license plate lights. Disconnect license plate lights connector.



17. Install license plate bracket (pos.2) using screws M6x20 (pos.B), washers 6 (pos.H) and nuts M6 (pos.M). Torque hardware to \* M6 - 9 Nm ( 6.6lb/ft).



18. Connect wiring of the license plate bracket lights through the license plate hole.





19. Fix license plate lights using OE fitting fit. Be careful, do not damage

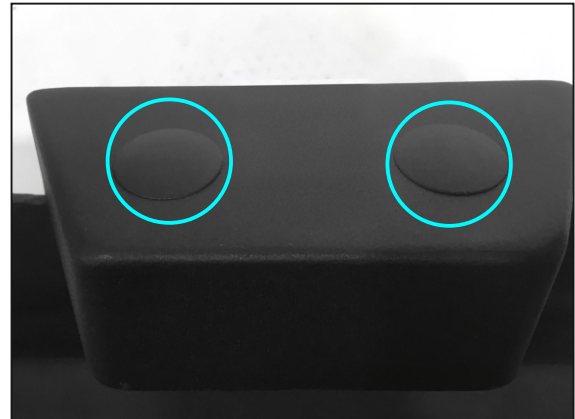

20. Mount plastic plugs (pos. P) onto the license plate bracket holes.

**Installation of parking sensors.  
Notice: Steps 21-32 are for vehicles with stock sensors.**

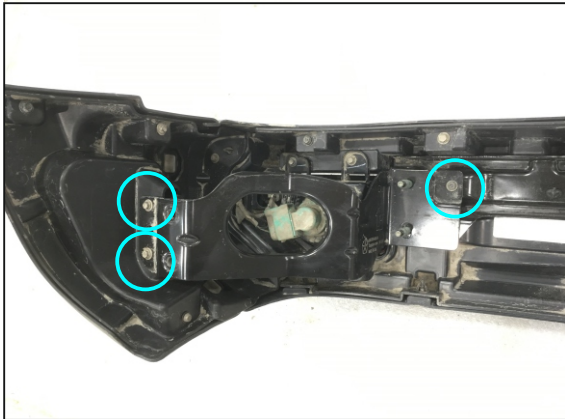

21. Unscrew 3 screws that hold bumper bracket on the left and right side.

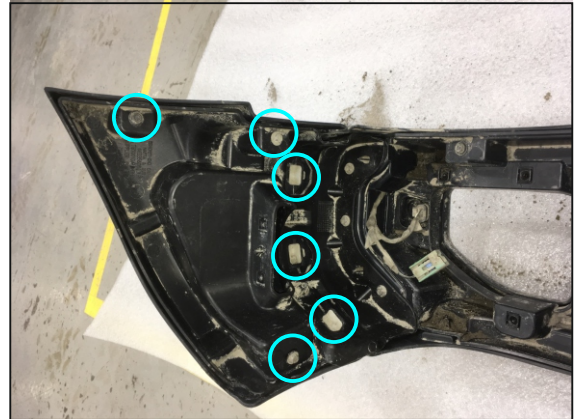

22. Unscrew 3 screws and carefully snap off 3 plugs that hold outer sidewall bumper bracket on the left and right side.

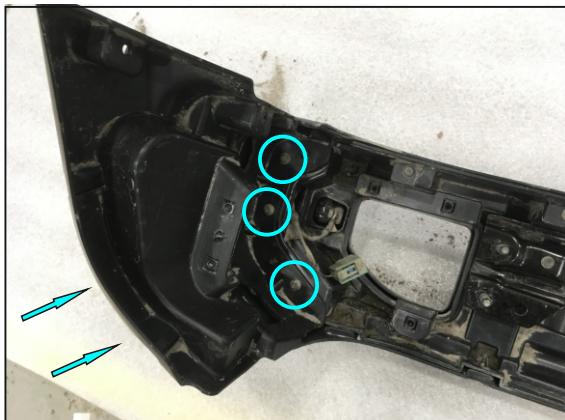

23. Unscrew 3 screws that hold inner sidewall bumper bracket on the left and right side from the inside and 2 screws on the outside.

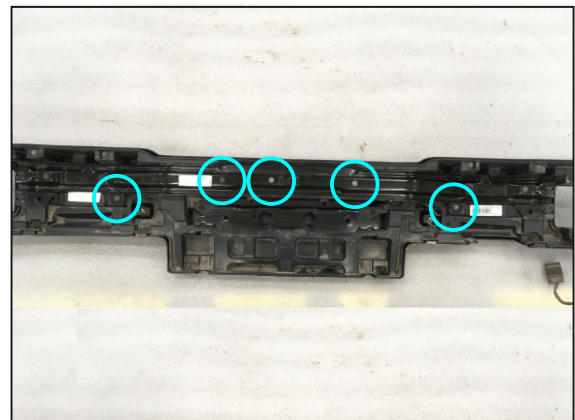

24. Unscrew 5 screws that hold bumper reinforcement.

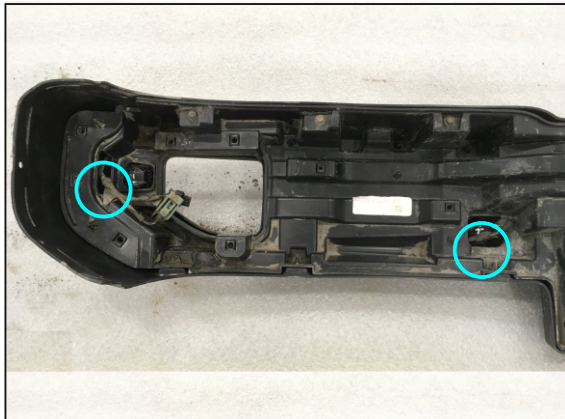

25. Disconnect 4 parking sensors connectors.

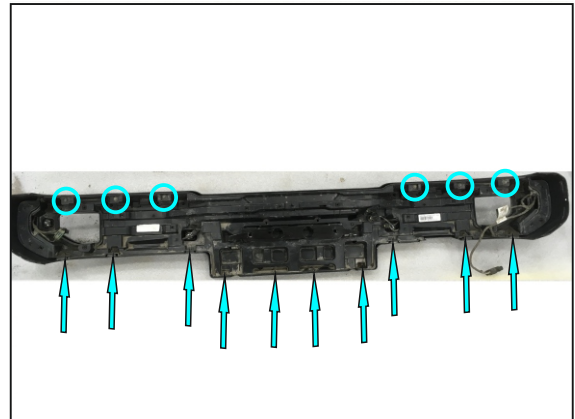

26. Unscrew 6 screws at the top and 10 screws at the bottom that hold plastic bumper reinforcement.

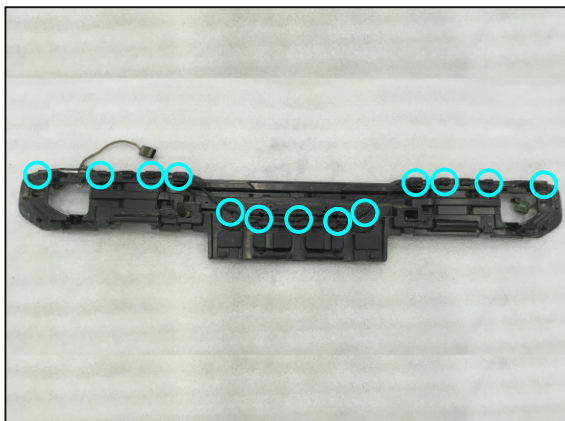

27. Disconnect parking sensors wiring from plastic bumper reinforcement.

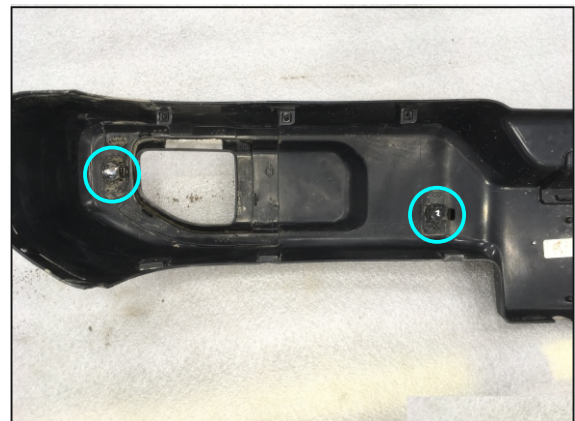

28. Take parking sensors off the bumper.

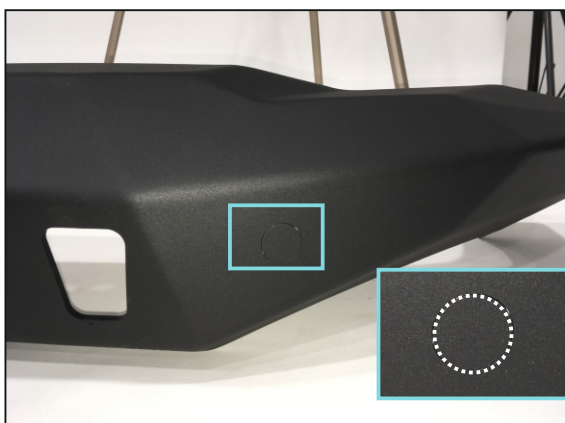

29. Hammer out 4 parking sensors plugs from the bumper (For the vehicle with parking sensors).



30. Install parking sensor washers (pos. L) into the holes that you hammered out.



31. Install parking sensors into the parking sensors washers and attach it using parking sensor holding brackets (pos. T). Attach parking sensor holding brackets using screws M6x16 (pos. A) and washers 6 (pos. H). Torque hardware to \* M6 - 9 Nm (6.6 lb/ft) (make sure that parking sensors attach well).



32. Connect wiring with parking sensors. Attach wiring on the bumper using cable clips (pos. O) and cable tie (pos. Q).

## Aluminum bumper body installation.



33. Install aluminum bumper body (pos.1) onto the brackets. Adjust the bumper until you have an equal gap between vehicle body and the bumper on both sides. Connect license plate lights connector and parking sensors wiring.



34. Install tow hooks (pos. 6) onto the bumper. Fix them using screws M10x30 (pos. C) and washers 10 (pos. I). Install OE tow bar socket on spacer plate (pos. S), fix it using screws M10x50 (pos. D). Torque hardware to \* M10 - 30 Nm (22.1 lb/ft).

**Before operating a vehicle fitted with a RIVAL Bumper 2D.2709.1-NL, 2D.2723.1-NL:**

- make sure all fittings are torqued to proper specifications
- check all electrical wiring attached to lights



**Thank you for your choice!**

**Sincerely,  
RIVAL 4x4 Team**