



### Installation Instructions

BR20 Rear Bumper Replacement Part Number 28169T

Chevrolet Silverado 2500HD & 3500HD 2/4WD

### Parts List

Item	Qty.	Part #	Description
1	1	28169T0AA	Bumper Replacement Shell
2	1	28169T0DA-D	Driver Side Frame Bracket
3	1	28169T0DA-P	Passenger Side Frame Bracket
4	2	28173T5AB	Flush Mount Light Pod Plate
5	1	28169T5GA	Sensor Bezel Plate (passenger inner)
6	1	28169T5GA	Sensor Bezel Plate (driver inner)
7	1	28169T5FA	Sensor Bezel Plate (passenger outer)
8	1	28169T5FA	Sensor Bezel Plate (driver outer)
9	1	28169T6HA	Trailer Plug Relocation Bracket
10	5		Round Plug

Item	Qty.	Description	Torque
11	2	LED License Plate Light	
12	8	1/2" x 1 1/2" Hex Bolt	65 ft. lbs.
13	16	1/2" Flat Washer	
14	8	1/2" Lock Washer	
15	8	1/2" Hex Nut	
16	2	M14 x 50mm Hex Bolt	88 ft. lbs.
17	4	M14 Flat Washer	
18	2	M14 Lock Washer	
19	2	M14 Hex Nut	
20	12	10-32 x 3/4" Button Head Bolt	30 in. lbs.
21	12	10-32 Nylon-Insert Lock Nut	

### ILLUSTRATION #1

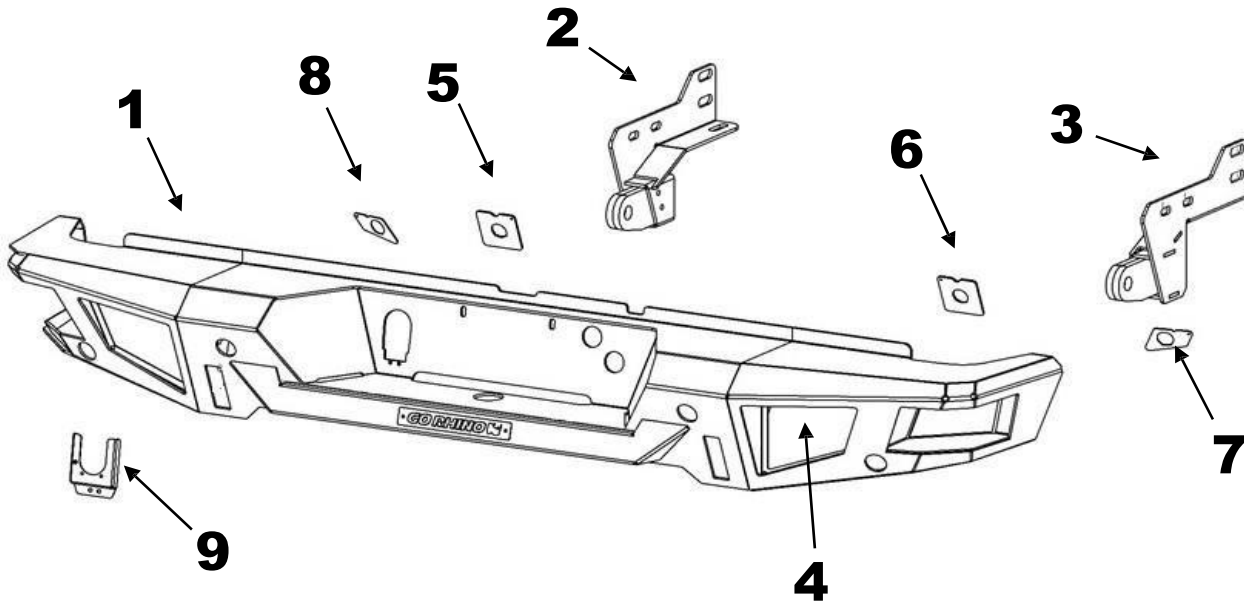

### Tool Required:

- 15mm, 21mm, 22mm, 3/8" & 3/4" Sockets
- 10mm, 15mm, 21mm, 22mm, 3/8" & 3/4" Wrenches
- Slotted Blade Screw Driver
- 1/8" Hex Key
- Ratchet, Ratchet Extensions & Swivel Joint Adapter
- 12V Circuit Tester

Approximate installation time: 2 hrs.

## IMPORTANT INSTALLATION NOTES AND SUGGESTIONS

Read the installation instructions completely and verify that all of the parts listed are accounted for. If you have defective, missing or damaged parts or need assistance, please contact Go Rhino Products for fast, friendly customer service at: (888) 427-4466 or email: sales@gorhino.com

Verify that the tailgate does not come in contact with the bumper replacement when opening and in the lowered position, before final tightening all nuts and bolts. If necessary, loosen the nuts and bolts to adjust the bumper replacement.

If you are replacing a bumper with rear Park Assist, the sensor detection zone will be altered with use of this bumper replacement.

To maintain and care for this product keep it clean and do not use abrasive cleaners or polish waxes. Texture Painted Finish: Mild liquid detergent may be used. Polished Stainless & Semi-Gloss Painted Finishes: We recommend using only non-abrasive automotive wax such as pure carnauba to avoid scratches and rust.

### Factory Bumper Removal

**Step-1** Disconnect the vehicle battery or batteries.

**Step-2** Lower and remove the spare tire to access the bumper and vehicle wiring.

**Step-3** Disconnect the vehicle wiring harness for the trailer plug from the bumper, (Photo 1).

**Step-4** Disconnect the bumper wiring harness for the reverse proximity sensors and license plate lights from the vehicle wiring harness.

**Step-5** Remove the bolts (1) per side securing the bumper to the center of the receiver hitch using a 21mm socket and ratchet, (Photo 2).

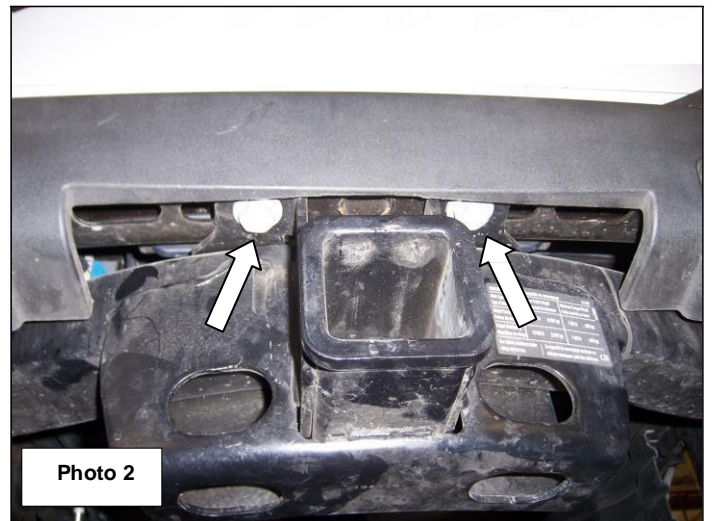
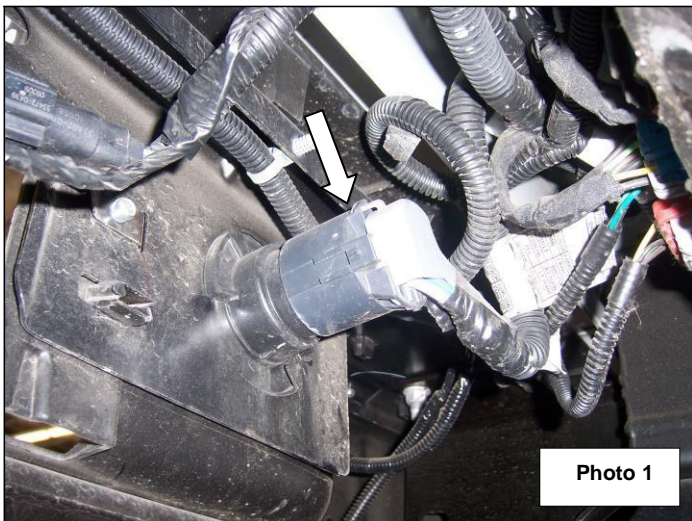

**Step-6** Remove the bolts (1) per side securing the bumper brackets and receiver hitch to the bottom of the frame using 21mm socket and ratchet, (Photo 3).

**Step-7** Remove the bolts (3) per side securing the bumper brackets to the inside of the frame using a 15mm, 21mm socket, and ratchet, (Photo 4). Remove the bumper by pulling upward and out from the vehicle.

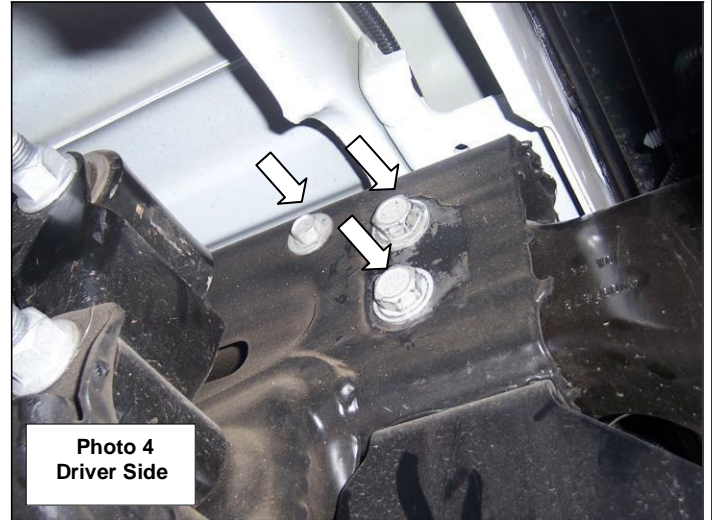

**Step-8** Remove the license plate, disconnect the license plate lights, and If equipped disconnect the backup sensors from the factory bumper wiring harness.

**Step-9** Remove the wiring harness from the factory bumper.

### BR20 Bumper Replacement Installation

**Note:** if your vehicle is not equipped with rear **Park Assist** install the supplied round plugs in the holes in the replacement bumper and proceed to Step 7.

**Step-1** If the vehicle is equipped with rear **Park Assist**, remove each sensor from the bezel by gently spreading the bezel tabs and pulling out on the back of the sensors. Note: Do not push on the front of the sensor as this may damage the sensor.

**Step 2** Remove the sensor bezels from the factory bumper by depressing the (4) tabs around the base and pushing the bezel out through the front of the bumper. Note: The sensors and bezels have to be positioned in the replacement bumper in the same location (inner and outer), (driver and passenger) as removed from the factory bumper.

**Step-3** Install the sensor bezels and sensors in the (inner and outer) bezel plates, (Photo 1 & 2). Line up the protrusions on the bezel with the profile in the bezel plate; push the bezel through the profile in the plate until the tabs around the base lock in position, then install the sensor in the bezel. Note: The notch in the bezel plate designates the top.

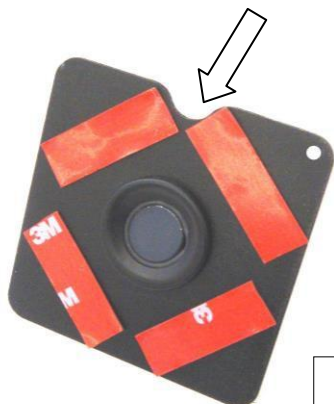

Photo 1  
Passenger  
Side Inner

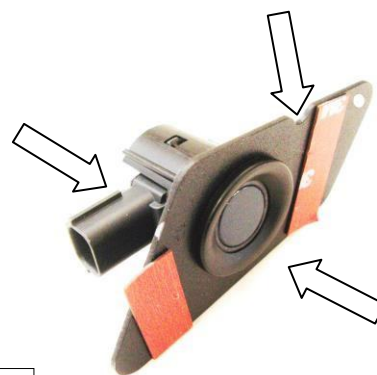

Photo 2  
Passenger  
Side Outer

**Step-4** Prepare the inside surface of the bumper shell where the bezel plates will be mounted with Isopropyl alcohol. A clean, dry surface is required in order for tape to stick properly.

**Step-5** Peel the backing off from the double sided tape to uncover the adhesive. From inside the bumper shell position each bezel, sensor and bezel plate assembly, making sure the sensor bezel is centered in the hole provided in the bumper shell, (Photo 3 & 4).

### BR20 Bumper Replacement Installation

**Step-6** Stick the assembly in place and apply firm pressure for about 30 seconds. The tape needs to bond with the mounting surface, and it needs pressure to do this. The bezel mounting plate will seem like it is stuck on, but continue pressing for at least 30 seconds. Note: At room temperature approximately 50% of ultimate bond strength will be achieved after 20 minutes, 90% after 24 hours and 100% after 72 hours.

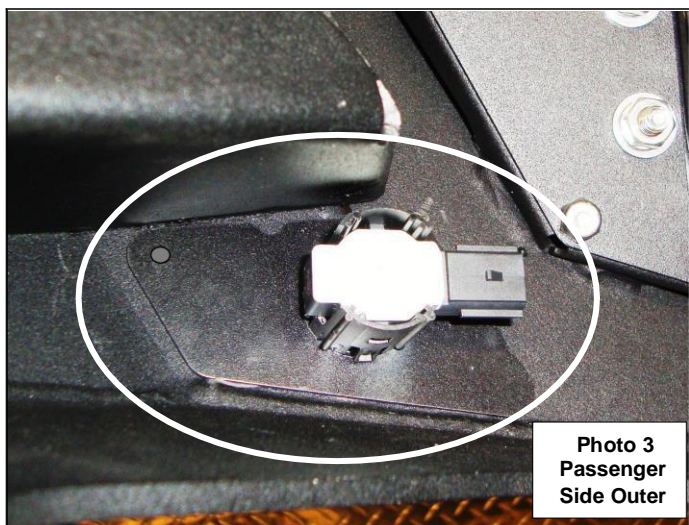

Photo 3  
Passenger  
Side Outer

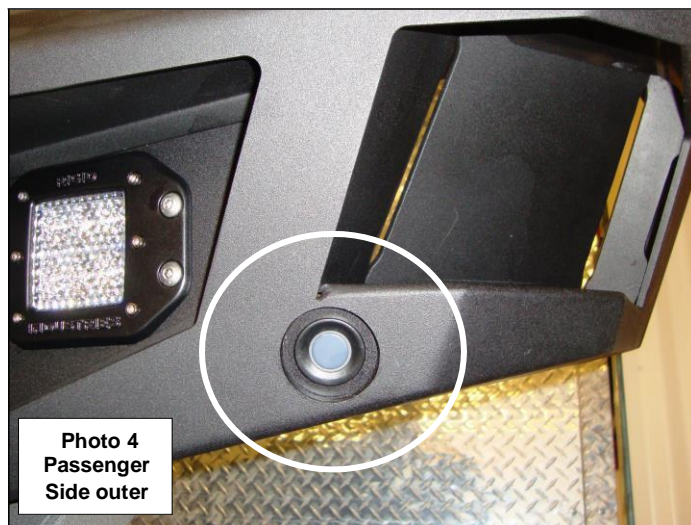
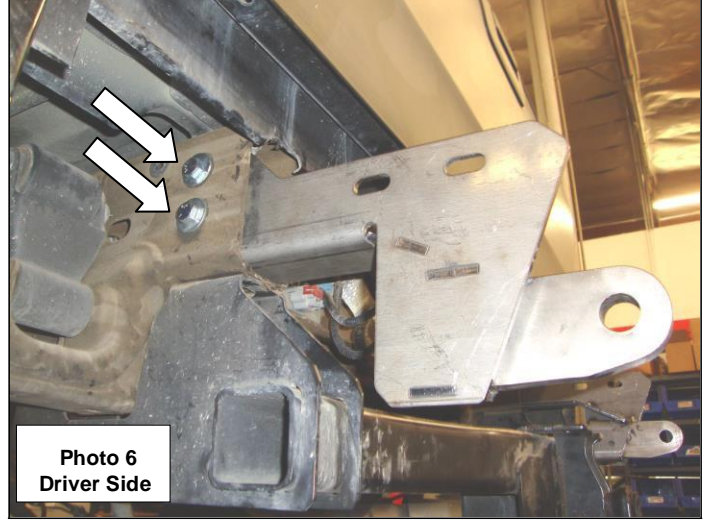
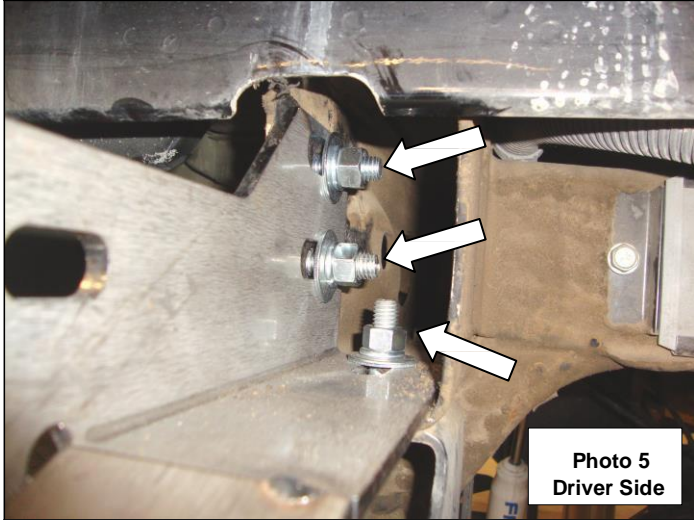

Photo 4  
Passenger  
Side outer

**Step-7** Position the driver side frame bracket inside the frame rail and secure the frame bracket and receiver hitch to the bottom of the frame using (1) M14 x 50mm hex bolt, (2) M14 flat washers, (1) M14 lock washer and (1) M14 hex nut. Secure the frame bracket to the side of the frame using (2) ½" x 1 ½" hex bolts, (4) ½" flat washers, (2) ½" lock washers and (2) ½" Hex nuts, (Photo 5 & 6). Adjust the frame bracket outward from the vehicle, then snug but do not tighten the nuts and bolts. Repeat to install the passenger side frame bracket.



### BR20 Bumper Replacement Installation

**Step-8** With assistance lift the bumper replacement up to the vehicle. Position the bumper brackets on the outside of the frame brackets, align the holes and secure bumper brackets to each frame bracket using (2) ½" x 1 ½" hex bolts, (4) ½" flat washers, (2) ½" lock washers and (2) ½" hex nuts, (Photo 7 & 8).

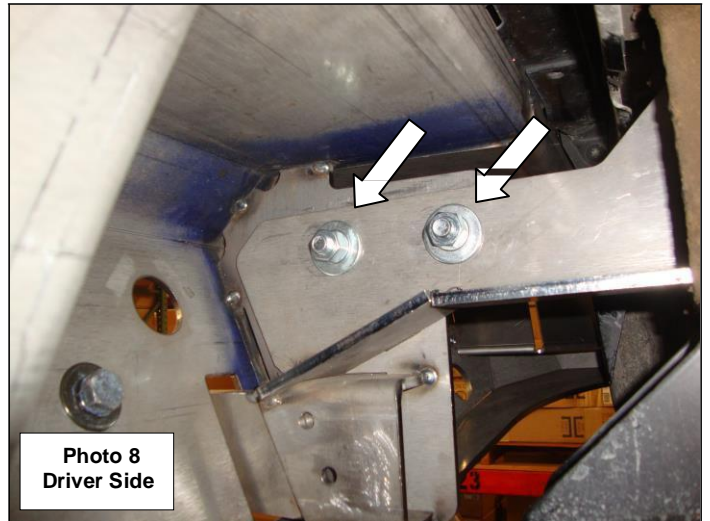
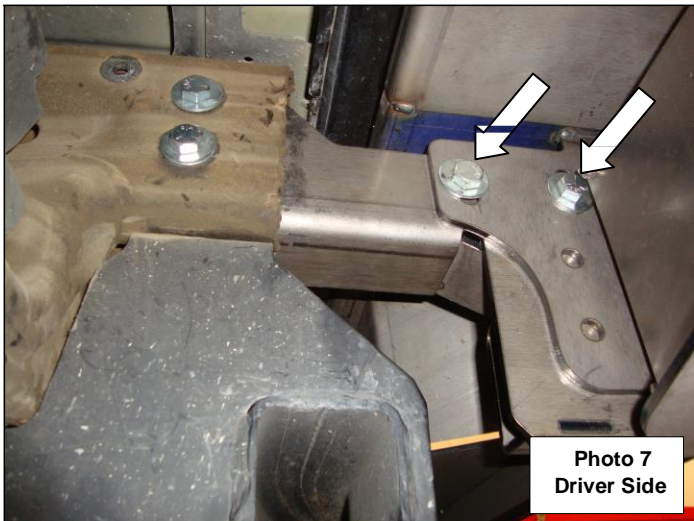

**Step-9** Align the bumper replacement with the vehicle, verify that the tailgate clears when lowered, and tighten all nuts and bolts, (Photo 9). If necessary, loosen the frame bracket / receiver hitch bolts to adjust the bumper replacement.

**Step-10** Secure (cable tie) the spare tire winch access tube to the frame (Photo 10) and use the supplied round plug to fill the unused access tube hole in the rear bumper replacement.

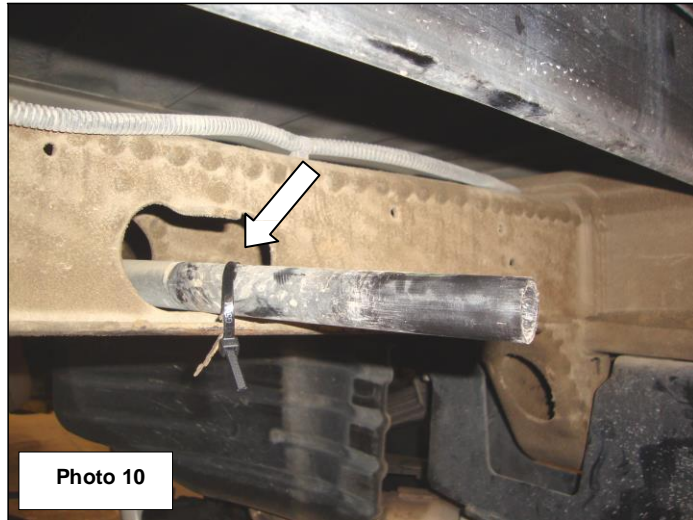

### BR20 Bumper Replacement Installation

**Step-11** Remove the trailer plug from the factory bumper.

**Step-12** Position the supplied relocation bracket between the trailer plug flanges, then slide the bracket up until the tab on the trailer plug flange locks into the hole in the bracket. Use the (2) smaller holes in the bracket as a guide and drill 3/16" holes through the trailer plug flange. Secure the trailer plug flange to the bracket using (2) 10-32 x 3/4" button head bolts and (2) 10-32 lock nuts, (Photo 11).

**Step-13** Attach the trailer plug and bracket assembly to the bumper replacement using (2) 10-32 x 3/4" button head bolts and (2) 10-32 lock nuts, (Photo 12). Reconnect the trailer plug to the wiring harness.

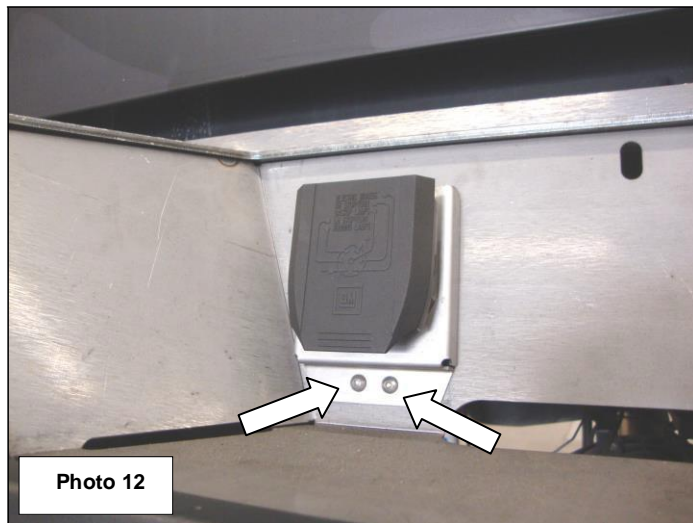
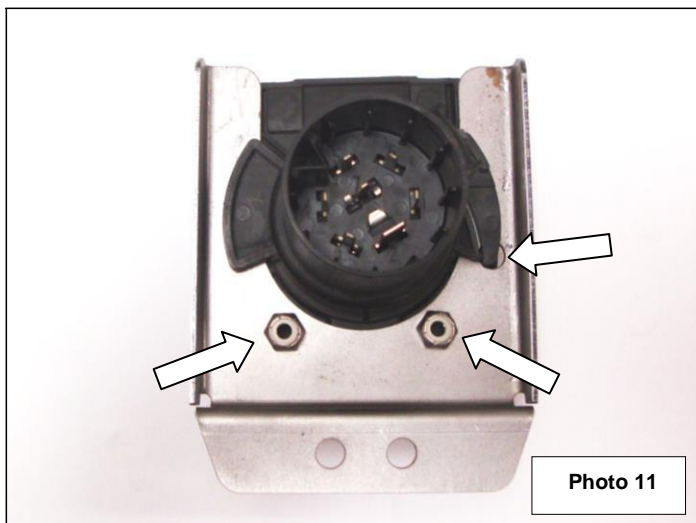

**Step-14** Reconnect the factory bumper wiring harness to the sensors and to the vehicle wiring harness.

**Step-15** Install the license plate using the supplied LED lights and fasteners to the bumper shell. Use a circuit tester to find the hot and ground from the factory license plate light wiring, and then splice the wires from the supplied lights.

**Step-16** Install the supplied flush mount light pods plates or optional light mounts to the bumper shell using (4) 10-32 x  $\frac{3}{4}$ " button head bolts and (4) 10-32 lock nuts.

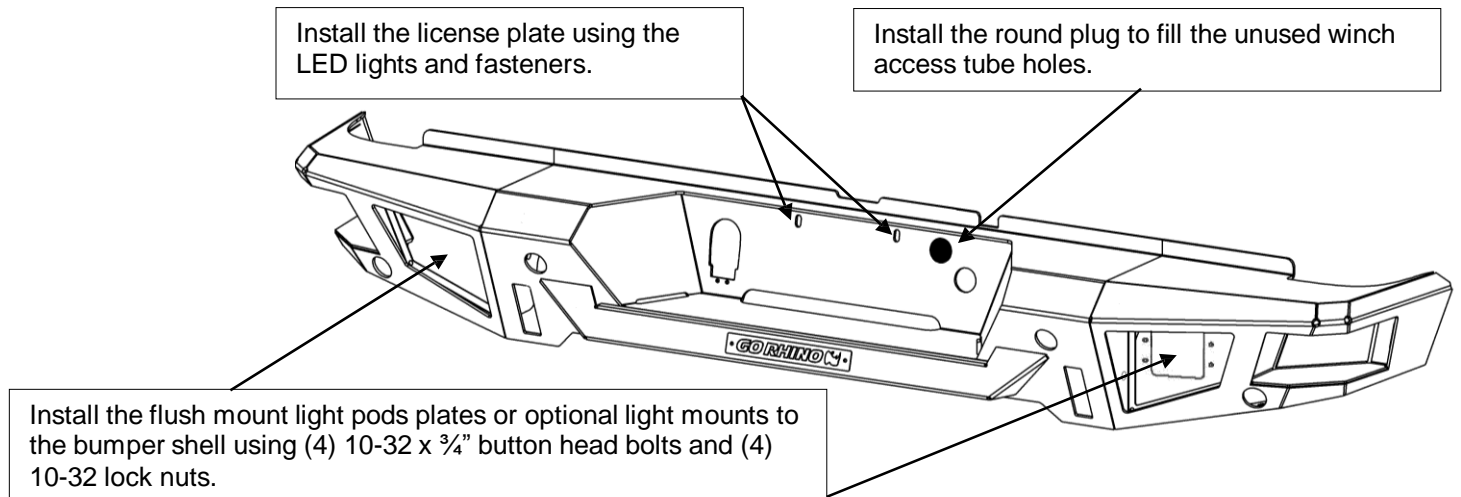

**Step-17** Remember to check and retighten all factory and supplied nuts and bolts periodically.