



**ASSEMBLY GUIDE  
GUIDE DE MONTAGE  
GUÍA DE MONTAJE**

**MEZZA**

# **LARGE PARKLETTE PLANTER**

## **GRAND PLANTEUR DE PARKLETTE**

## **GRAN PARKLETTE PLANTER**

**VT17716**

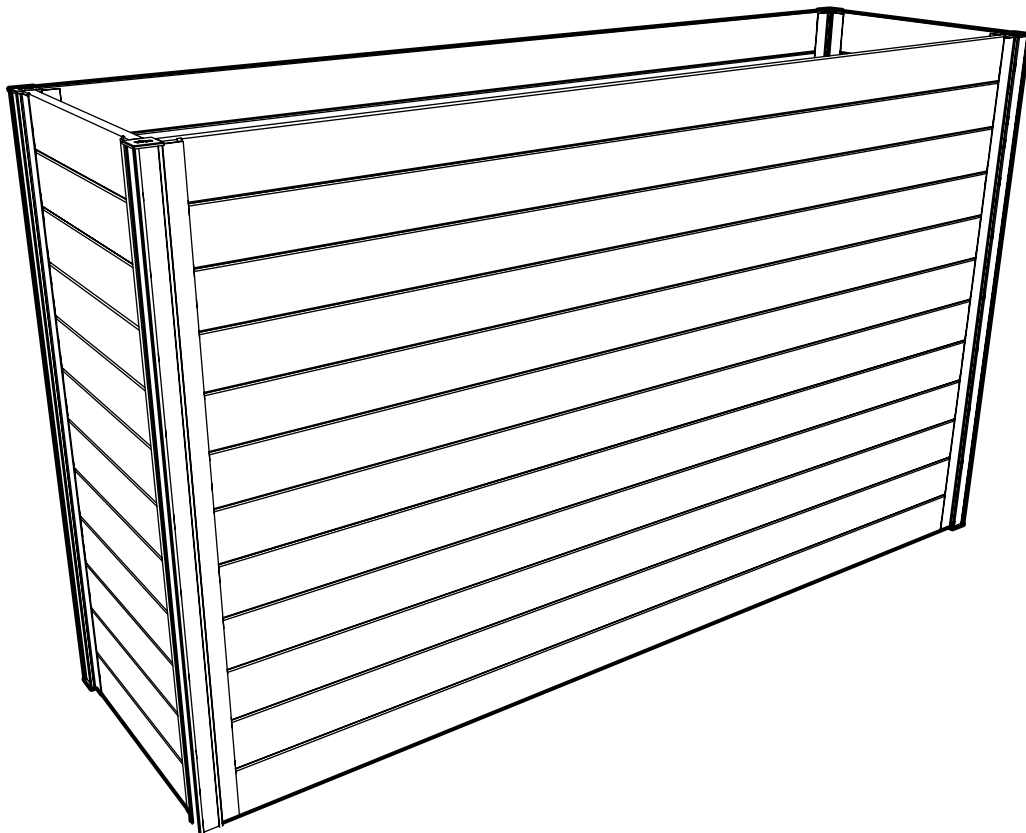

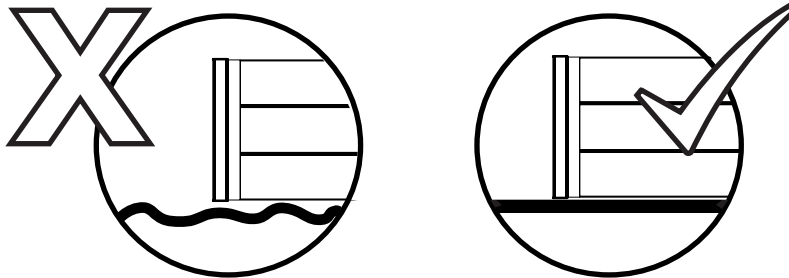
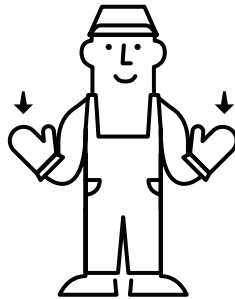
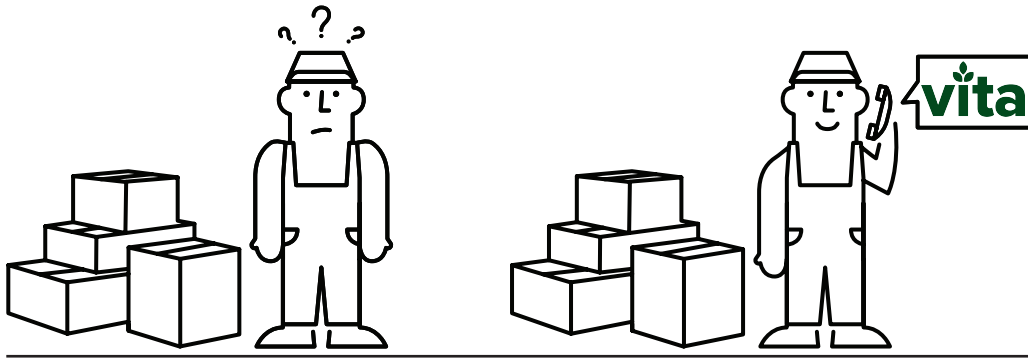

 1-800-282-9346



HELLO@WEAREVITA.COM



WWW.WEAREVITA.COM



8:00 AM - 5:00 PM EST



# PARTS LIST

# LISTE DES PIÈCES

# LISTA DE PARTES



**17050 - POST** - PUBLIER - EXPONER - 33" (83.8 CM) - **X4**

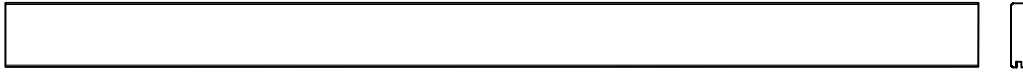

**17052**  
**TOP BOARD A** - CONSEIL SUPERIEUR A - TABLERO SUPERIOR A  
53 1/2" (135.9 CM) - **X2**



**17043**  
**TOP BOARD B** - CONSEIL SUPERIEUR B - TABLERO SUPERIOR B  
13 1/2" (34.3 CM) - **X2**



**17053**  
**STACKING BOARD C** - TABLEAU DE EMPILAGE C - PTABLERO DE APILAMIENTO C  
53 1/2" (135.9 CM) - **X20**

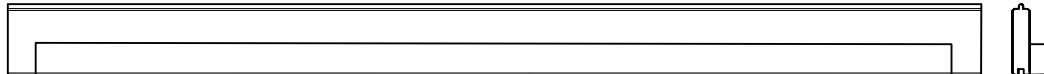

**17054**  
**FLOOR BRACE BOARD** - CONSEIL DE RENFORT DE PLANCHER - JUNTA DE SOPORTE DE PISO  
53 1/2" (135.9 CM) - **X2**



**17045**  
**STACKING BOARD D** - TABLEAU DE EMPILAGE D - PTABLERO DE APILAMIENTO D  
13 1/2" (34.3 CM) - **X22**

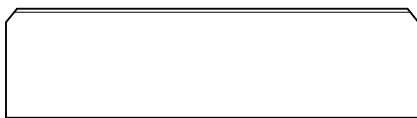

**17055**  
**FLOOR BOARD E** - PLANCHE D'ÉTAGE E - TABLERO DE PISO E  
14.21" (36.09 CM) - **X2**

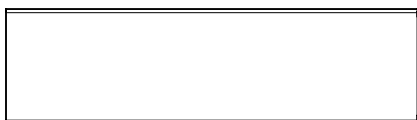

**17056**  
**FLOOR BOARD F** - PLANCHE D'ÉTAGE F - TABLERO DE PISO F  
14.21" (36.09 CM) - **X16**



**17020**  
**POST CAP** - ETE DE POTEAU - TAPON  
1 1/4" X 1 1/4" (3.2 CM x 3.2 CM) - **X8**

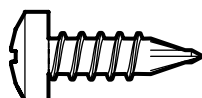

**20066**  
**SCREW** - VISSER - TORNILLO  
5/8IN (1.6CM) - **X8**

**PRODUCT DIMENSIONS DIMENSIONS DU PRODUIT DIMENSIONES DEL PRODUCTO**

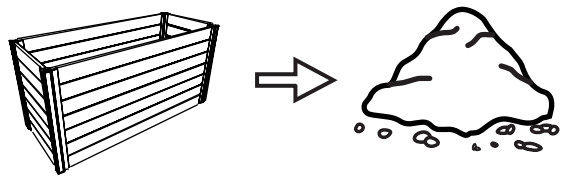
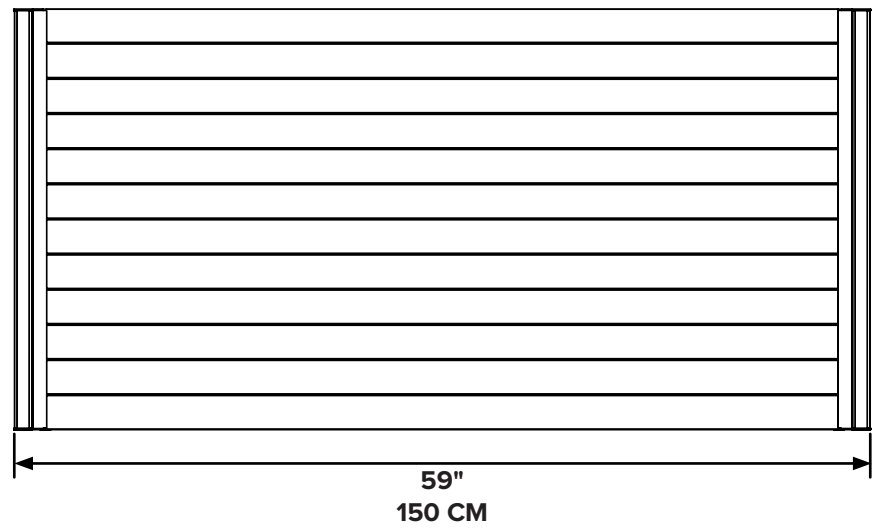
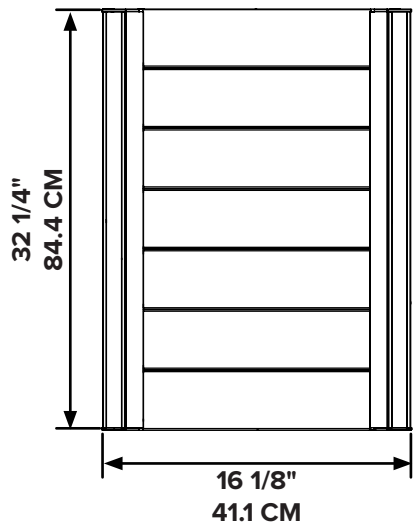
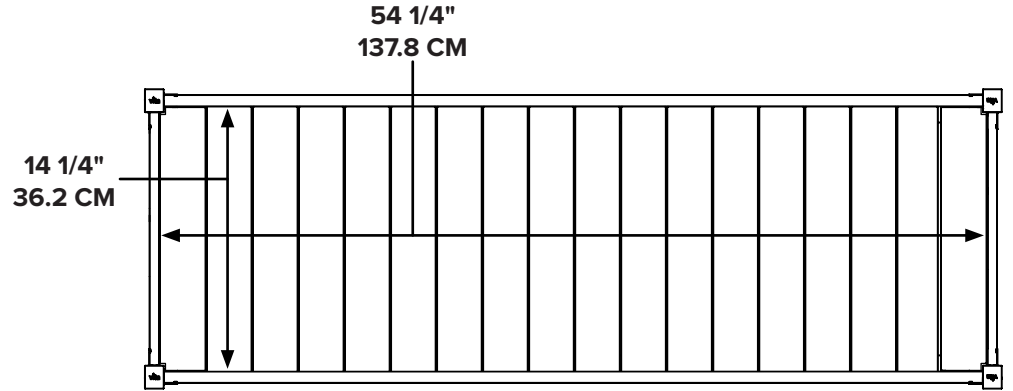

**CU M ----- 0.42**

**CU FT ----- 14.8**

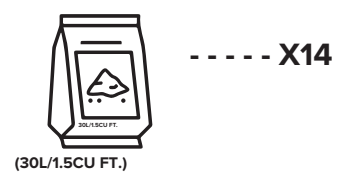

1

17050 - x4 

17020 - x4 



x4



2

17053 - x2 

17045 - x2 

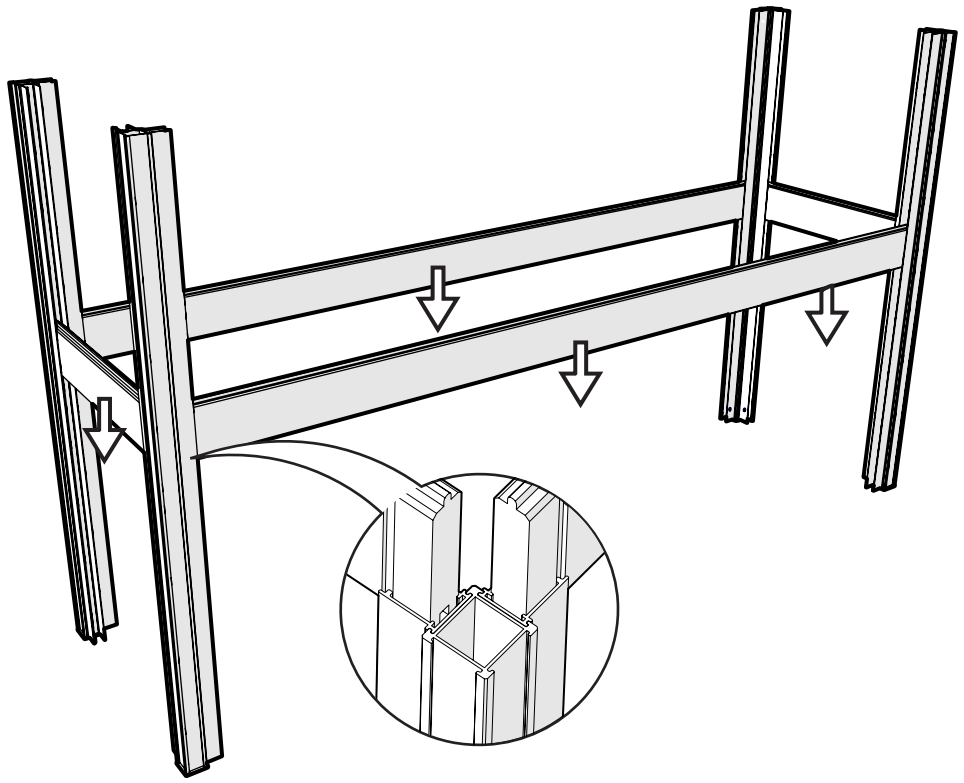

3

20066 - x8 

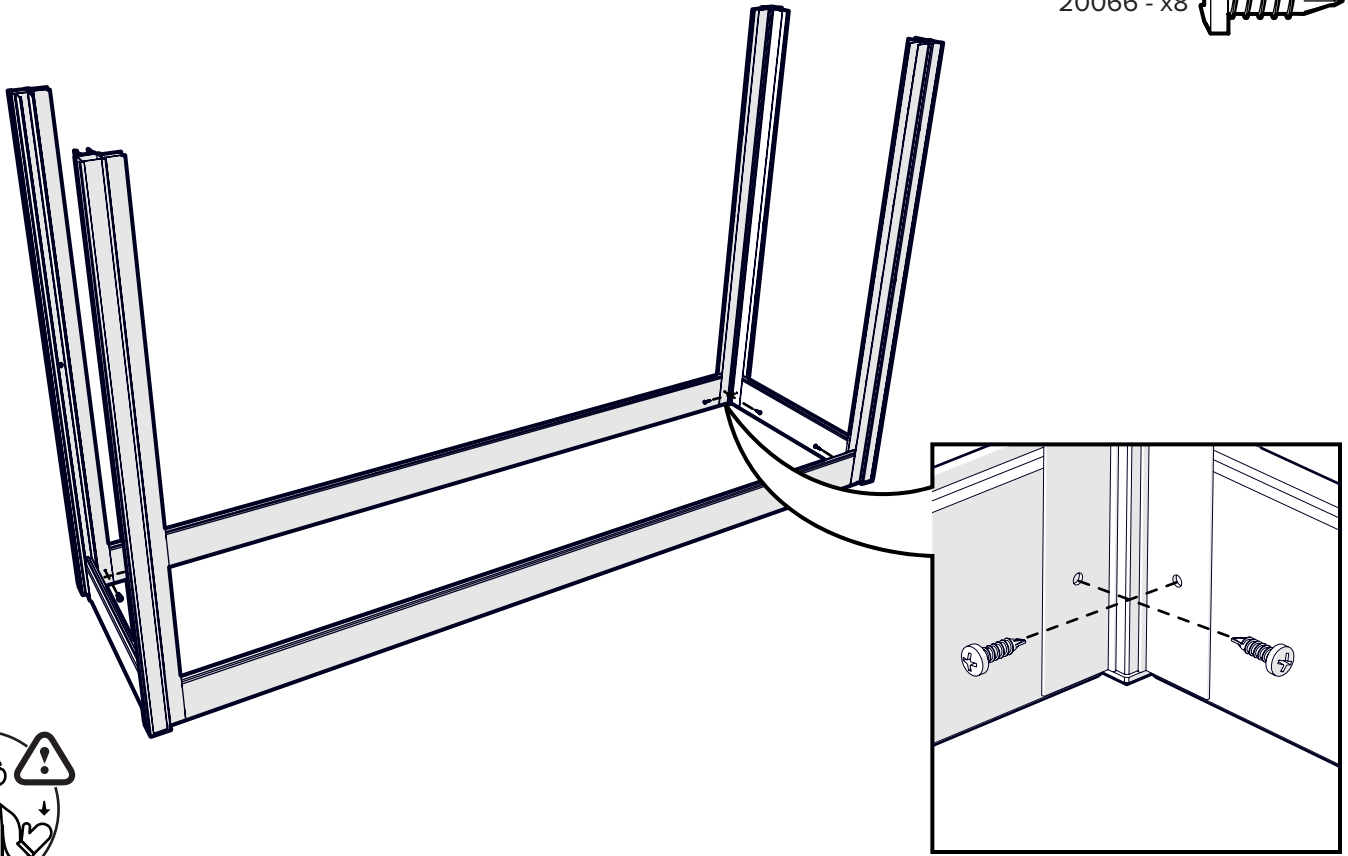

4

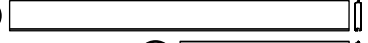
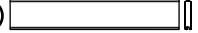
17053 - x12   
17045 - x12 

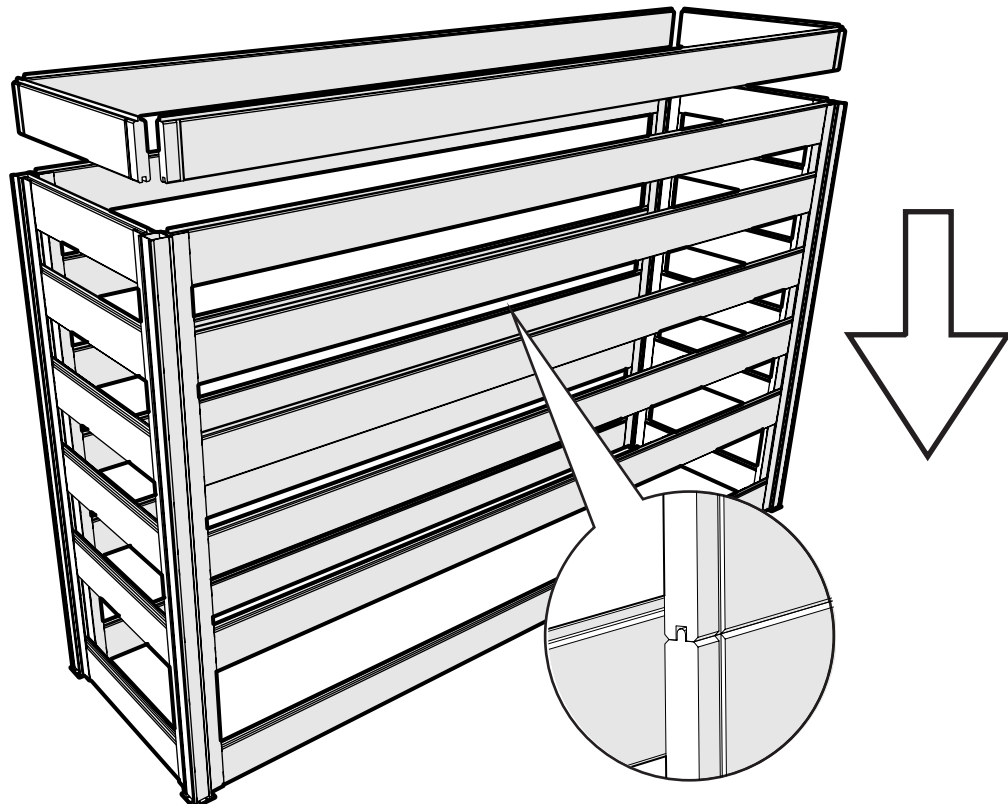

6

5

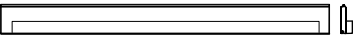
17054 - x2 

17045 - x2 

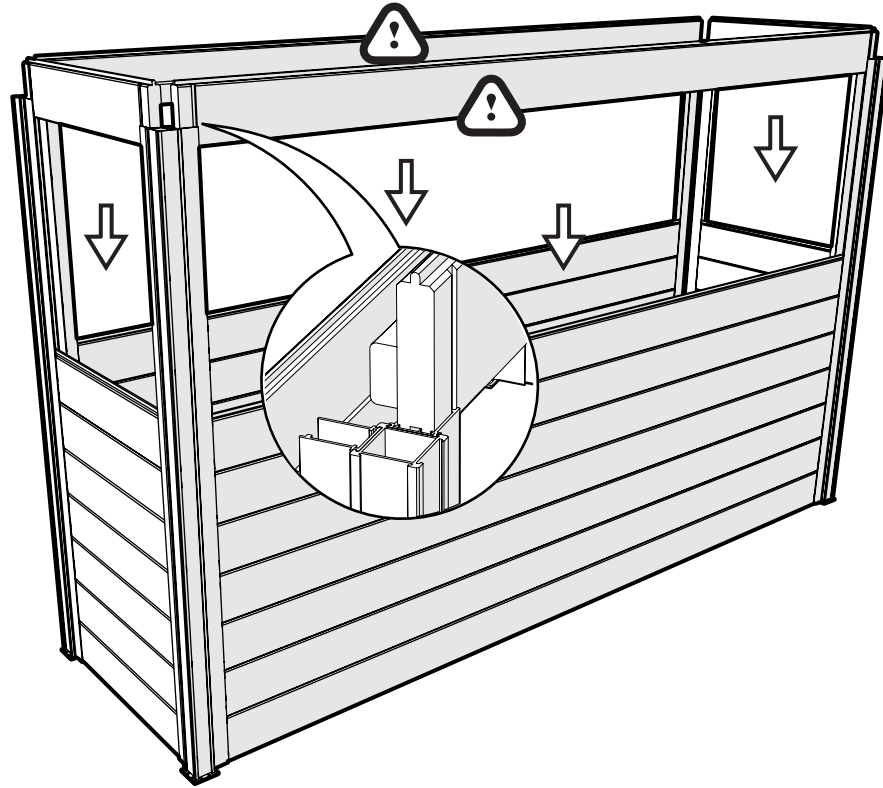

6

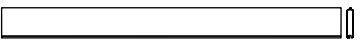
17053 - x6 

17045 - x6 

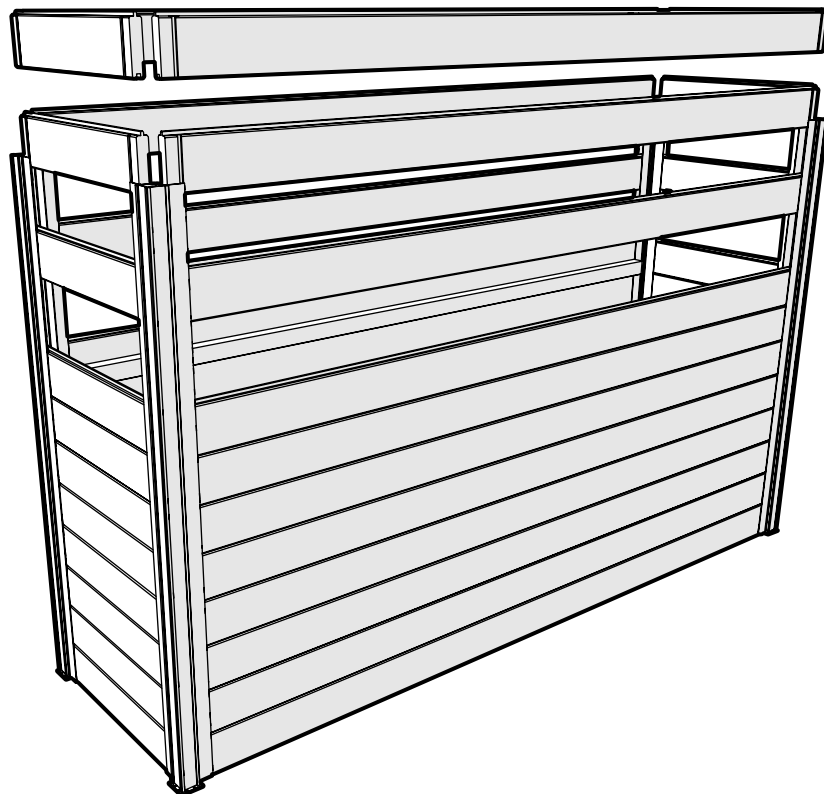

7

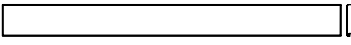
17052 - x2 (A) 

17043 - x2 (B) 

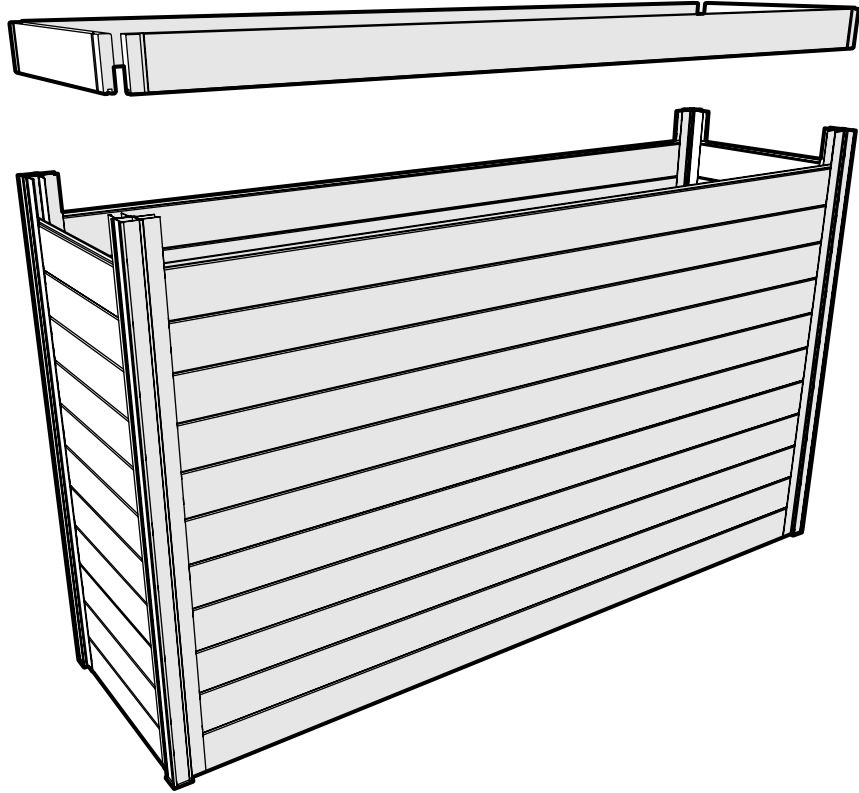

8

17055 - x2 (E) 

17056 - x16 (F) 

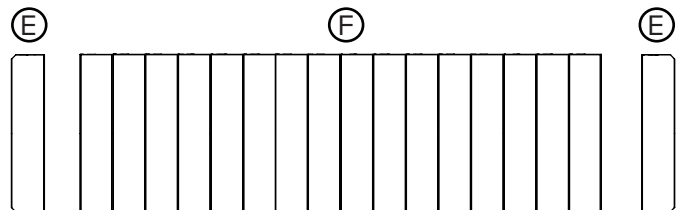
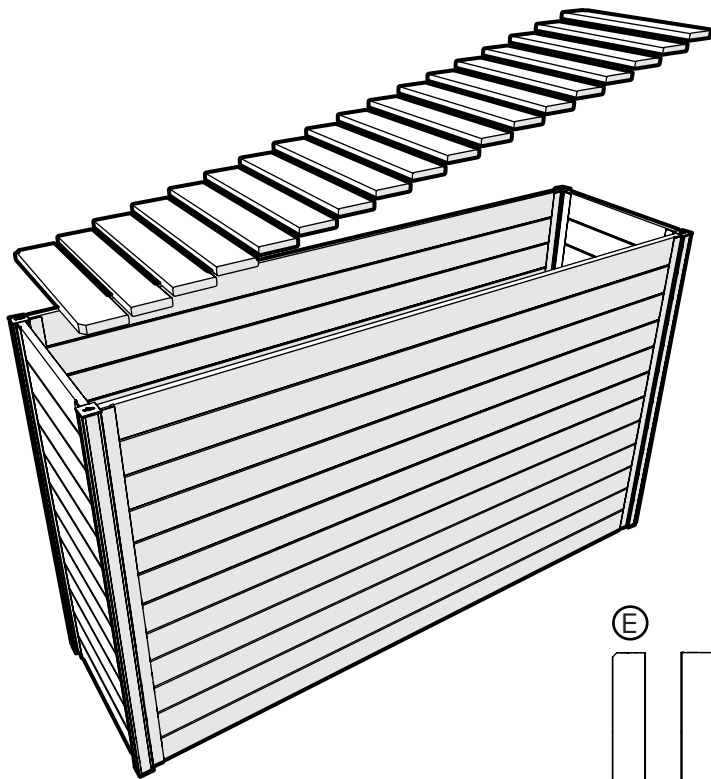



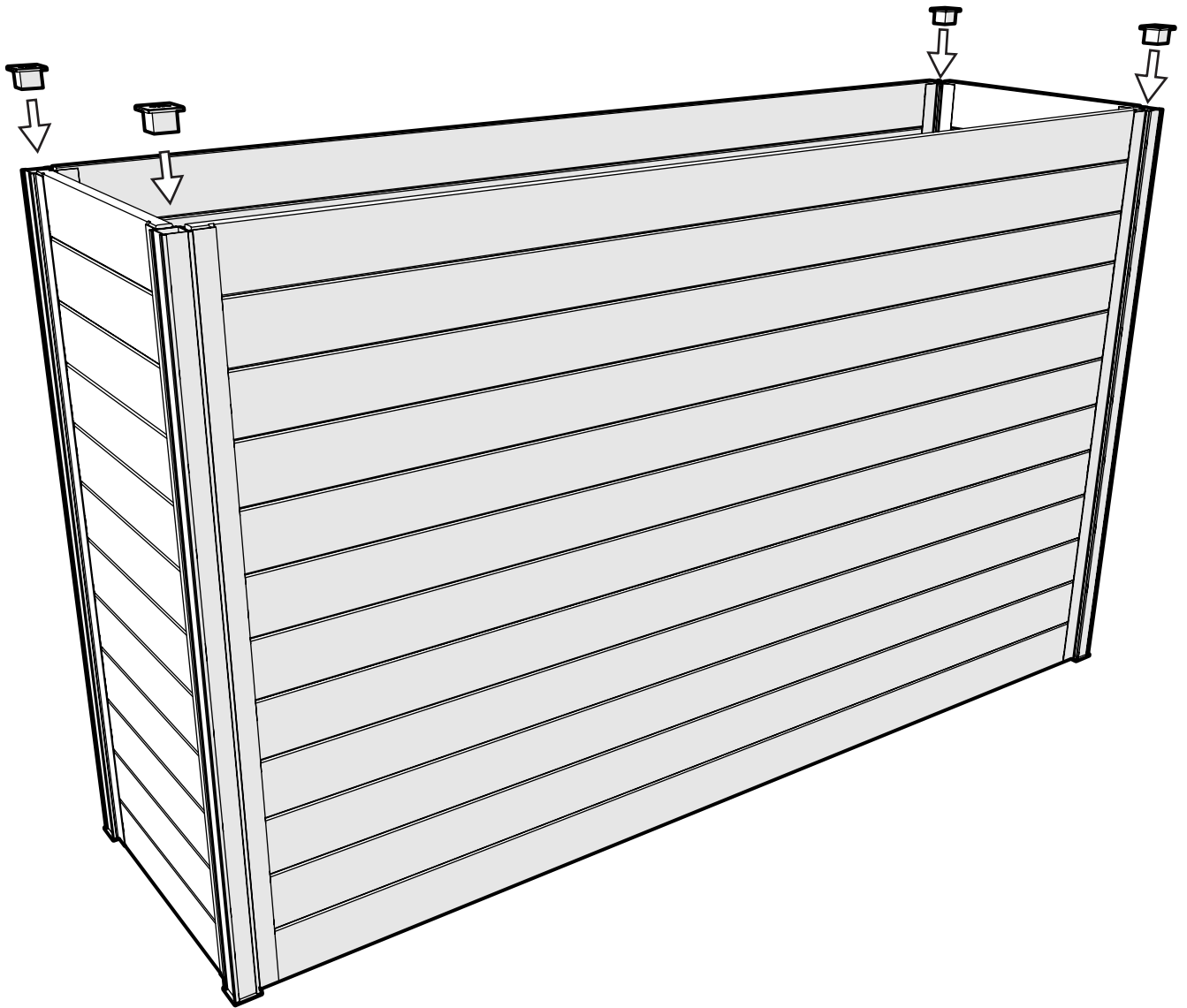

# VT17716

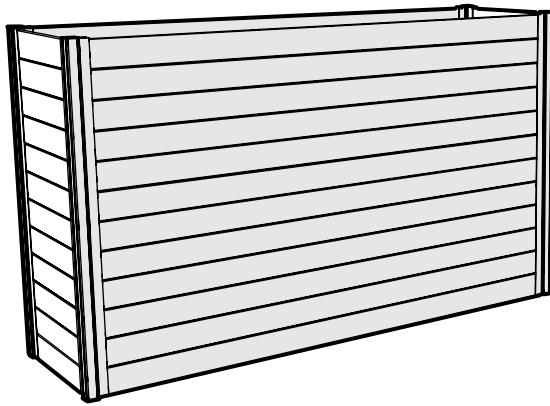

# VT17715

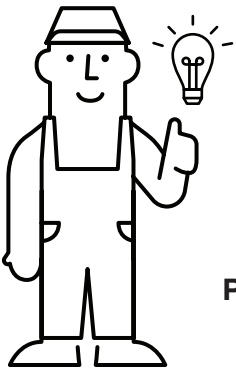
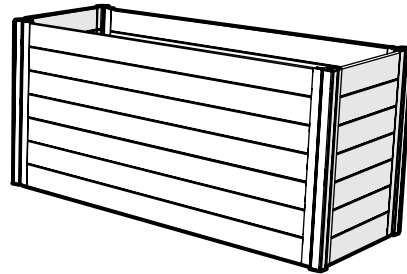

**TRY COMBINING OUR PARKETTES TOGETHER AND CREATE YOUR OWN VARIATIONS TO SATISFY YOUR BACKYARD PLANTING NEEDS!**

**LE PLANCHER PEUT ÊTRE PLACÉ À LA POSITION QUI VOUS CONVIENT. SOUVENEZ-VOUS TOUTEFOIS QUE PLUS VOUS LE PLACEZ HAUT, PLUS VOUS RÉDUISEZ L'ESPACE NÉCESSAIRE POUR VOTRE TERREAU!**

**PUEDA COLOCAR EL SOPORTE DEL SUELO EN CUALQUIER POSICIÓN QUE DESEE. TENGA EN CUENTA QUE CUANTO MÁS ALTO LO UBIQUE, TENDRÁ MENOS ESPACIO PARA LA TIERRA**

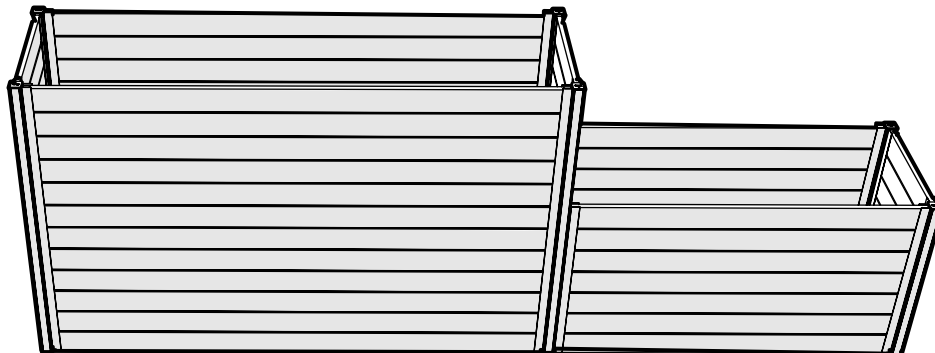
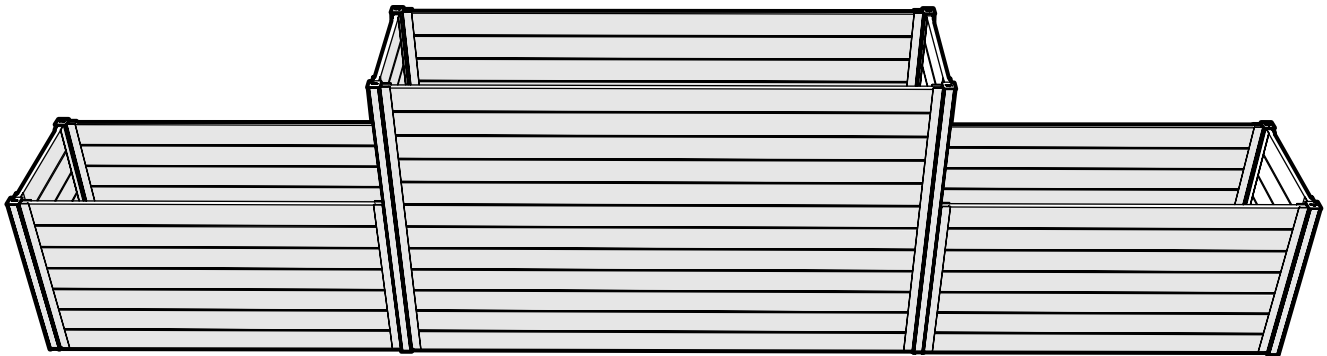

1

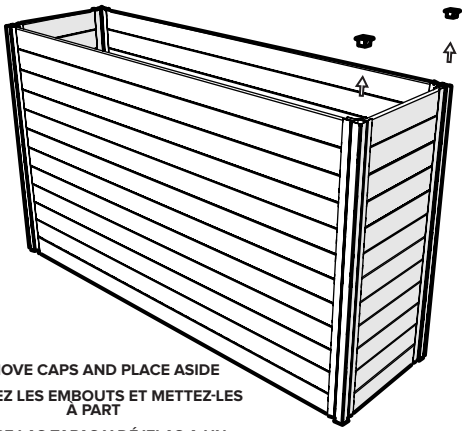

REMOVE CAPS AND PLACE ASIDE  
 ENLEVEZ LES EMBOUTS ET METTEZ-LES  
 À PART  
 RETIRE LAS TAPAS Y DÉJELAS A UN  
 LADO

2

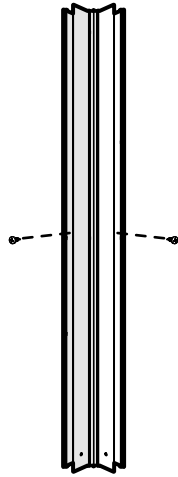

REMOVE SCREWS AND POST. KEEP BOTH  
 C-CHANNELS AS YOU WILL BE USING THEM IN  
 THE NEXT STEP.

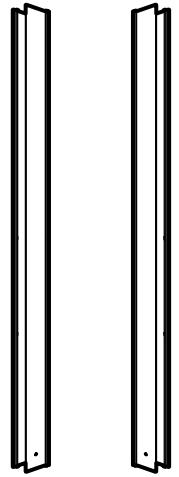

RETIREZ LES VIS ET LE MONTANT. CONSERVEZ  
 LES DEUX CANAUX C TELS QUE VOUS LES  
 UTILISEREZ À L'ÉTAPE SUIVANTE.

QUITE LOS TORNILLOS Y EL POSTE. MANTEN-  
 GA AMBOS CANALES C, YA QUE LOS USARÁ  
 EN EL SIGUIENTE PASO.

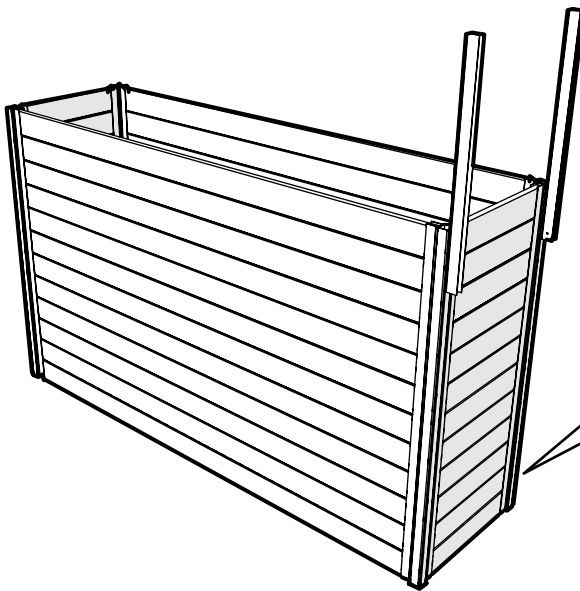

3

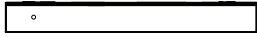

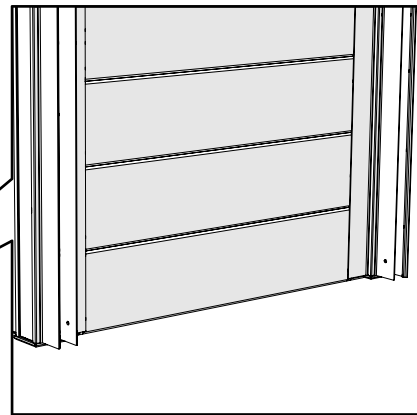

x2   
 x2 

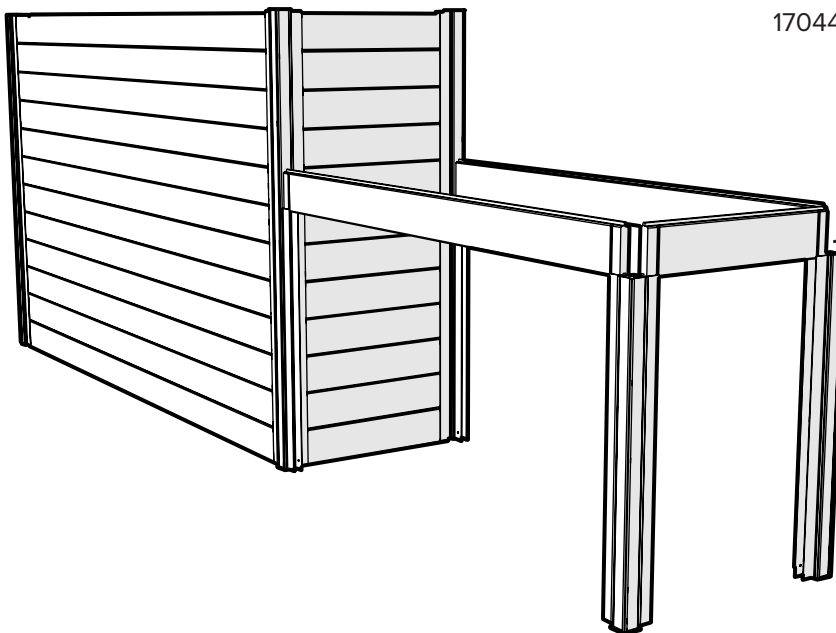

4



17041 - x2   
 17044 - x2   
 17045 - x1 

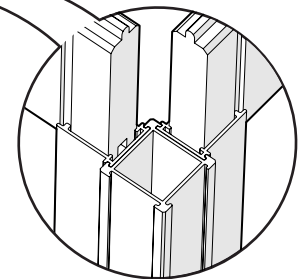

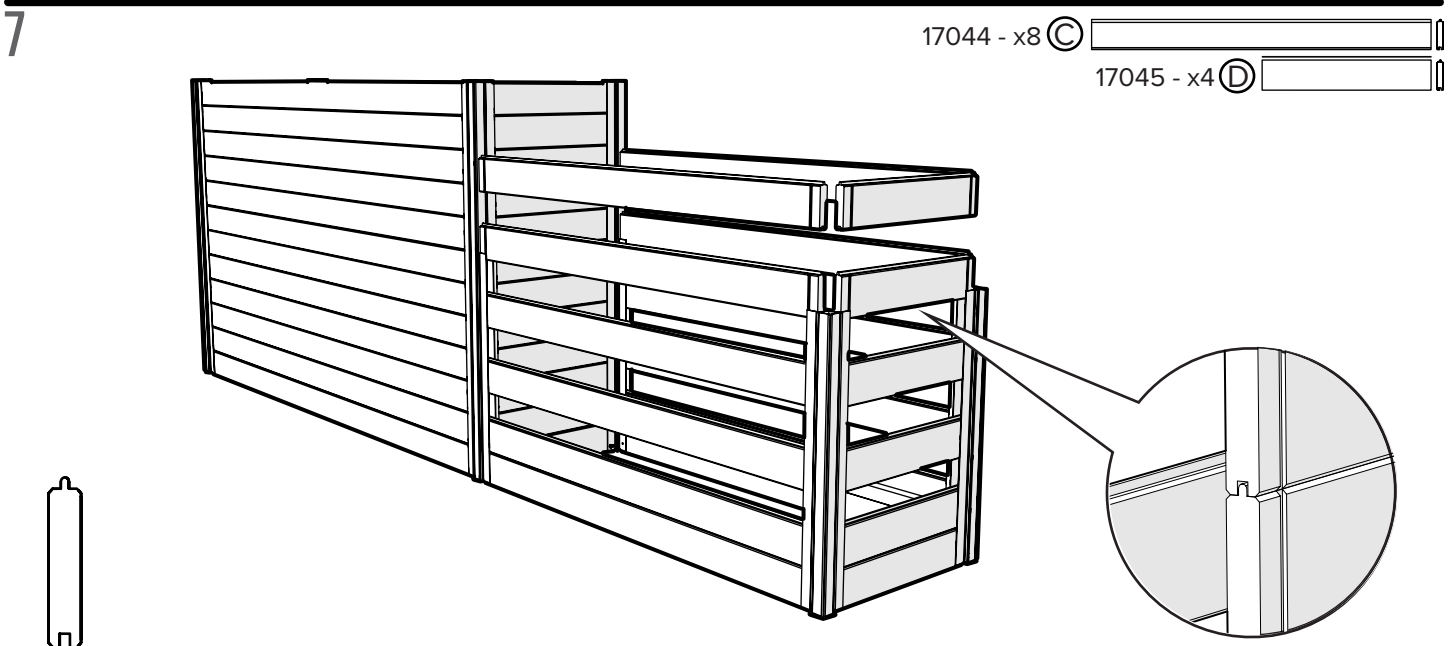
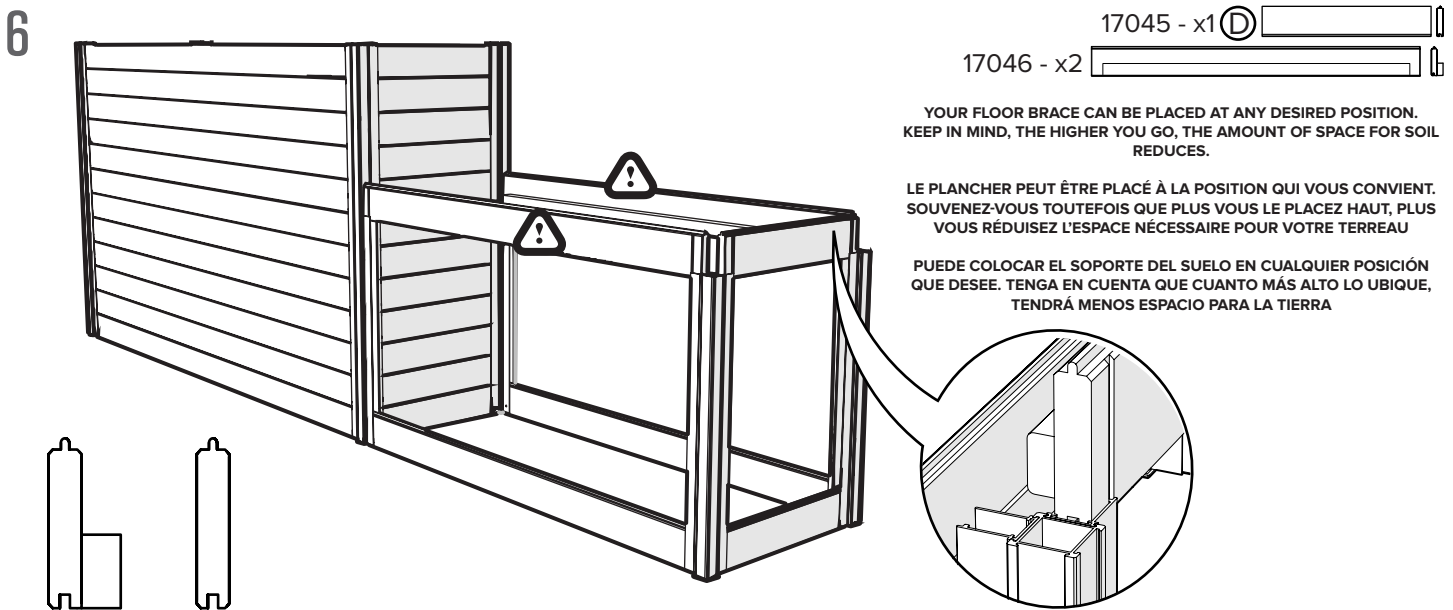
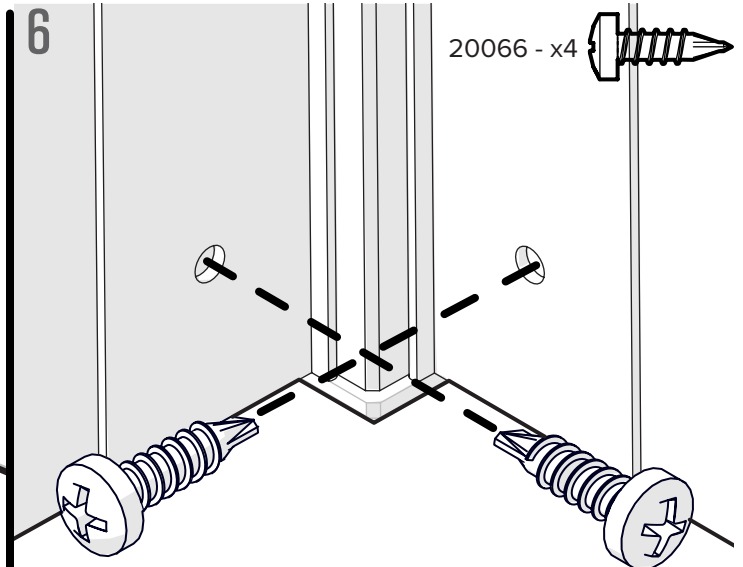
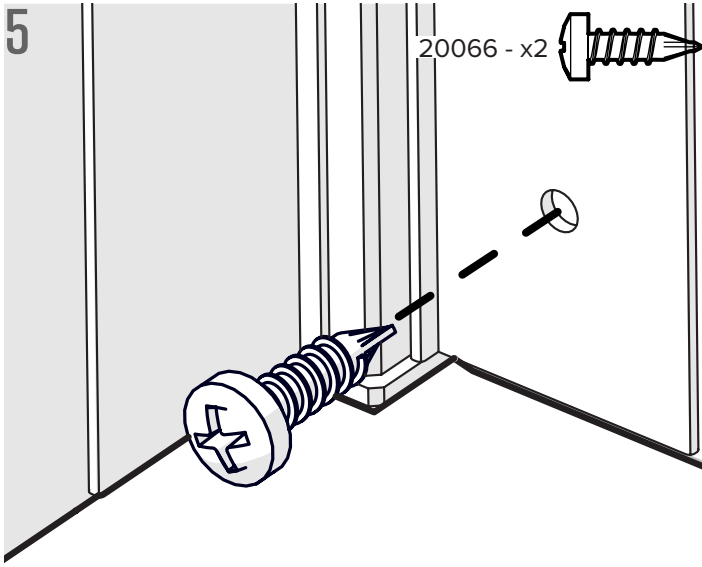

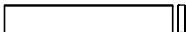

8

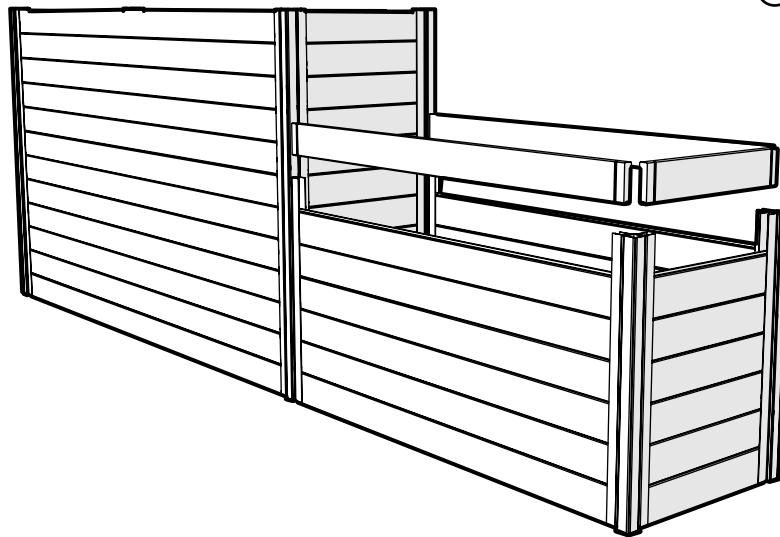
17042 - x2 (A)   
17043 - x1 (B) 

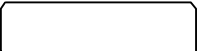

9

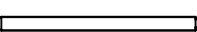
17047 - x2 (E)   
17048 - x10 (F)   
17049 - x1 (G) 

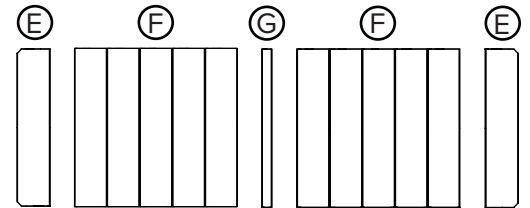
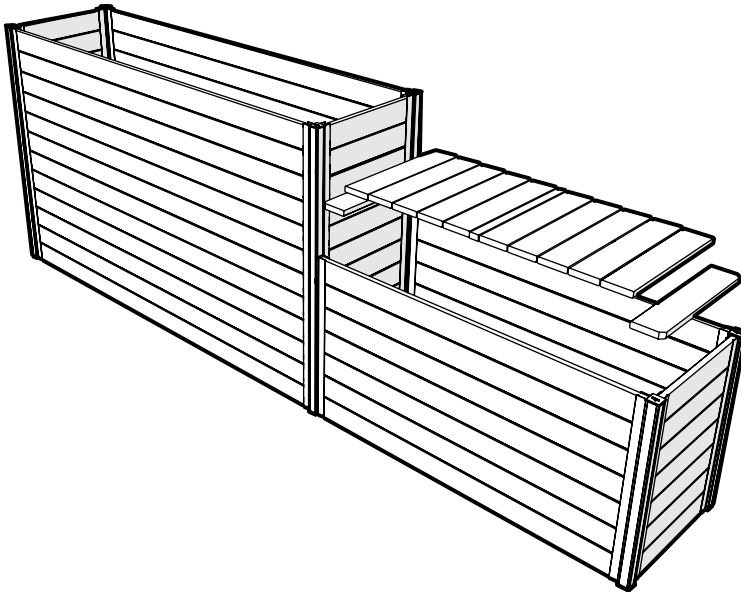

10

17020 - x4 

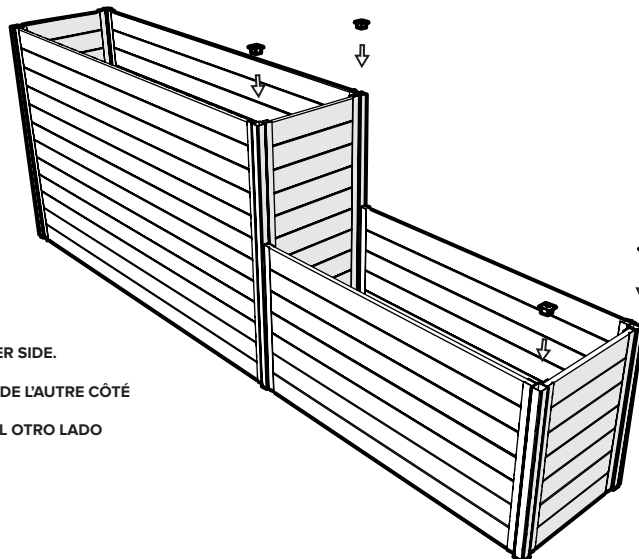

REPEAT STEPS TO BUILD ON THE OTHER SIDE.

RÉPÉTEZ LES ÉTAPES POUR LA CONSTRUCTION DE L'AUTRE CÔTÉ

REPITA LOS PASOS DE CONSTRUCCIÓN EN EL OTRO LADO