



**ASSEMBLY GUIDE
GUIDE DE MONTAGE
GUÍA DE MONTAJE**

URBANA

COMBO PARKLETTE PLANTER

JARDINIÈRE COMBINÉE PARKLETTE

JARDINERA COMBO PARKLETTE

VT17526 / VT17626

ESPRESSO
ESPRESSO
ESPRESSO

SLATE
ARDOISE
PIZARRA

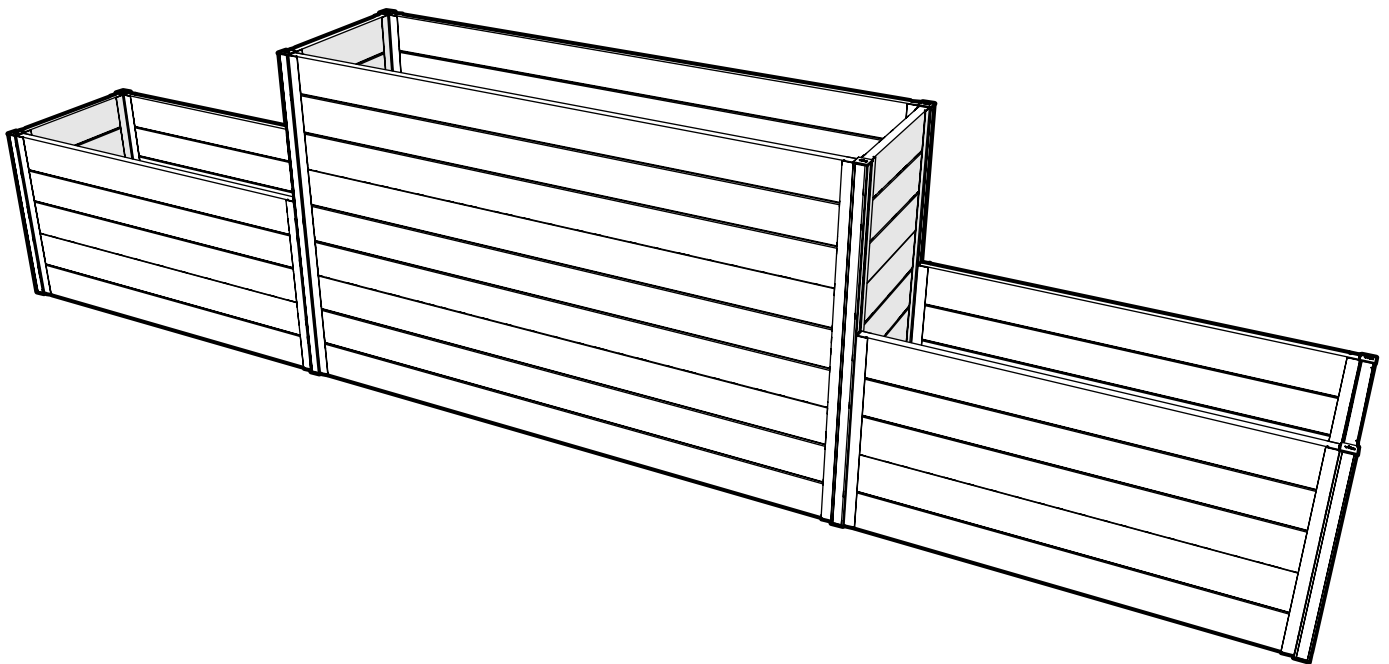

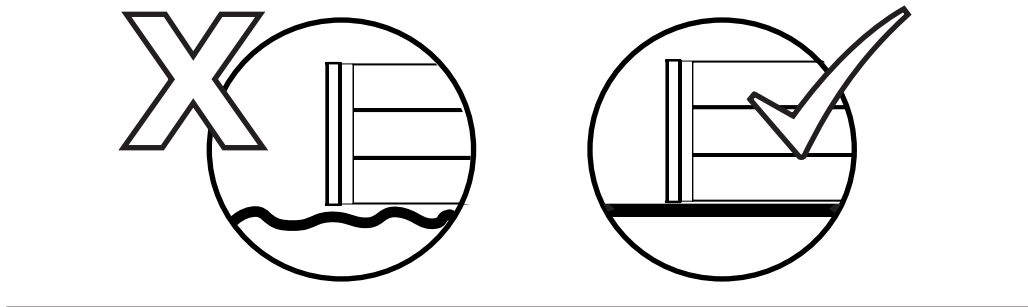
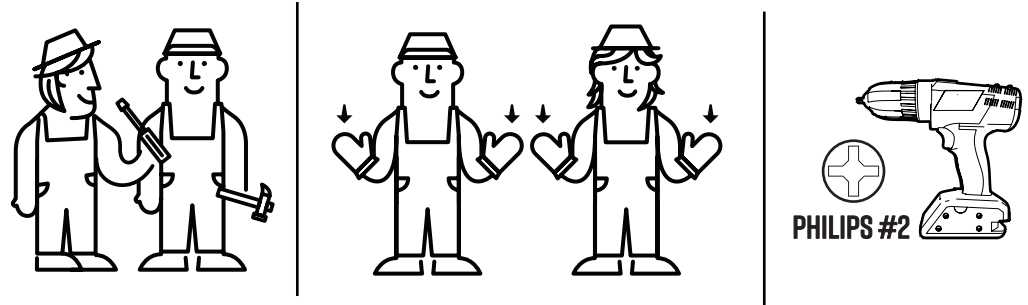
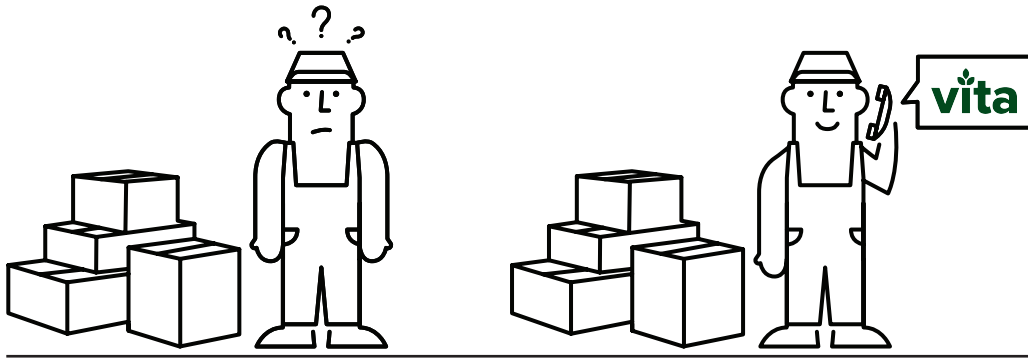

 1-800-282-9346



HELLO@WEAREVITA.COM



WWW.WEAREVITA.COM



8:00 AM - 5:00 PM EST



PARTS LIST

LISTE DES PIÈCES

LISTA DE PARTES



16030 - SLATE - ARDOISE - PIZARRA
15030 - ESPRESSO - EXPRESSO - ESPRESSO
BOARD A - PLANCHE A - TABLERO A
54 1/2 IN (138.4 CM) - **X2**

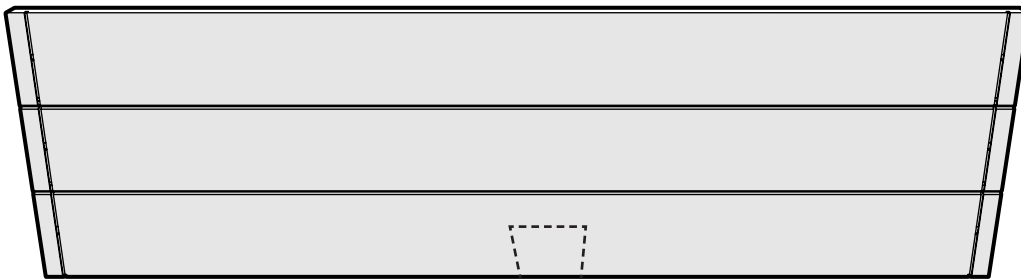

16148 - SLATE - ARDOISE - PIZARRA
15148 - ESPRESSO - EXPRESSO - ESPRESSO
BOARD B - PLANCHE B - TABLERO B
54 1/2 IN (138.4 CM) - **X4**



16020 - SLATE - ARDOISE - PIZARRA
15020 - ESPRESSO - EXPRESSO - ESPRESSO
BOARD C - PLANCHE C - TABLERO C
36 3/8 IN (92.4 CM) - **X4**



16021 - SLATE - ARDOISE - PIZARRA
15021 - ESPRESSO - EXPRESSO - ESPRESSO
BOARD D - PLANCHE D - TABLERO D
36 3/8 IN (92.4 CM) - **X4**

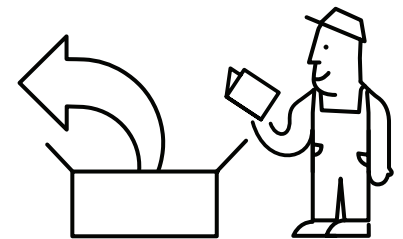



16022 - SLATE - ARDOISE - PIZARRA

15022 - ESPRESSO - EXPRESSO - ESPRESSO

BOARD E - PLANCHE D - TABLERO D

13 5/8 IN (34.7 CM) - **X8**



16023 - SLATE - ARDOISE - PIZARRA

15023 - ESPRESSO - EXPRESSO - ESPRESSO

BOARD F - PLANCHE F - TABLERO F

13 5/8 IN (34.7 CM) - **X2**



16032 - SLATE - ARDOISE - PIZARRA

15032 - ESPRESSO - EXPRESSO - ESPRESSO

FLOOR BOARD G - PLANCHE D'ÉTAGE G - TABLERO DE PISO G

14 IN (35.8 CM) - **X2**



16033 - SLATE SLATE - ARDOISE - PIZARRA

15033 - ESPRESSO - EXPRESSO - ESPRESSO

FLOOR BOARD H - PLANCHE D'ÉTAGE H - TABLERO DE PISO H

14 IN (35.8 CM) - **X3**

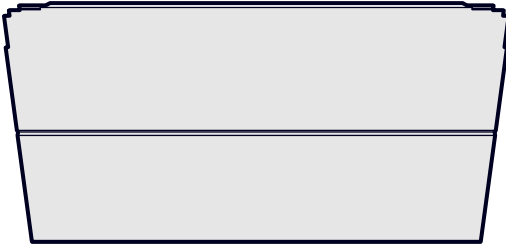

16024 - SLATE - ARDOISE - PIZARRA

15024 - ESPRESSO - EXPRESSO - ESPRESSO

FLOOR BOARD I - PLANCHE D'ÉTAGE I - TABLERO DE PISO I

14 IN (35.8 CM) - **X4**



16025 - SLATE - ARDOISE - PIZARRA

15025 - ESPRESSO - EXPRESSO - ESPRESSO

FLOOR BOARD J - PLANCHE D'ÉTAGE J - TABLERO DE PISO J

14 IN (35.8 CM) - **X6**



16028 - SLATE - ARDOISE - PIZARRA

15028 - ESPRESSO - EXPRESSO - ESPRESSO

CROSS BRACE K - ENTRETOISE K - BRAZO CRUZADO K

13 3/4 IN (35.2 CM) - **X3**



16031 - SLATE SLATE - ARDOISE - PIZARRA

15031 - ESPRESSO - EXPRESSO - ESPRESSO

FLOOR BRACE L - BRACE DE PLANCHER L - BRACE DE PISO L

54 1/2 IN (138.4 CM) - **X2**

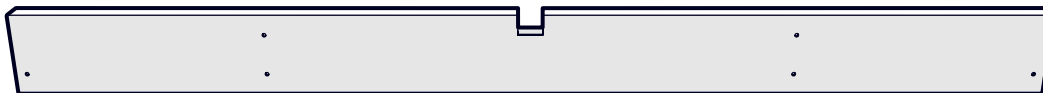

16026 - SLATE SLATE - ARDOISE - PIZARRA

15026 - ESPRESSO - EXPRESSO - ESPRESSO

FLOOR BRACE M - BRACE DE PLANCHER M - BRACE DE PISO M

36 3/8 IN (92.4 CM) - **X4**



16029

POST O - PUBLIER O - EXPONER O

33" (83.7 CM) - **X2**



16044
POST P - PUBLIER P - EXPONER P
33" (83.7 CM) - **X2**



16250
C-CHANNEL Q - C-CHAÎNE Q - C-CANNAL Q
18 1/4" (46.5 CM) - **X4**



16251
C-CHANNEL R - C-CHAÎNE R - C-CANNAL R
18 1/4" (46.5 CM) - **X4**



16252
C-CHANNEL S - C-CHAÎNE S - C-CANNAL S
18 1/4" (46.5 CM) - **X2**



16253
C-CHANNEL T - C-CHAÎNE T - C-CANNAL T
18 1/4" (46.5 CM) - **X2**



16254
POST U - PUBLIER U - EXPONER U
18 1/4" (46.5 CM) - **X4**



16325
POST CAP
ETE DE POTEAU
TAPON
X16



16067
LOCKING TAB
ONGLET DE VERROUILLAGE
PESTAÑA DE BLOQUEO
X2

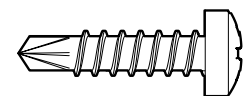

20066
SCREW
VISSER S
TORNILLO S
5/8IN (1.6CM)
X12

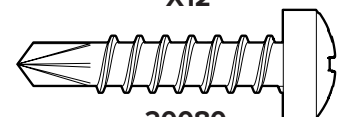

20080
SCREW
VISSER T
TORNILLO T
1 1/4IN (3.2CM)
X40

PRODUCT DIMENSIONS

DIMENSIONS DU PRODUIT

DIMENSIONES DEL PRODUCTO

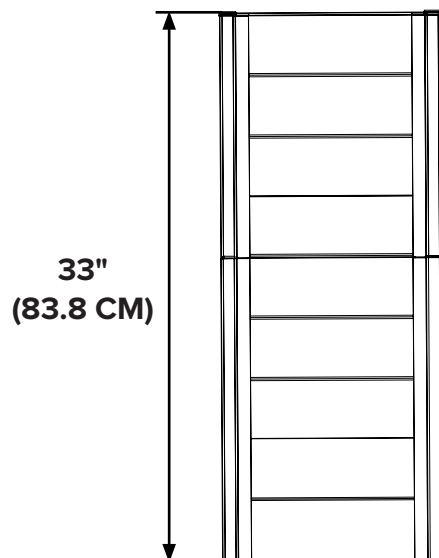
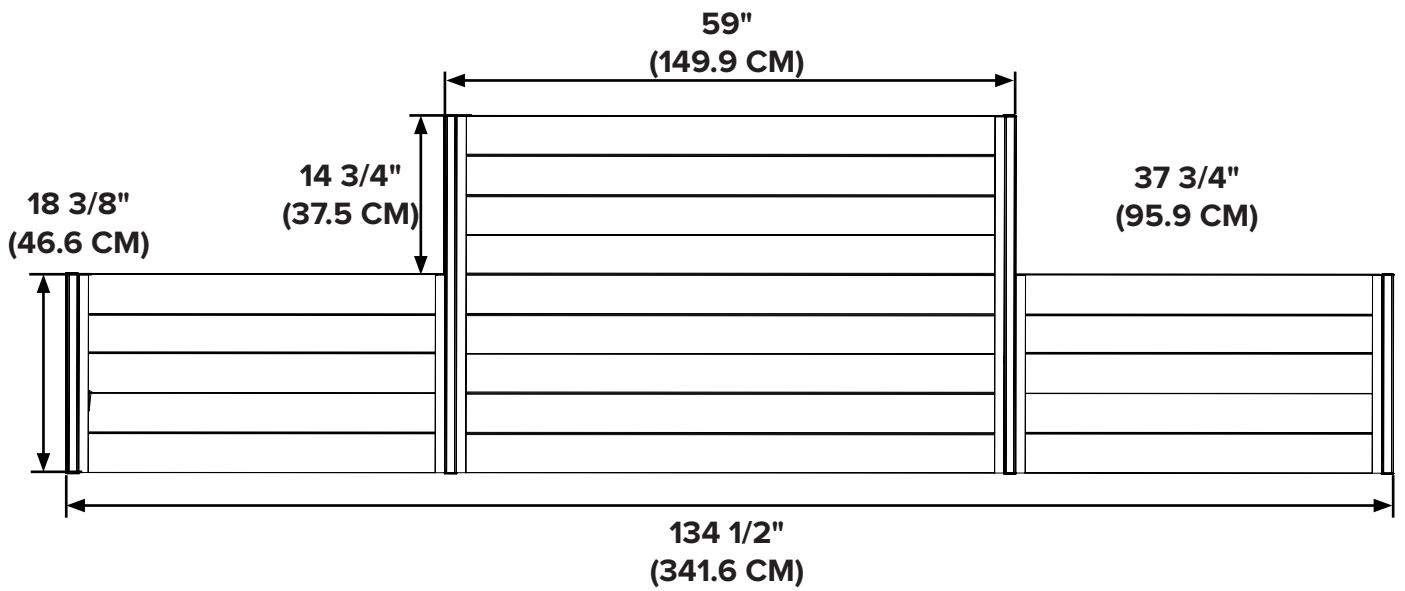
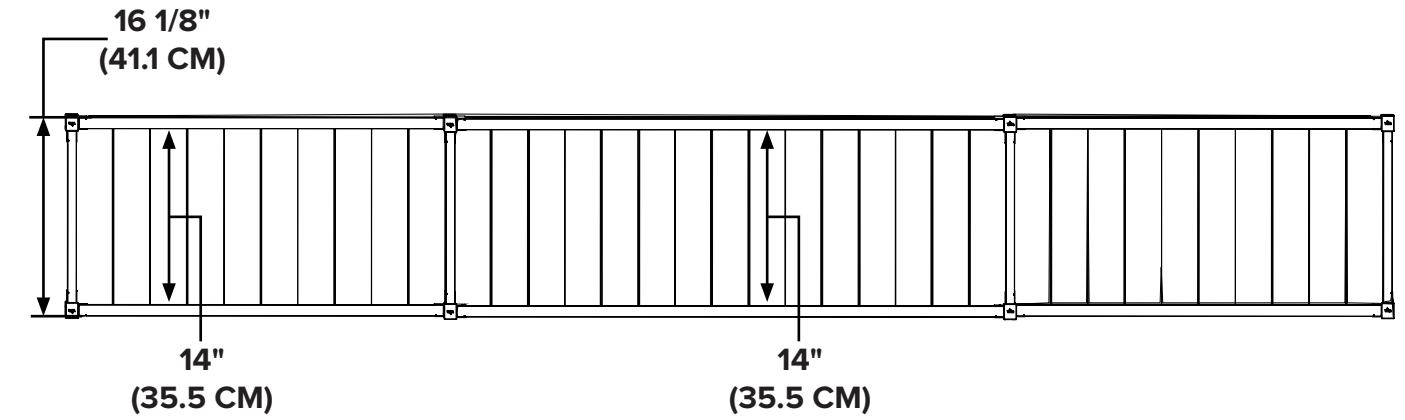

SOIL CAPACITY



CAPACITÉ DU SOL

CAPACIDAD DEL SUELO

SMALL PARKLETTE

JARDINÈRA MINI PARKLETTE

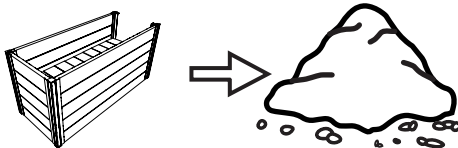
PLANTADOR DE MINI PARKLETTE

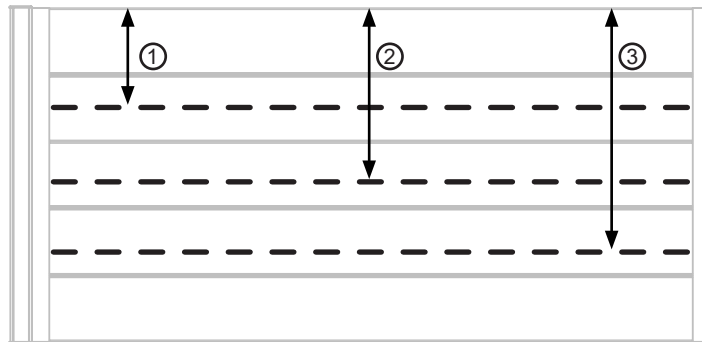

			
False Bottom	Depth	Soil Capacity	Bags of Soil
①	3 5/8" (9.1 cm)	1.1 cubic feet (30.6 liters)	x1
②	7 5/8" (19.3cm)	2.3 cubic feet (64.7 liters)	x2
③	11 5/8" (29.4cm)	3.5 cubic feet (98.7 liters)	x4



LARGE PARKLETTE

GRAND PLANTEUR DE PARKLETTE

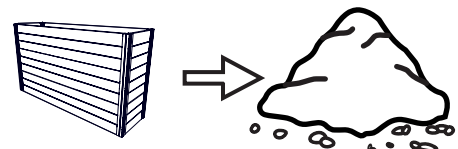
GRAN PARKLETTE PLANTER

			
False Bottom	Depth	Soil Capacity	Bags of Soil
①	8 5/8" (22.1cm)	4.0 cubic feet (113.0 liters)	x4
②	14 5/8" (37.3cm)	6.8 cubic feet (191.8 liters)	x7
③	21 5/8" (52.5cm)	10.0 cubic feet (283.7 liters)	x10

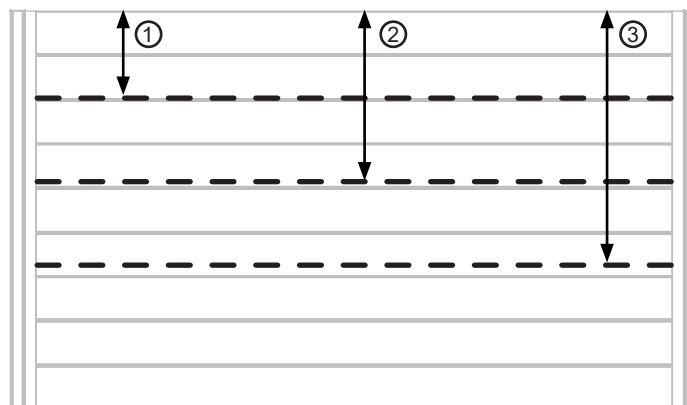

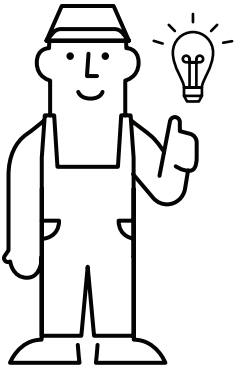

THESE THREE SCREW HOLES ALLOW YOU TO POSITION YOUR FLOOR BRACE AT DIFFERENT DEPTHS. CHOOSE YOUR DEPTH ACCORDING TO WHAT YOU WILL BE PLANTING AND HOW MUCH SOIL IS NEEDED!

CES TROIS TROUS DE VIS VOUS PERMETTENT DE POSITIONNER VOTRE CONTREVENTEMENT À DIFFÉRENTES PROFONDEURS. CHOISISSEZ VOTRE PROFONDEUR EN FONCTION DE CE QUE VOUS ALLEZ PLANTER ET DE LA QUANTITÉ DE TERRE NÉCESSAIRE!

ESTOS TRES ORIFICIOS PARA TORNILLOS LE PERMITEN COLOCAR LA RIOSTRA DEL PISO A DIFERENTES PROFUNDIDADES. ¡ELIJA SU PROFUNDIDAD DE ACUERDO CON LO QUE VA A PLANTAR Y LA CANTIDAD DE TIERRA QUE SE NECESITA!

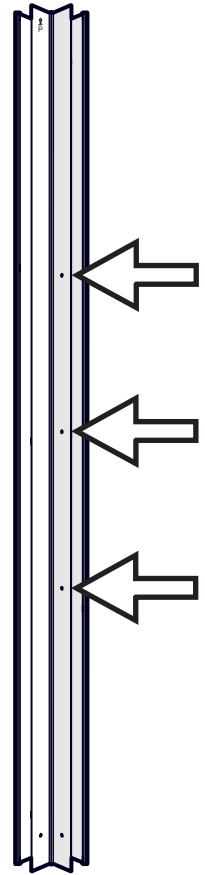

- 16030/15030 - x2 (A)
- 16148/15148 - x4 (B)
- 16067 - x2
- 16029 - x2 (O)
- 16044 - x2 (P)

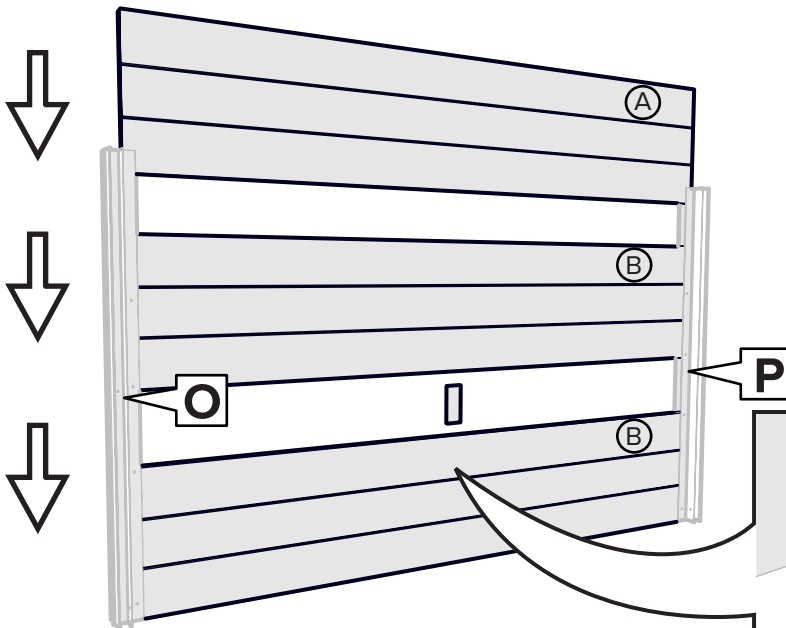



X2

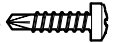

2

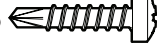
20066 - x4 

20080 - x16 

16031/15031 - x2 

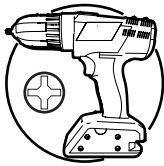
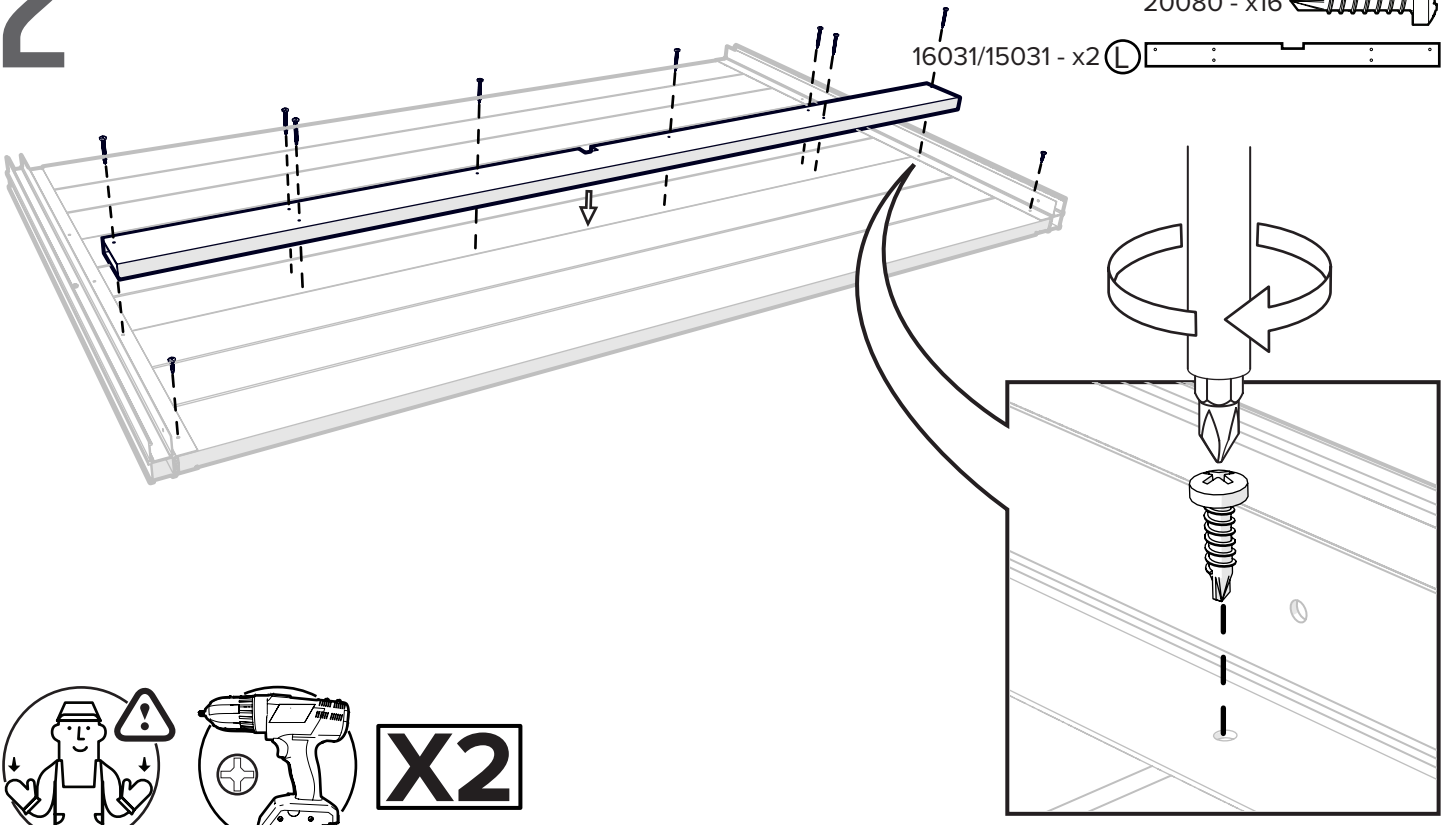

X2

PHILIPS #2

3

16022/15022 - x6 

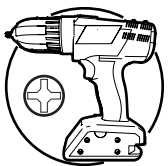
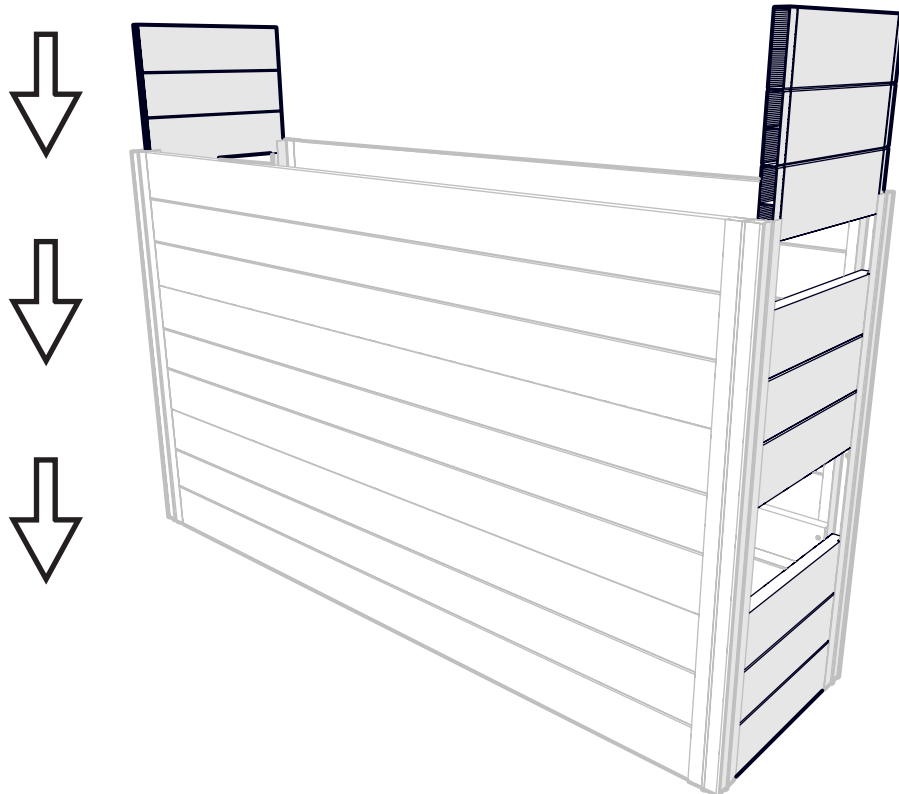

PHILIPS #2

4

20066 - x4 

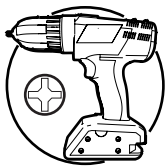
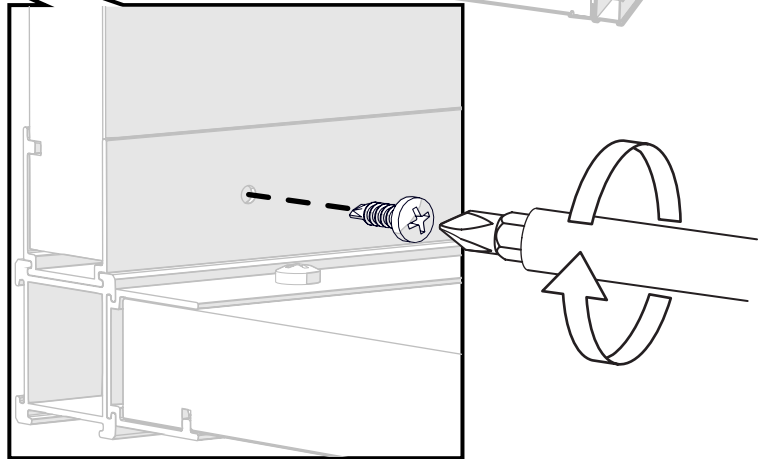
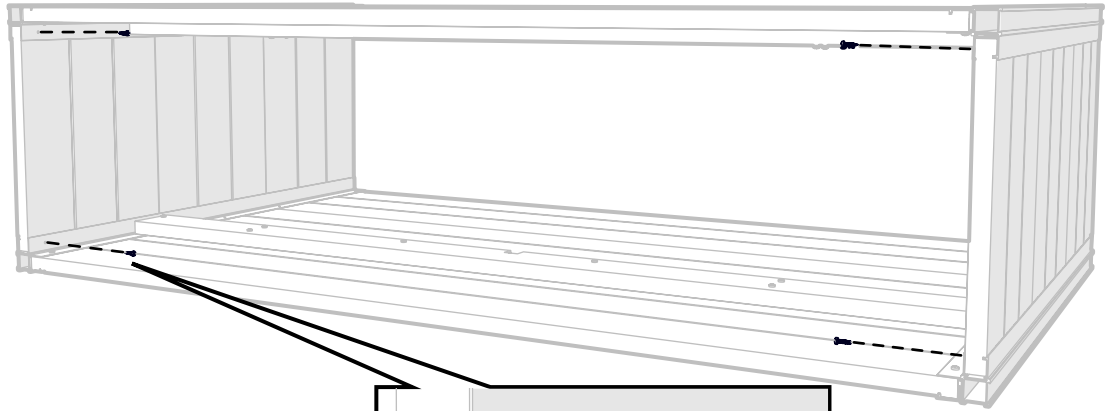

PHILIPS #2

5

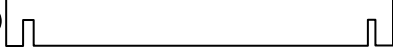
16028/15028 - x1 

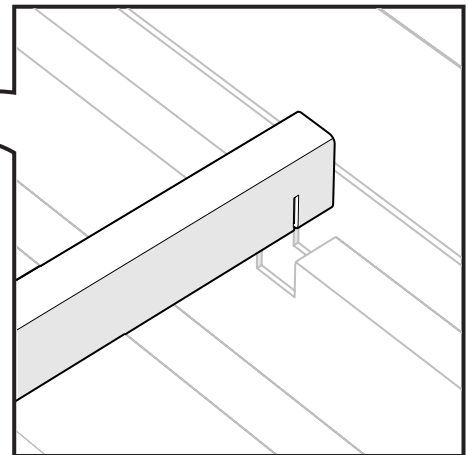
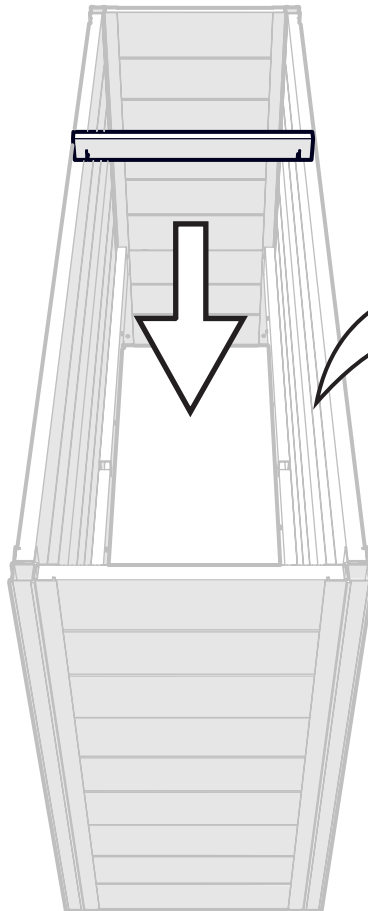

6



16032/15032 - x2 (G)



16033/15033 - x3 (H)

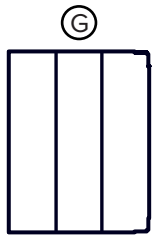
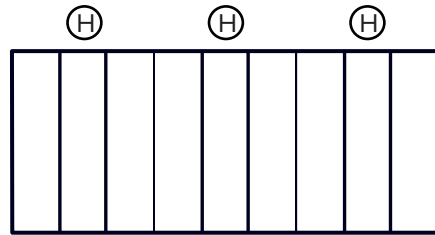
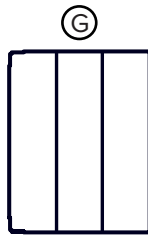
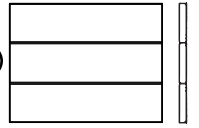

7

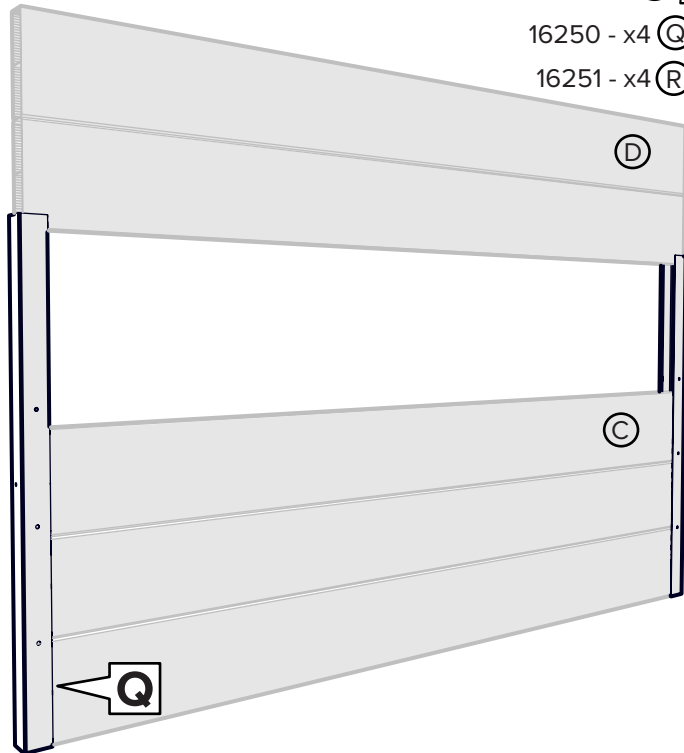

16020/15020 - x4 (C)

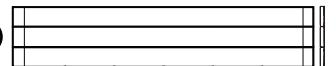

16021/15021 - x4 (D)

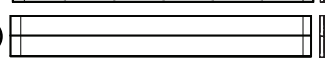

16250 - x4 (Q)

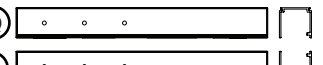

16251 - x4 (R)



X4

8

15026/16026 - x4 (M)

20080 - x24

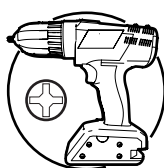
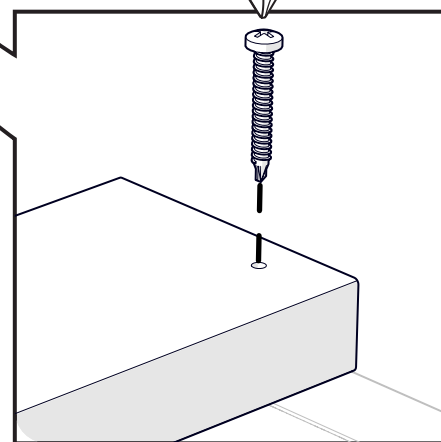
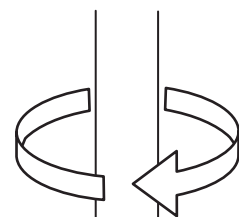
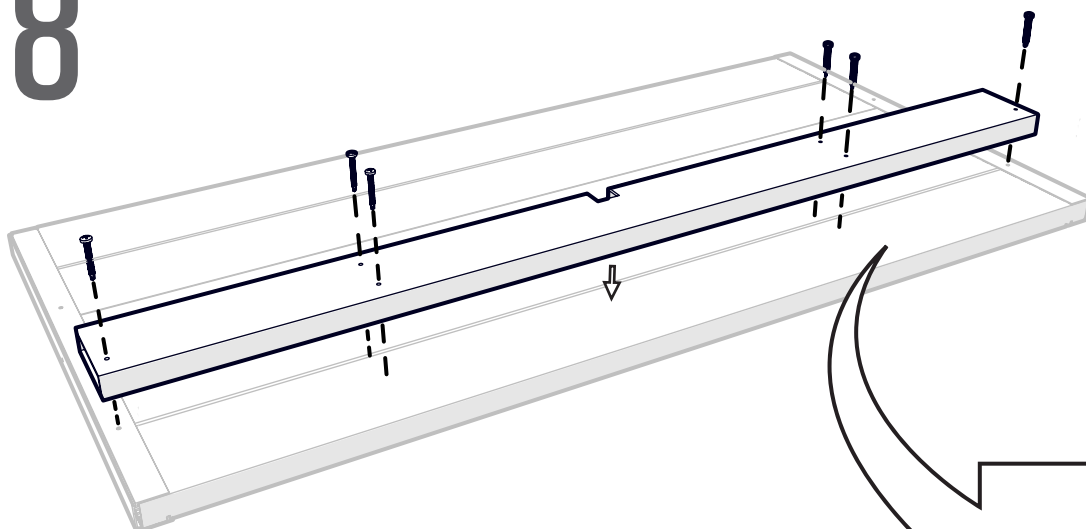

X4

PHILIPS #2

9

16023/15023 - x2 (F)

16022/15022 - x2 (E)

16252 - x2 (S)

16253 - x2 (T)

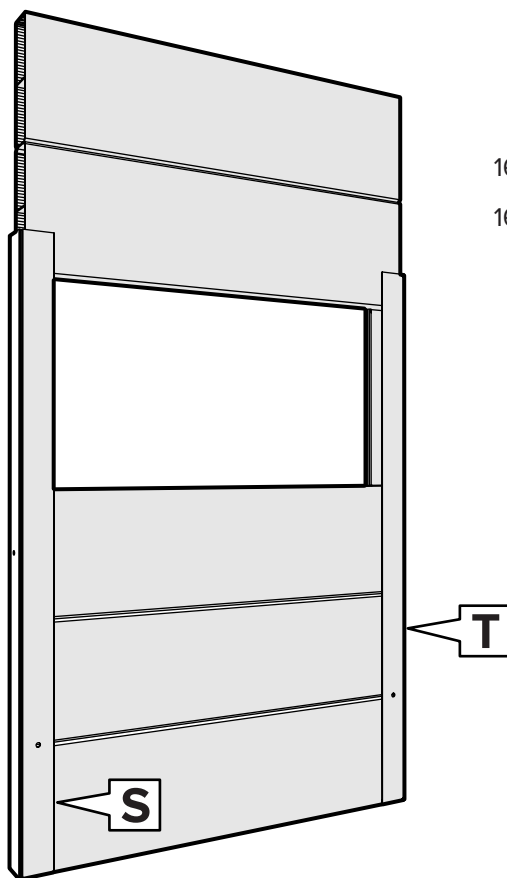

X2

10

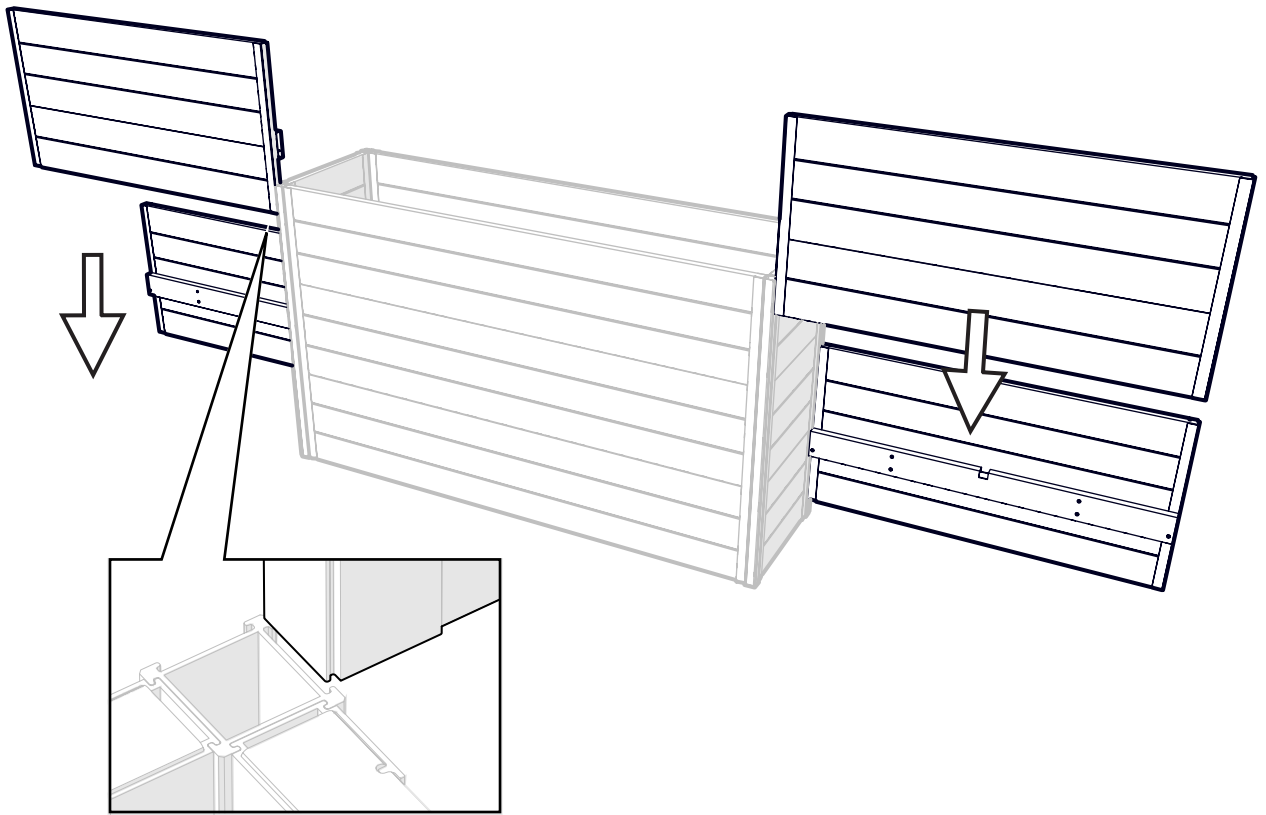

11

16254 - x4 

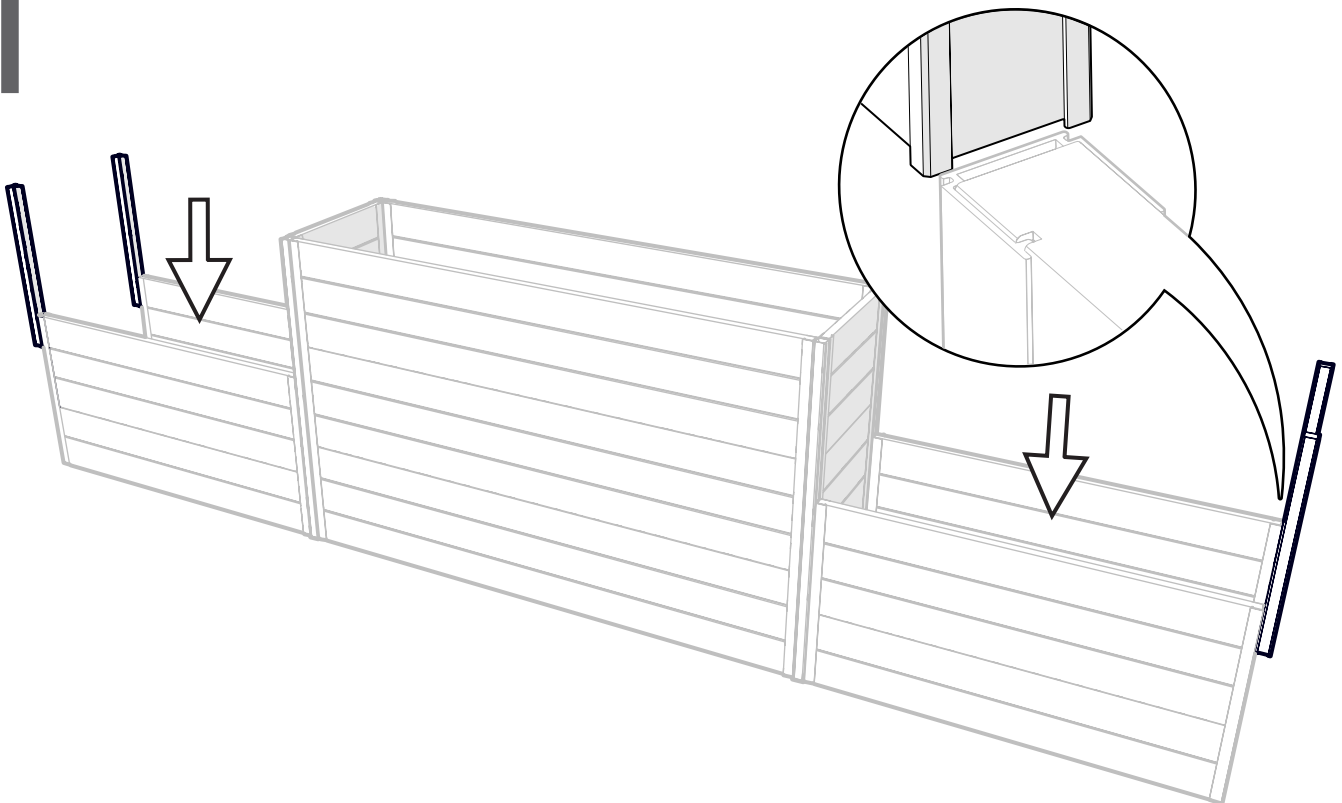

12

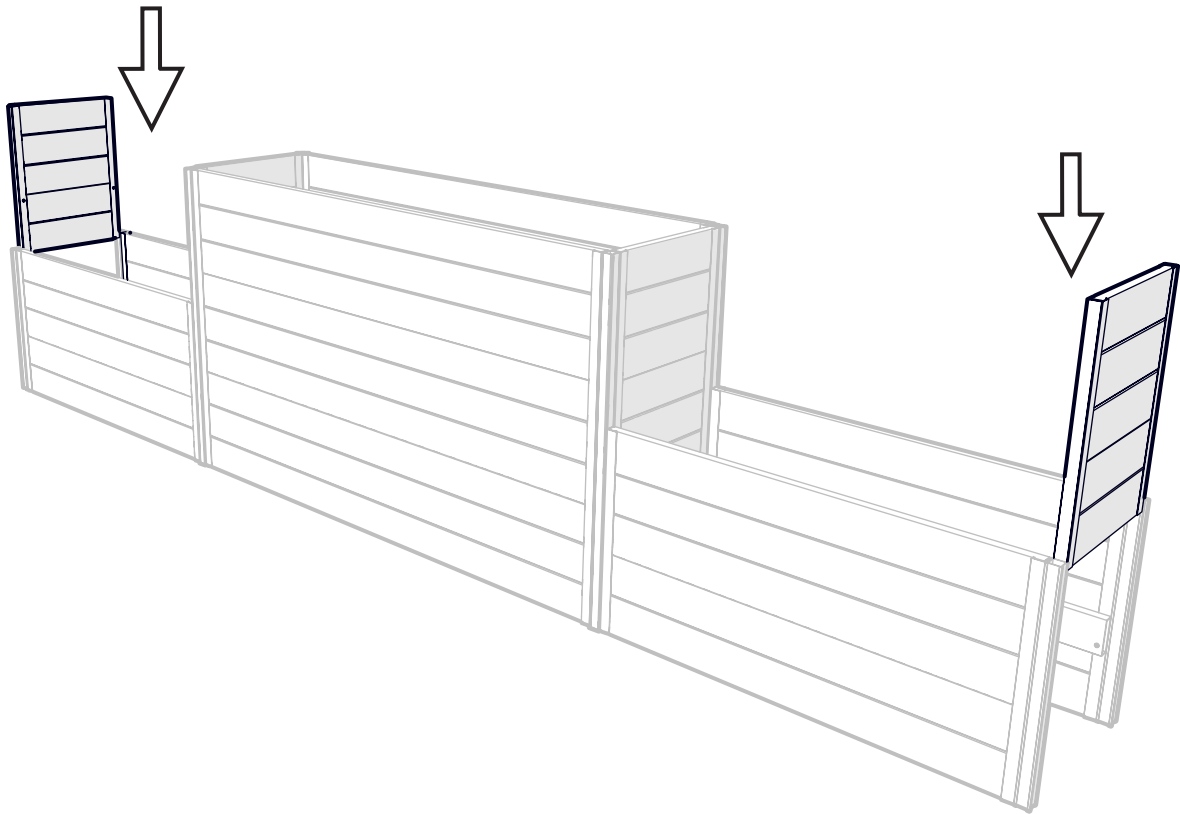

13

16028/15028 - x1

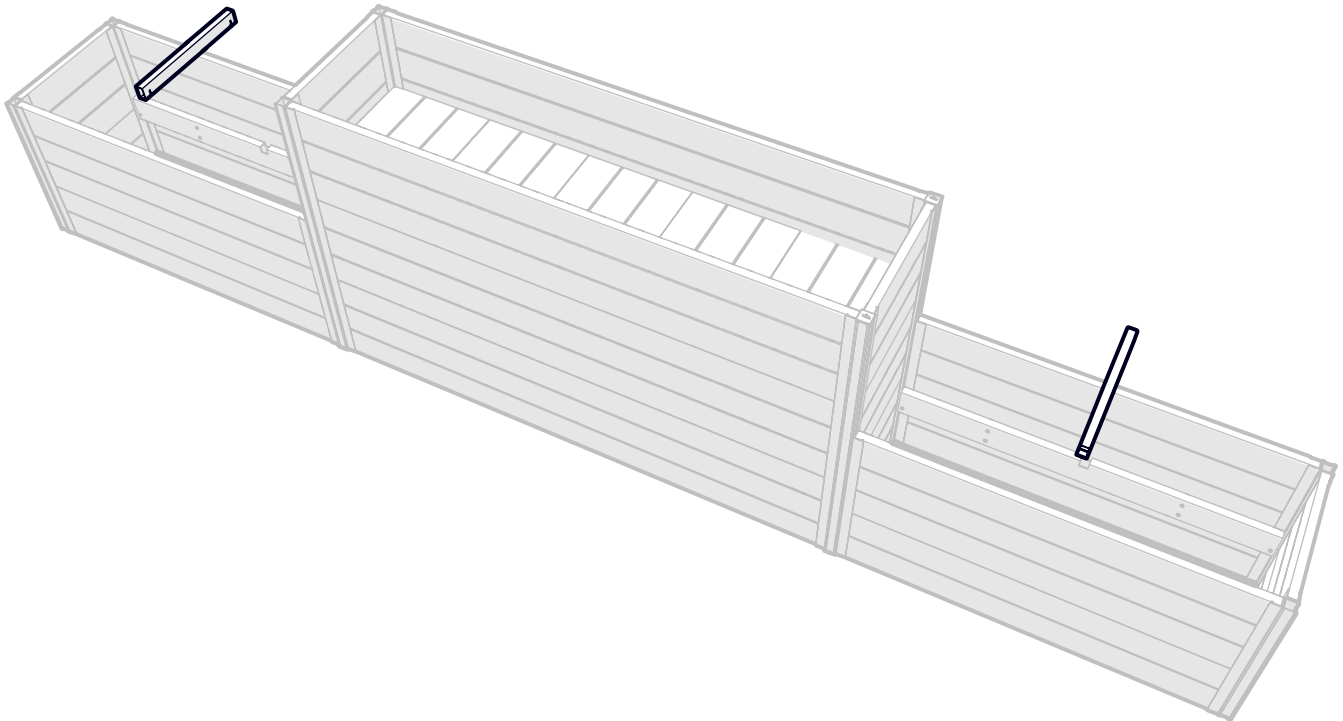
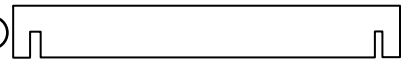

14

16325 - x8

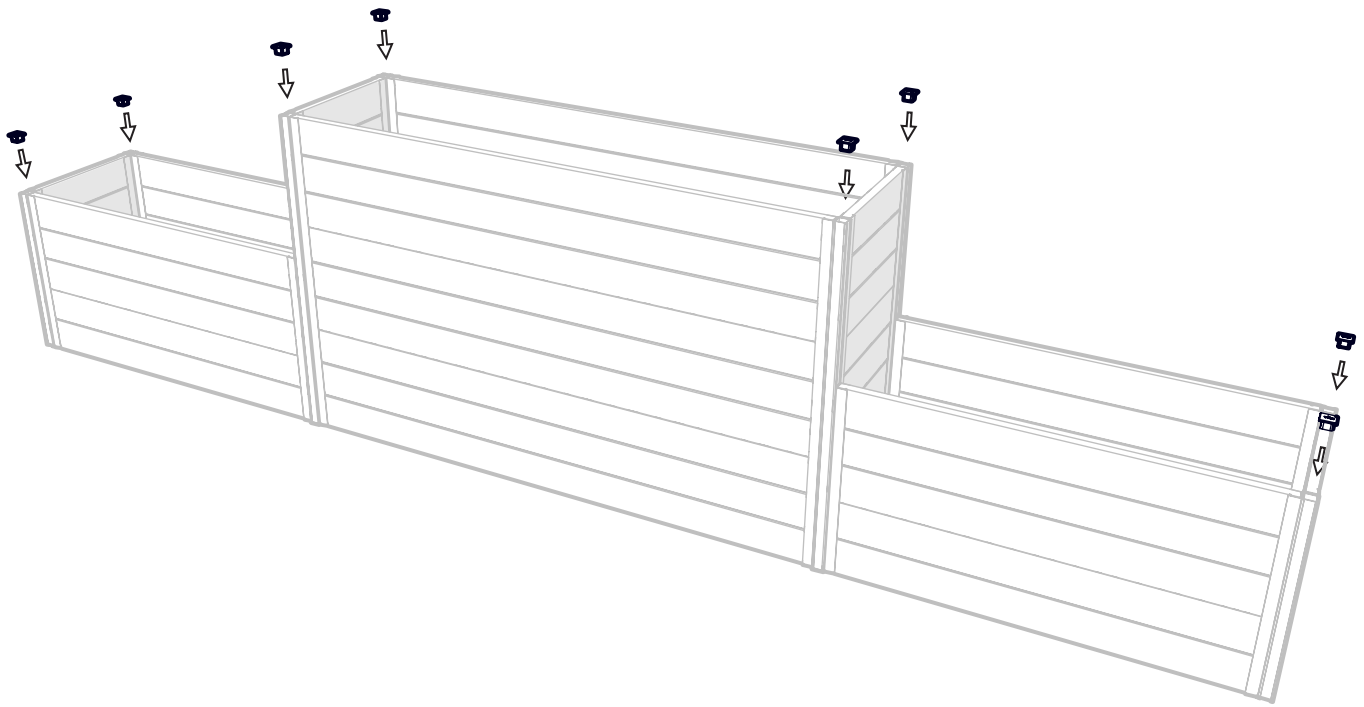

15

16024/15024 - x4

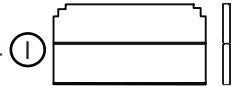

16025/15025 - x6

