

STELLA WALL SCONCE - PLUG

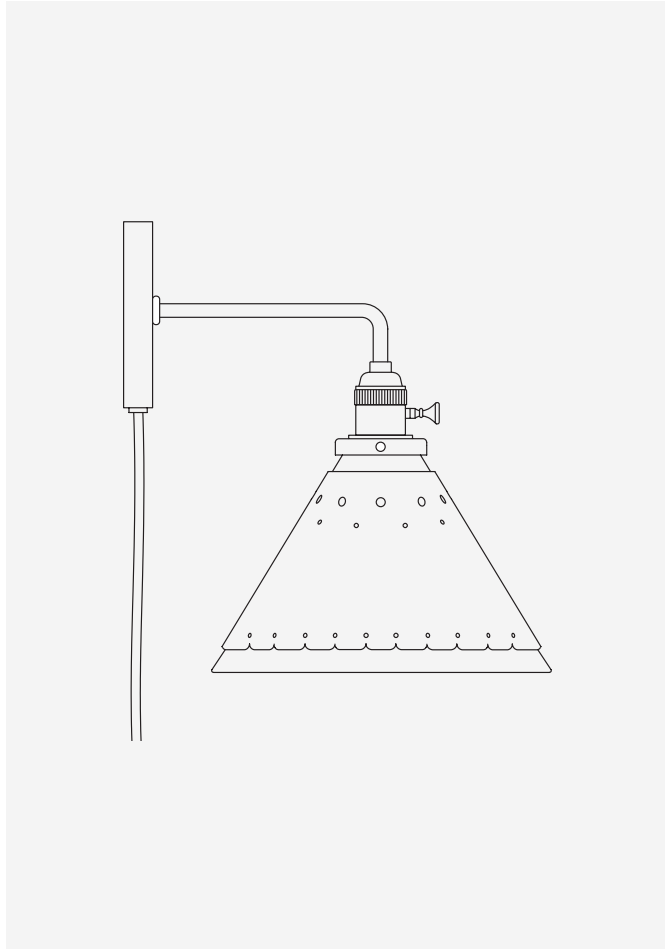







DESCRIPTION

The perforated leather sleeve simply slips over a hand-blown glass shade allowing just enough light to peek through, while effectively concealing the bulb. The arm connects to the matching circular backplate adding to its charm. The color of hand-sewn leather will gradually evolve with each year it hangs.

SPECIFICATIONS

Leather Shade

-  Cloud Blue
-  Dogwood
-  Espresso
-  Natural

Metal

-  Satin Brass

Cord

-  Brown Rayon Cord

Materials	Leather and glass shade, brass arm, brown rayon cord.
Lamping	1 x E26. 250V/250W
Bulb	To ensure lifelong performance we recommend the use of LED bulbs under 40 Watts.
Certification	Can be UL certified. Please inquire.
Product Weight (lbs)	3.10

NOTES

1. The shade and texture of the leather will vary with each item.
2. Dry location rated.
3. Made to order. Please allow 6 - 8 weeks for delivery.
4. Finish samples are available upon request.

CARE

Since each side of leather is different, the shade and texture of the leather will vary with each item.

The patina created by daily wear-and-tear is meant to change and evolve over time. Please care for your leather products with a soft cloth and a leather cleaner.

Please care for the brass pieces with a soft cloth, and avoid using any abrasive cleaners or products.

DIMENSIONS

Shade: 9" DIA x 6.5" H
 Depth: 12" D (Overall depth from wall)
 Backplate: 5.25" DIA
 Cord: 10' L

ISOMETRIC

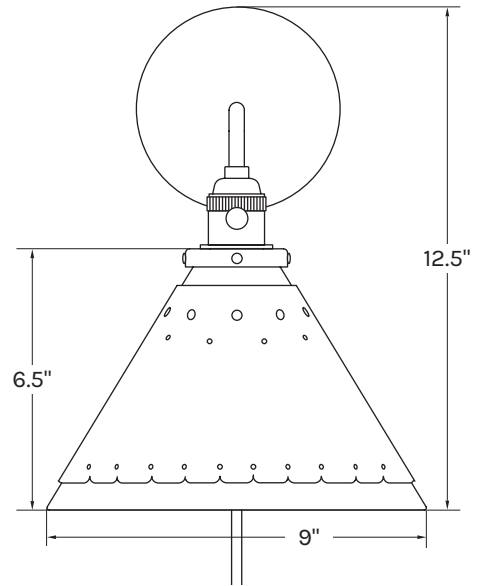

SIDE

