

NORSE MIRROR - OVAL

Installation Guide

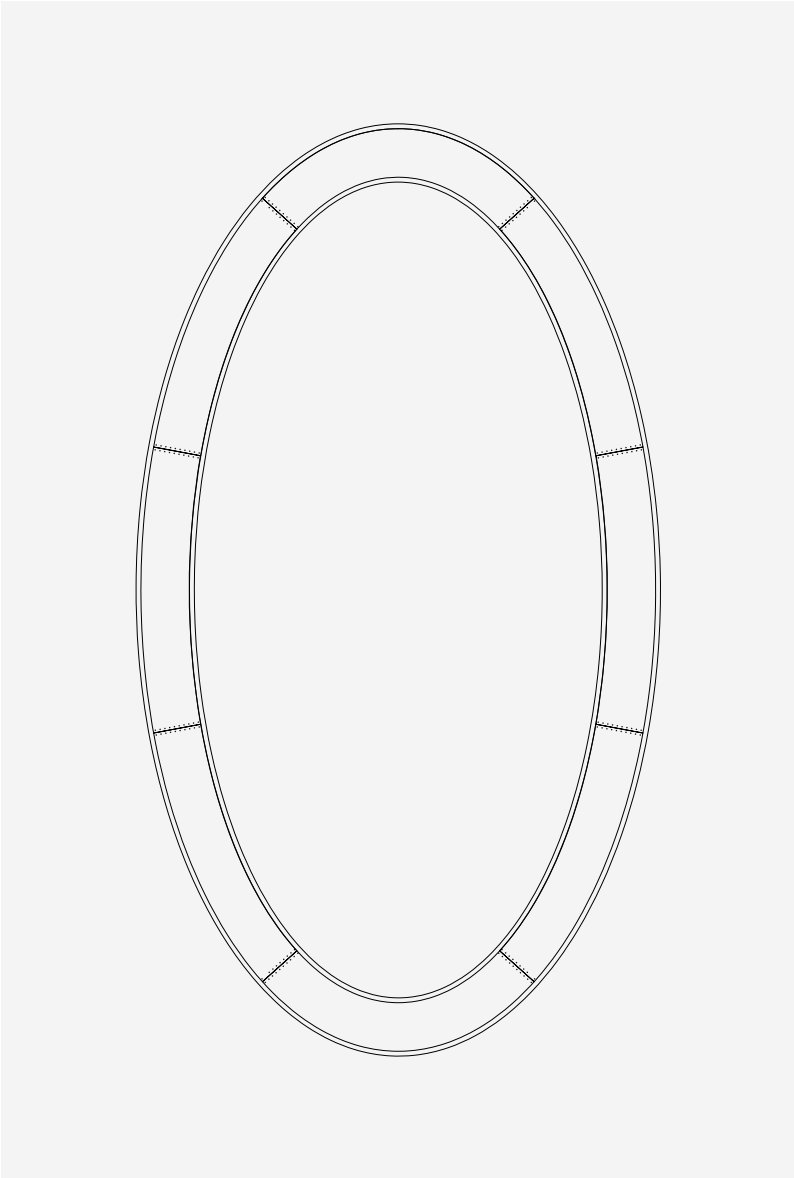

BEFORE INSTALLATION

Carefully unpack the mirror and inspect for damage. Please check that you received all of the components pictured in this guide. If anything is missing, please contact, shopkeeper@lostine.com, and one of our customer service representatives will be able to assist you.

HARDWARE

Hardware for hanging your mirror is included with your shipment. It should include one mounting cleat, four screws, and a small spirit level. The other half of the mounting bracket is already installed on the back of the mirror.

NOTE 1: The included screws for attaching the mounting cleat are intended for use in drywall only. If you are hanging the mirror on a wall not built from drywall (i.e. plaster, masonry, wood, etc), use screws and anchors appropriate for your specific surface.

NOTE 2: If you wish to change the orientation of your mirror simply remove the cleat and reattach using the pre drilled holes marked with yellow arrows on the back of your mirror.

Horizontal Orientation

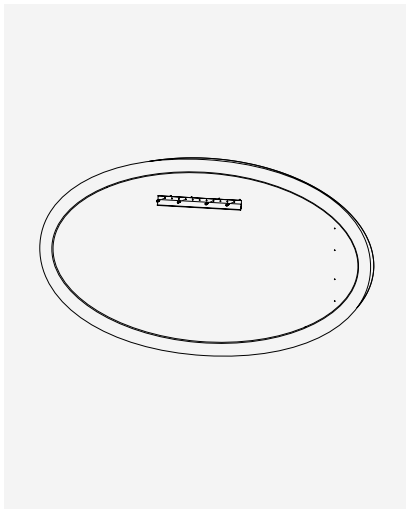

Vertical Orientation

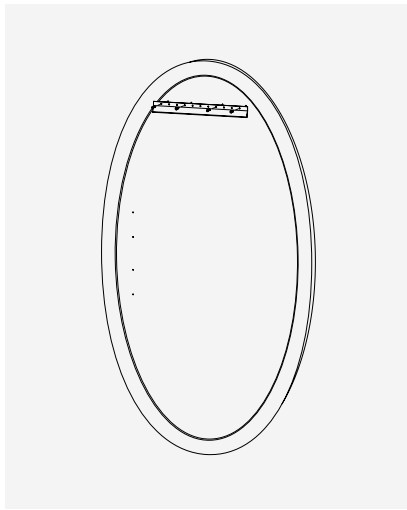

COMPONENTS INCLUDED

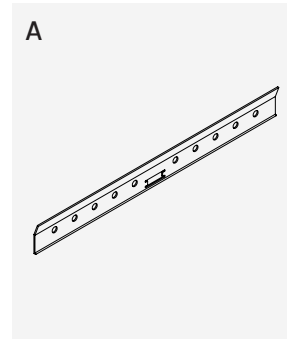

Cleat
X 1

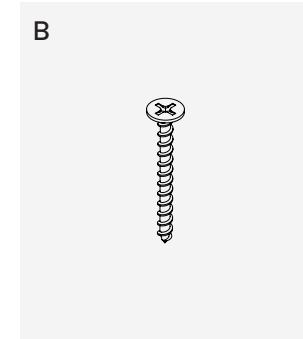

Drywall Anchor Screw
X 4

COMPONENTS NOT INCLUDED

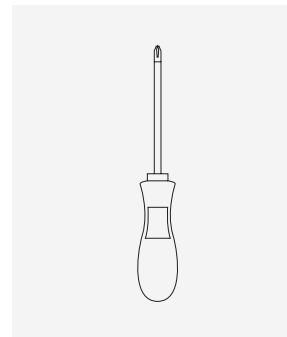

Phillips Head Screwdriver

01. Determine the exact location where you want to hang the mirror. Temporarily mark the location of the top edge of the mirror on the wall with pencil or a piece of painters tape.
02. Making sure the mirror is centered, measure straight down six inches from the marked location of the top edge and make an additional mark. This marks the location to hang the provided mounting cleat.

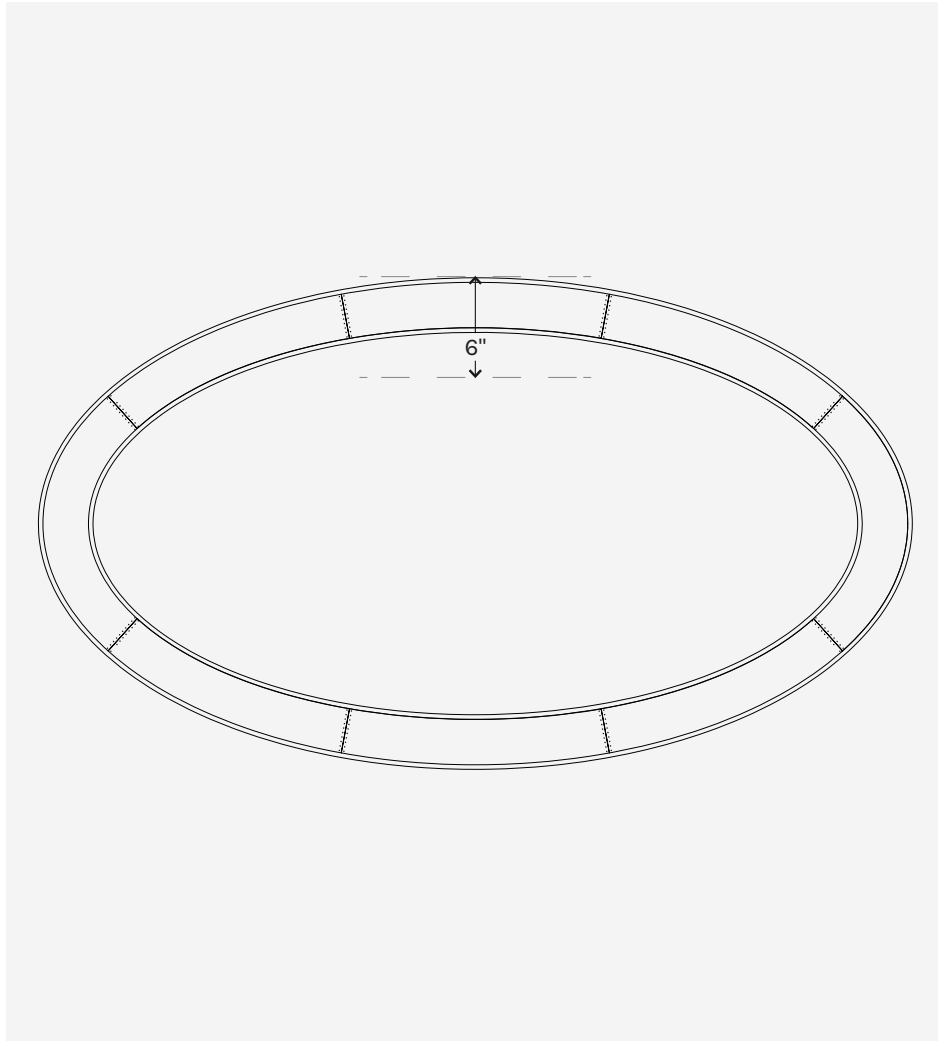

03. To attach the mounting cleat to the wall, line up the top edge of the cleat to the marked line. Use the provided spirit level to make sure the cleat is level. Make sure the cleat is oriented the proper way up with the top of the cleat bending outward from the wall.

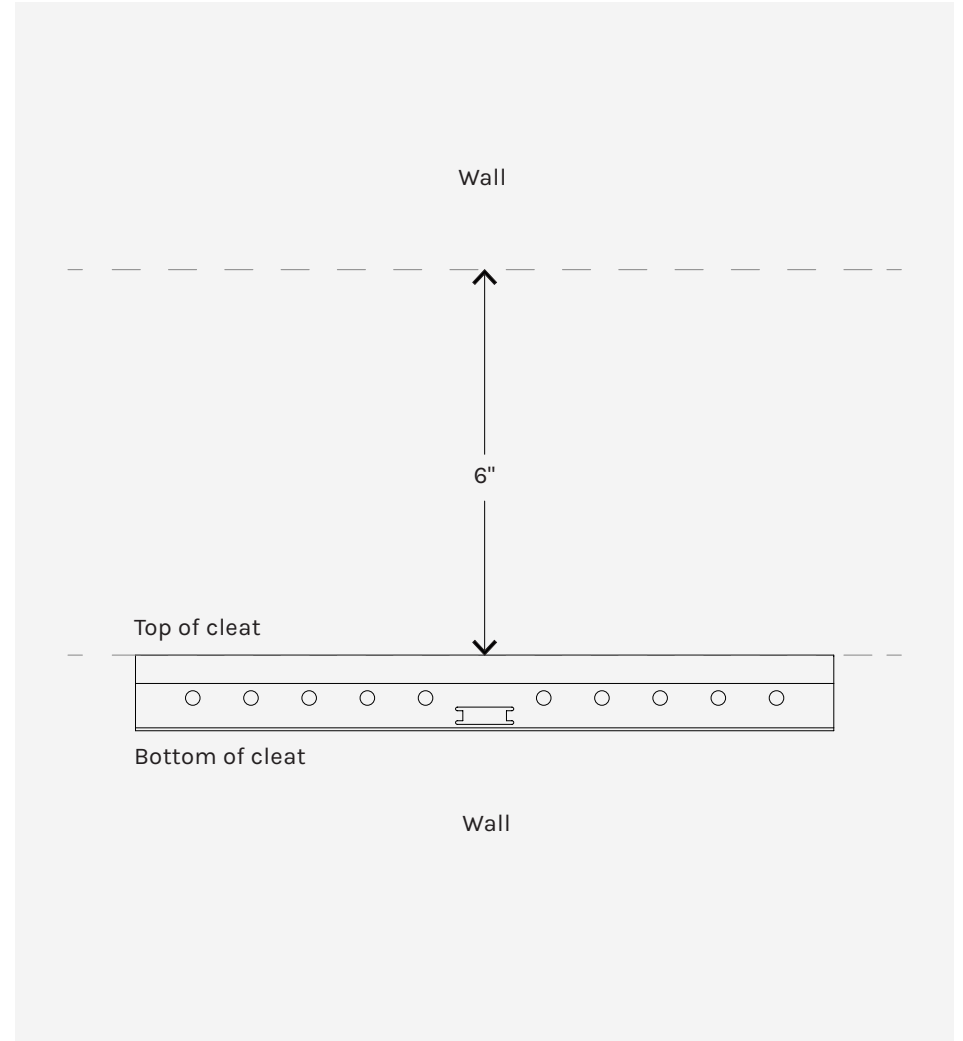

04. Screw the mounting cleat to the wall using the four provided screws (use different screws and anchors if installing onto a wall other than one built from drywall). Be careful not to overtighten.
05. After attaching the mounting cleat, double check that the cleat is firmly attached and level. It should sit flush against the wall and not wiggle.

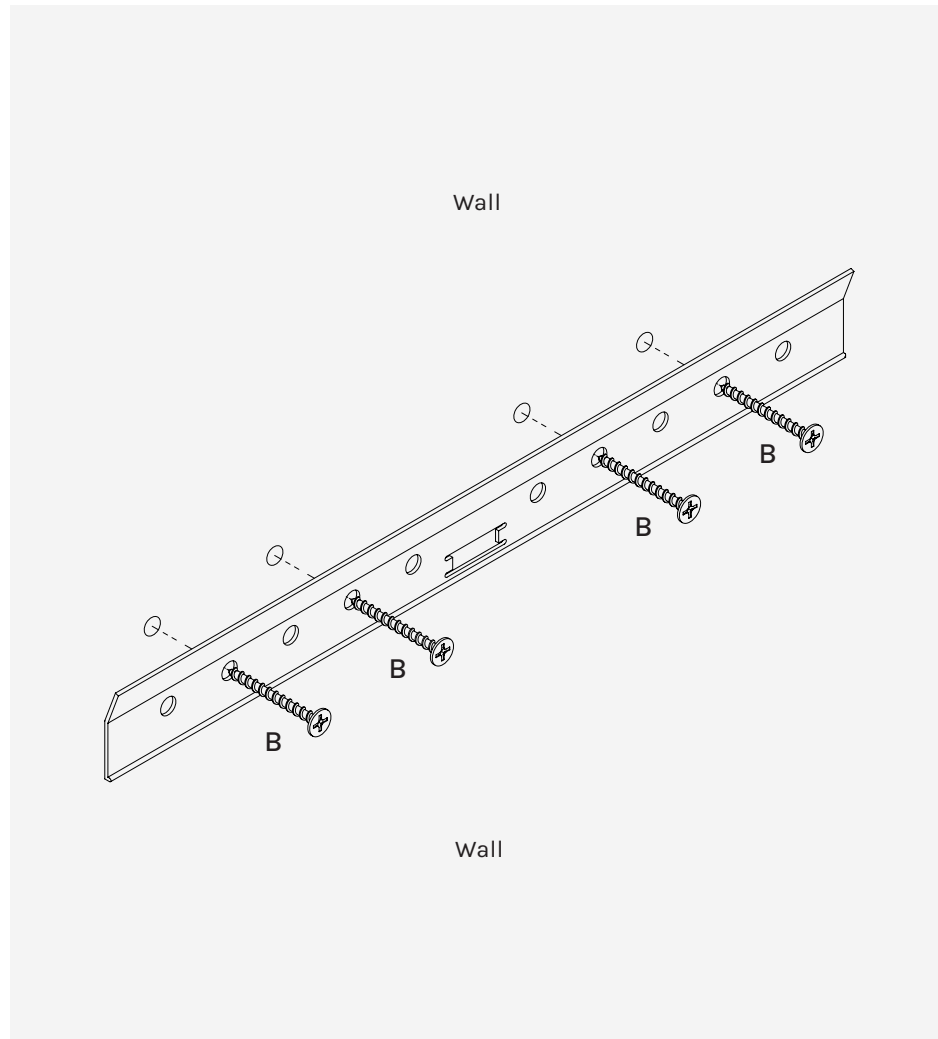

06. Lift the mirror to the wall above the mounted cleat and slowly lower it down so the clear attached to the back of the mirror locked onto the cleat attached to the wall. It should fit securely.

The cleat allows for a little movement from side to side if you need to adjust the centering; however, make sure the clear is fully supported along the length of it. If you need to adjust the centering more than an inch or so, it is recommended that you rehang and recenter the cleat on the wall.

