

FAIRMOUNT MIRROR

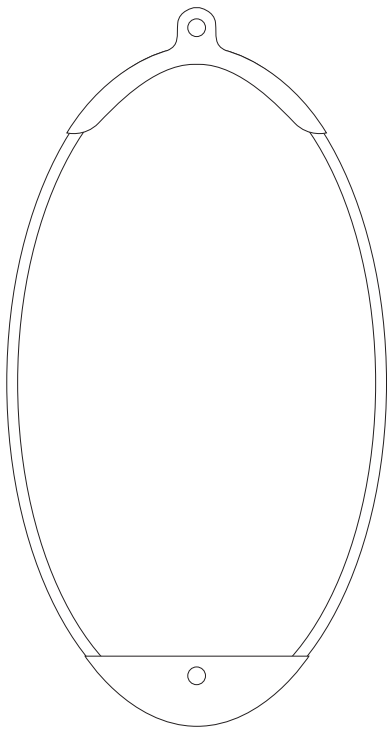

BEFORE INSTALLATION

Read through all assembly instructions once before beginning.

Two people are not required for assembly, but it is recommended.

INCLUDED

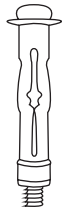

x1

Wall Anchor

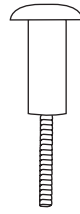

x1

Decorative Hammered Bolt

YOU'LL NEED



Phillips Head Screwdriver



7/16 Drill Bit

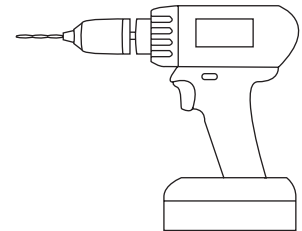

Power Drill

1. Mark out the spot where you wish to hang the mirror on your wall. (Note: the kit included with your mirror is for mounting directly into drywall, not a wooden stud).

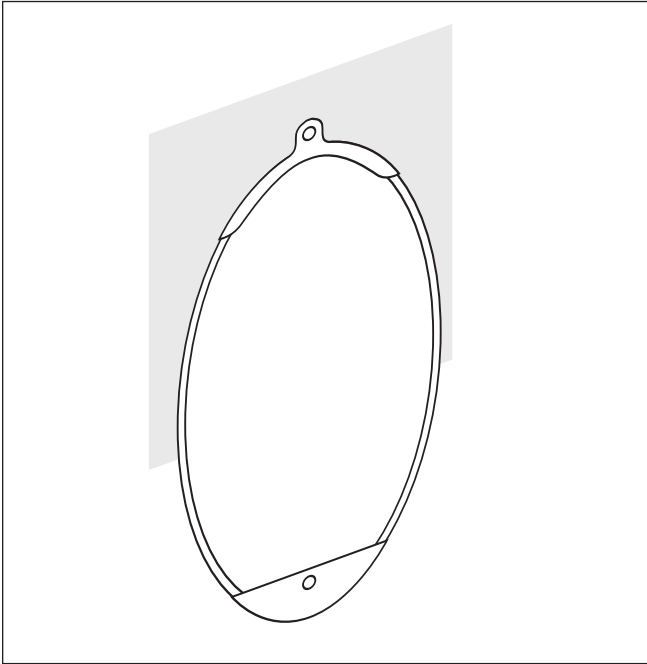

2. Drill a 7/16" hole using a 7/16" drill bit on your mark (drill bit not included).

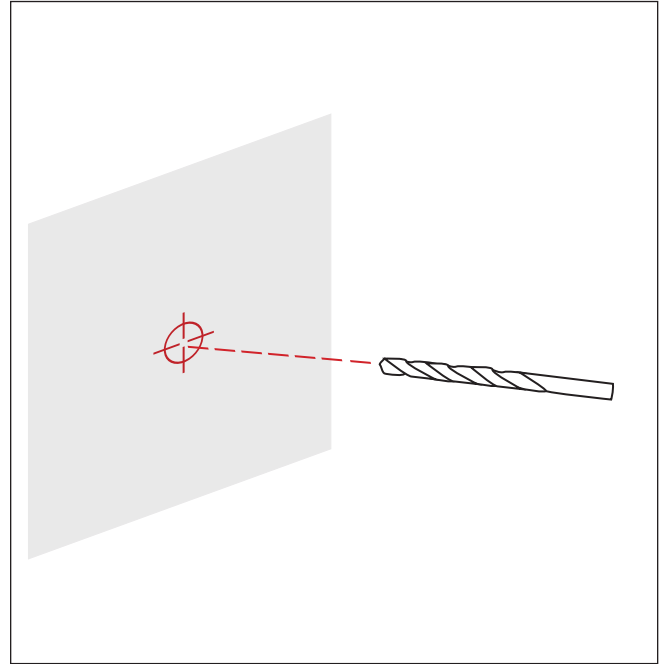

3. Gently tap the anchor into the hole (do not remove the silver bolt from the anchor, it is used to tighten the anchor into the wall).

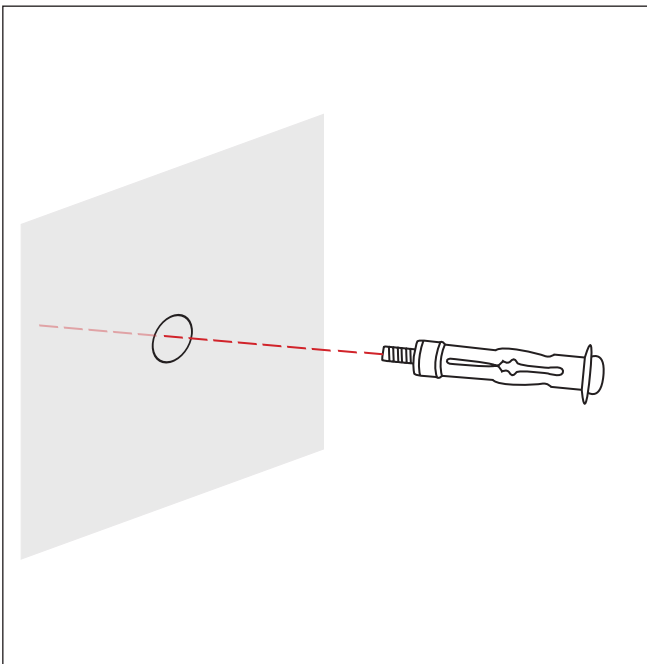

4. Once anchor is tapped in, use a phillips head screwdriver to turn the anchor's bolt clockwise until you feel resistance; this signifies that the anchor has expanded and is firmly mounted. (Note: using a power drill reduces your ability to feel when the anchor is tightened properly).

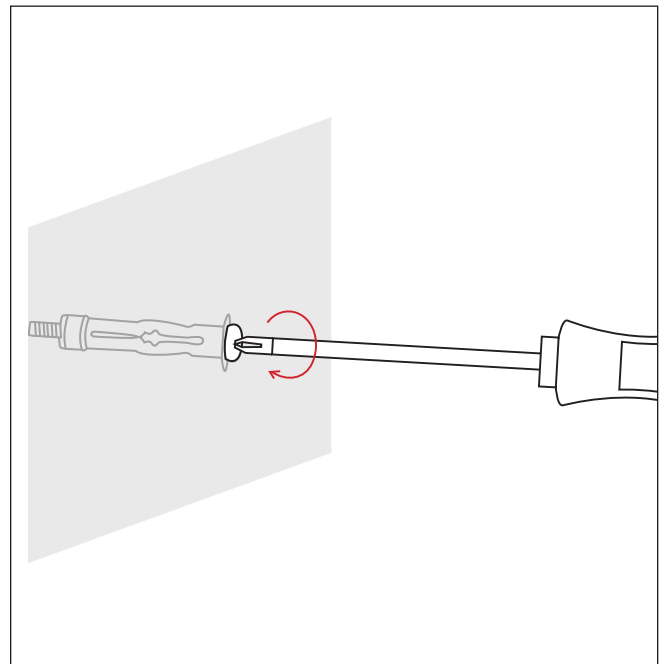

5. Line your mirror up to the anchor. Remove the anchor's silver bolt.

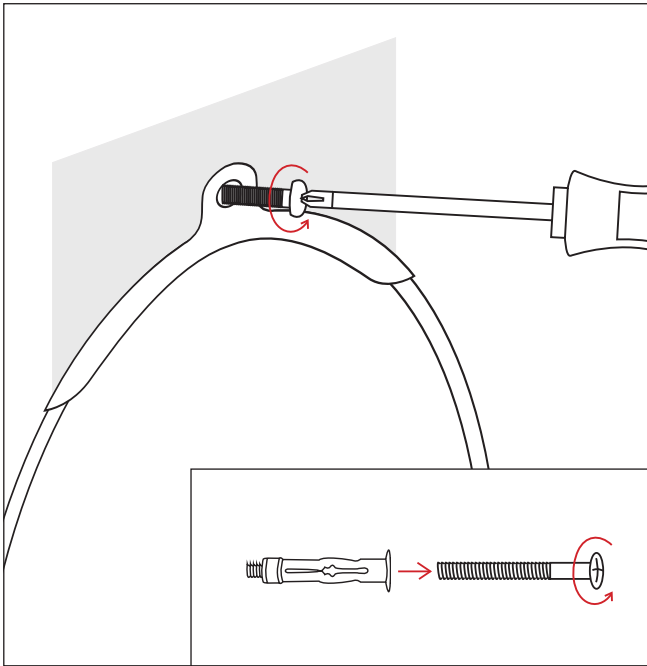

6. With the mirror placed into position, thread in the decorative hammered bolt up to the 1" collar with the leather mirror held in between.

