

ALEK WALL SCONCE

Installation Guide

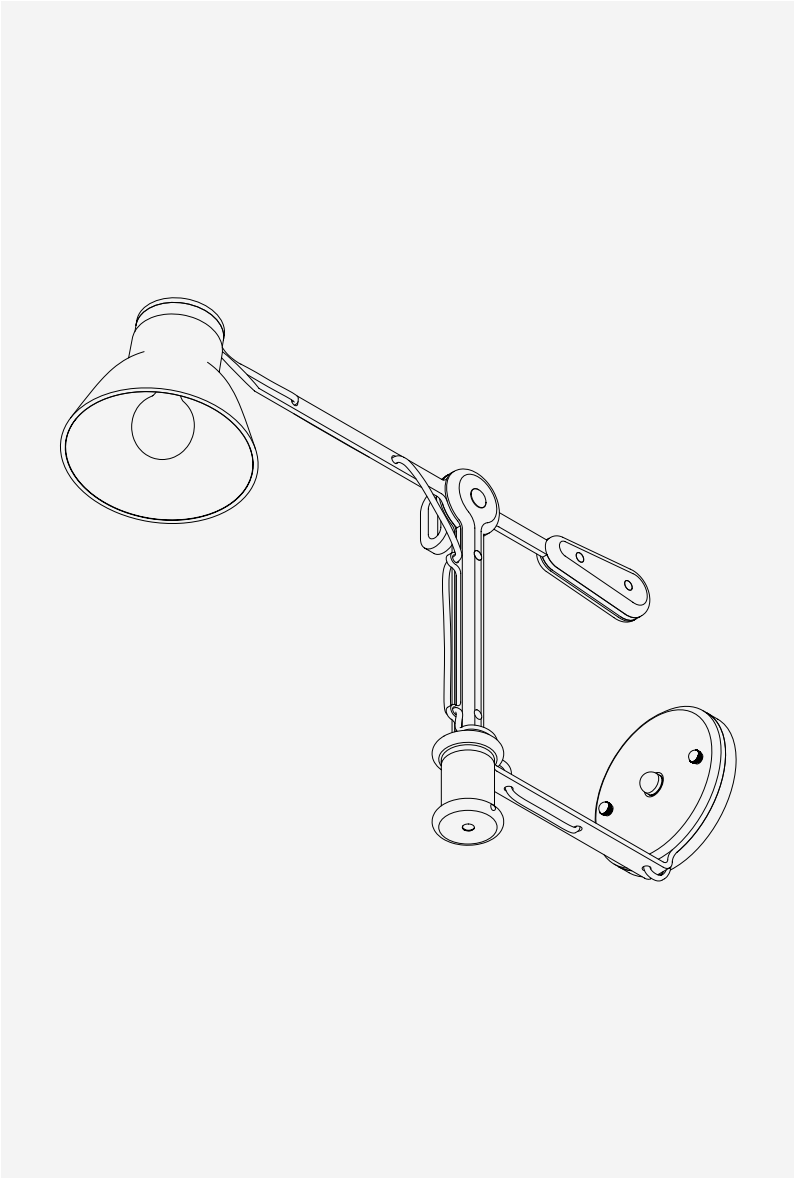



CAUTION

This product should be installed only by a licensed electrician. Turn off all electrical power at the main fuse box before installation. Turning off the power from a light switch may not be sufficient enough to prevent from electrical shock.

For your safety and for proper operation of the luminaire, read and understand all instructions completely before installation.

UNDERSTANDING THE FIXTURE

Please care for the brass pieces with a soft cloth, and avoid using any abrasive cleaners or products. The patination process will speed up if any brass product or component is excessively handled. Gloves are recommended for installation.

BEFORE INSTALLATION

Carefully unpack the luminaire and inspect for damage. Please check that you received all of the components pictured in this guide. If anything is missing, please contact, shopkeeper@lostine.com, and one of our customer service representatives will be able to assist you.

COMPONENTS INCLUDED

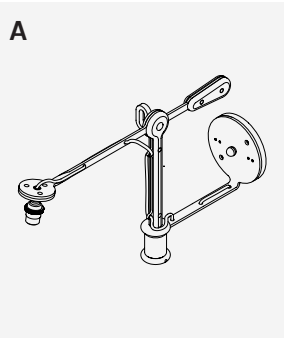

Backplate
x1

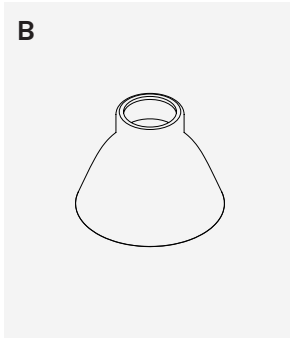

Ceramic Shade
x1

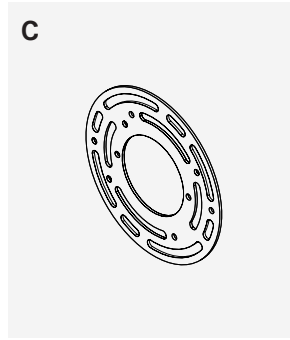

Crossbar
x1

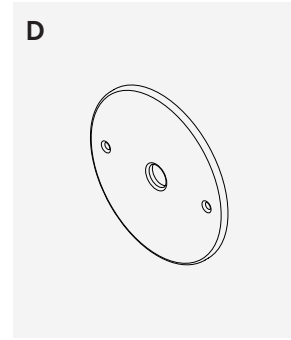

Ceramic Cover Plate
x1

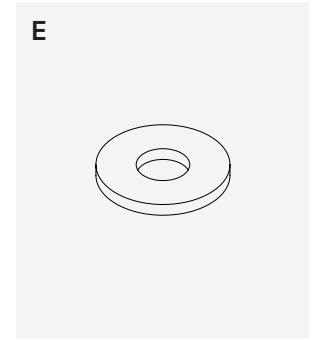

Leather Washer
x1

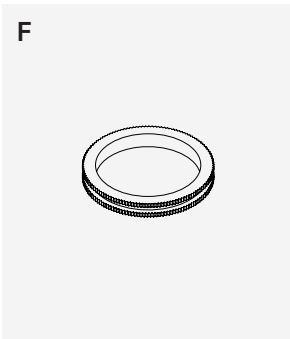

Knurled Captive Ring
x1

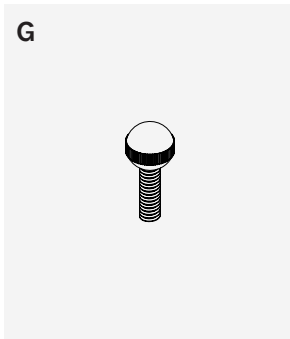

8-32 Brass Ball Screw
x2

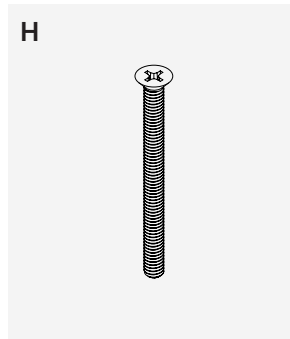

2" x 8-32 Steel Screw
x2



Large Plastic Wire Nut
x2

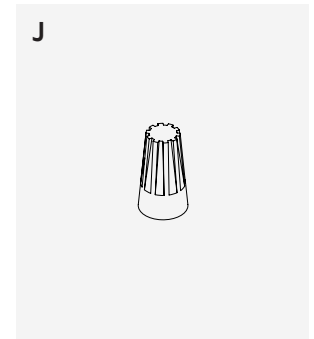

Small Plastic Wire Nut
x1

COMPONENTS NOT INCLUDED

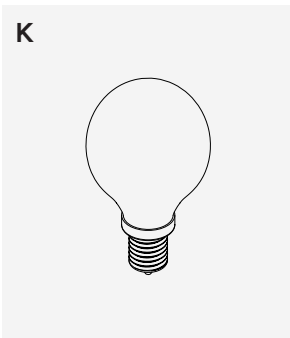

E 12 Bulb
x1

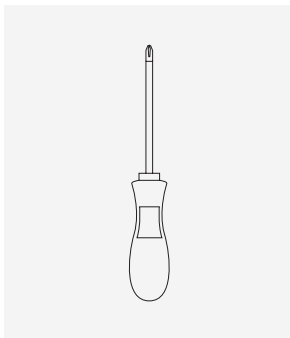

Phillips Head Screwdriver
x1

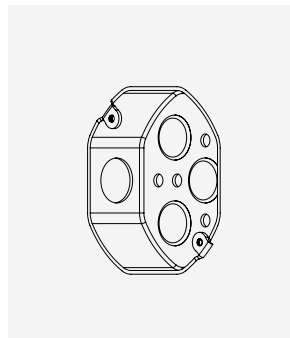

Junction Box
x1

WIRING

1. WARNING

Shut off the power to the electrical box. Turning off the power from a light switch may not be sufficient to prevent electrical shock.

2. Connect the Crossbar (C) to the electrical box, positioning the 3.5" mounting holes diagonally to align with the Steel Backplate (A).
3. Following the electrical configuration listed below, connect the wires from the luminaire to the electrical box using the provided Plastic Wire Nuts (I) and (J).

From Electrical Box	From Luminaire
Connect Black or Red (HOT) wire from supply to:	Black Wire
Connect White (NEUTRAL) wire from supply to:	White Wire
Secure Green or Bare Copper (GROUND) wire from supply to the green screw on the Crossbar (C).	

4. Attach sconce to the electrical box using provided Steel Screws (H).
5. Place Ceramic Cover Plate (D) over Steel Backplate (A) and secure with the provided 8-32 Brass Ball Screws (G).

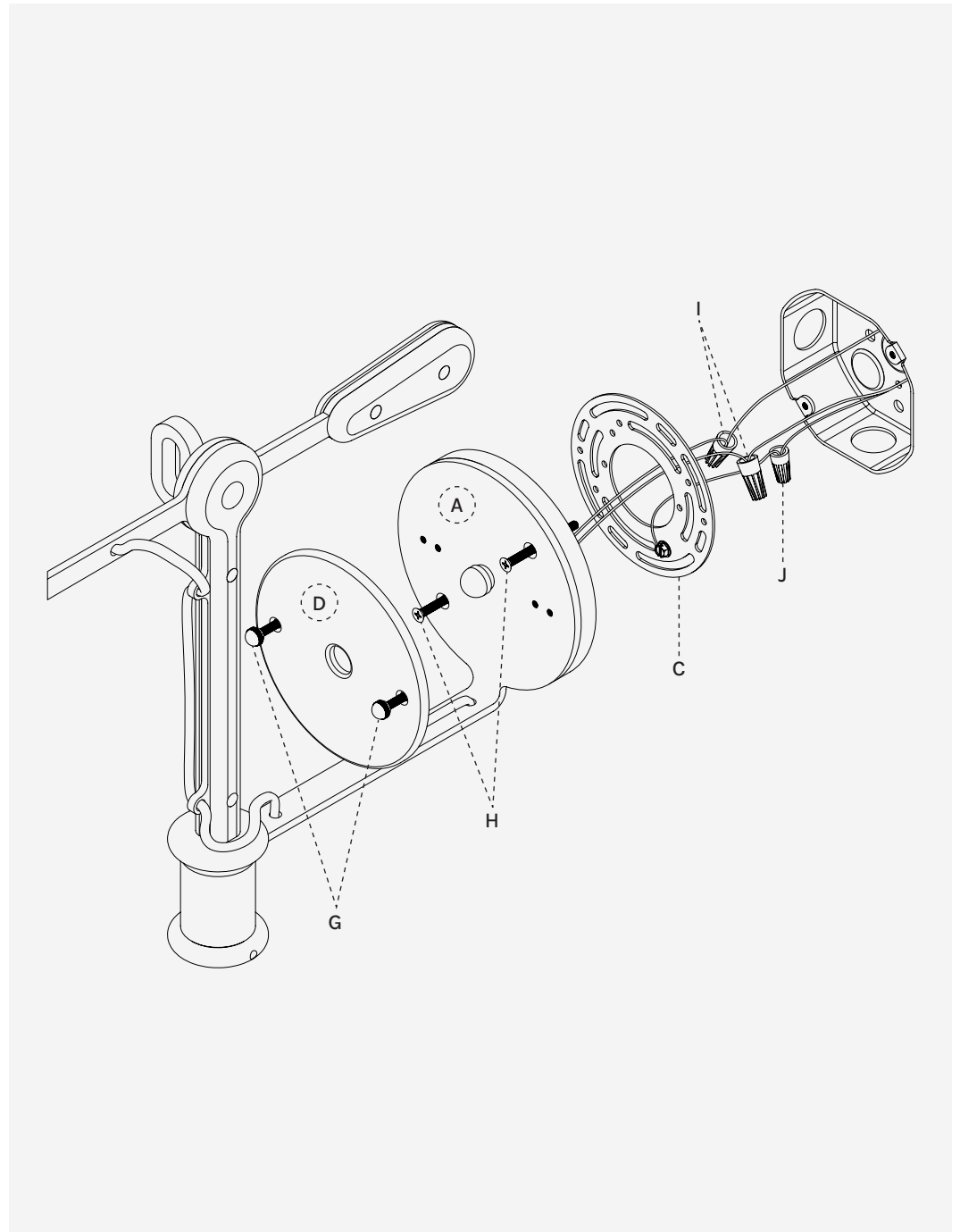

SHADE ASSEMBLY

1. Place the Ceramic Shade (B) onto the socket arm. Hold in place, and assemble the Leather Washer (E) onto the Socket (A), then secure using the Knurled Captive Ring (F).
2. Place the Light Bulb (K) into the Socket-Shade Assembly (A).
3. Turn the power back on to the electrical box and enjoy your luminaire.

