

REV SPEED METER

RSM *REV/SPEED METER*

Instruction Manual

Thank you for purchasing this unit. Please read this manual to ensure proper use of this product. Also, be sure to keep this manual in a safe place for future reference. Be sure to include this instruction manual when transferring ownership of this product.

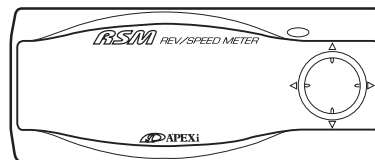

Product Name	REV / SPEED METER
Product Code	405-A912 / 405-A916
Applications	Only for Vehicles listed in the Wiring Diagram Booklet
Features	Engine Speed and RPM, Travel Distance Battery Voltage 0-100,200,400m Acceleration 0-100,200,300km/h Acceleration Preset 0-250km/h Mid-Range Accel., etc.

Contents

Chapter 1 To Begin	
Safety Precautions	4
Functions	6
Part Names and Functions	8
Parts List	8
Part Names	9
Glossary	9
About the Optional Parts	10
Chapter 2 Initial Setting	
Before Using this Product	12
Initial Setting Table	13
Flow of Initial Setting	13
About a part of Nissan car and the HONDA car	14
Other initial Settings	15
Tire Size Correction 【TIRE】	15
Vehicle Weight input 【WGHT】	15
G Sensor Calibration 【Gsnsr Corr】	15
Using Optional Outputs	16
RPM Output 【RvO】	16
Vehicle Speed Output 【SpO】	16
Using the Warning Display	17
RPM Warning Display 【RvW】	17
Vehicle Speed Warning Display 【SpW】	17
Chapter 3 Operation	
Function and Operation	20
Monitor Mode Overview	22
Measure Mode Overview	23
Etc. Mode Settings	23
Chapter 4 Monitor Mode 【Monitor】	
Choosing between 1~4 Channels 【1Channel】 ~ 【4Channel】	26
Graph Mode plotting RPM as Horizontal Axis 【Rev.-【Y】】	30
Graph Mode plotting Front/Rear/Left/Right Acceleration 【G-FR/RL】	31
Chapter 5 Measure Mode 【Measure】	
0-100,200,400m Acceleration 【0-＊00m】	34
0-100,200,300km/h Acceleration 【0-＊00k】	36
Preset Mid Range Acceleration 【＊＊-＊＊k】	38
Stop Watch Measurement 【STOP-W】	40
Power Measurement POWER】	42
Loss Power Input/M Measurement 【LOSS-P】	43
Chapter 6 Etc Mode 【Etc】	
Output Setting 【Output set】	48
Graph Scale Setting 【Grph Scale】	49
Vehicle Specific Setting 【Car Select】	50
VFD Adjustment 【VFD Bright】	51
G Sensor Calibration 【Gsnsr Corr】	52
Initialize All Data 【Initialize】	53
Troubleshooting	54

Chapter 1

To Begin





Safety Precautions	4
Product Features	6
Part Names and Functions	8
Parts List	8
Part Names	9
Glossary	9
About the Optional Parts	10

Safety Precautions

For safe use of this product, be sure to read the Safety Precautions. Keep the manual in a safe place after use for future reference. We have included these warnings to protect the user and dealer from unnecessary harm. These points have been marked throughout this manual by SIGNAL WORDS. Please refer to the table on the left for a glossary of terms

■ Glossary

Display	Meanings
 WARNING	Failure to do so may result in death or severe injury to the user and others.
 CAUTION	Failure to do so may result in light injury to the user and others or product and engine damage.
PLEASE	Failure to do so may result in product malfunction and damage.

WARNING

● **Never use this product on a vehicle that is NOT listed in the manual.**

We cannot and will not guarantee proper operation of the unit and vehicle. Also, this may lead to severe accidents and should be avoided.

● **Discontinue use of this product immediately if any unusual odor or smoke comes from the unit.**

Failure to do so may result in electrical shorts and potential engine fire. Kindly repack ALL the components of this unit in its original packaging and return to your dealer of purchase with the original receipt

● **Do not use this product for any other purpose than the one listed in this manual.**

We are not responsible for any damages or injuries incurred from improper usage of this product.

● **Do not rapidly turn the Ignition key ON and OFF.**

This may erase the data and settings in the unit.

 **WARNING**

● **Never operate this unit while driving**

This may lead to accidents.

● **Always remove the negative terminal of the battery before attempting installation.**

Failure to do so may result in electrical fires and engine fire.

● **Never pull hard on the coupler, be sure to correctly unclip the coupler.**

Failure to do so may result in loose wire electrical shorts and electrical fire.

● **Always wire the unit up according to the instruction manual.**

Failure to do so may result in electrical fire, improper unit / vehicle operation.

● **If adjustments are necessary during driving, be sure to slow down and abide by all the rules and regulations of the highway before adjusting.**

Failure to do so may result in accidents.

● **Never use the speed limiter function on public highways**

Release the speed limiter on closed race tracks only

Be sure to slow down and abide by all the rules and regulations of the highway.

 **CAUTION**

● **This product should ONLY be installed by a trained professional installer.**

Installation requires past experience to prevent damage to the unit and vehicle. We will not honor any claims arising from improper installation of this unit.

● **Never disassemble or tamper with this unit.**

This could lead to serious injury.

● **Do not expose this unit to excessive shock.**

This could lead to unit malfunction.

● **Do not use this under extremely high temperatures or under direct sunlight.**

Failure to do so may lead to improper unit operation and vehicle damage.

● **Keep this unit away from direct sunlight and direct water.**

Failure to do so may lead to electrical shorts and unit damage.

FUNCTIONS

The RSM (Rev Speed Meter) is a multi function measuring device designed to measure and monitor vehicle speed, RPM, 0-400m time, mid range acceleration, estimated horsepower, as well as acceleration G.(Using optional G Sensor)

■ Easy to Read VFD (Vacuum Fluorescent Display)

The RSM utilizes an easy to read VFD screen in a highly stylish case which also complements the cockpit interior.

Due to the 3 row 7 segment LED screen used on the previous model, we were only able to display a limited amount of information on screen. Now with the new dot matrix VFD screen, we are able to display multiple types of data in multiple formats. In addition, we are also able to display the data in graph mode, and analog modes to ensure that the driver is properly informed.

■ Thin Case/ Single Button Design

Circuit board and case design have been engineered to fit into a highly compact 52mm x 126mm x 18mm space. This allows easy mounting on the steering column and dashboard. Since the unit is self contained, there is no need to search for room to mount a control box. By using a single button design, we have also maximized efficiency when navigating through the menus.

■ Allows Speed Limiter Cut for a variety of Applications

Compatible with new style HONDA speed limiters.

■ Retains MEMORY settings even with the battery disconnected

By utilizing an EEPROM, the unit will not lose its memory settings even if the battery is disconnected, or the power is turned OFF. Of course, the best 5 Time Measurements are also constantly stored. This eliminates the necessity of reprogramming the unit every time after routine services.

Please

- The wiring harness of this unit may cause some electrical noise for some TV and radio applications. Please avoid passing the wiring harness near these products.
- The heat generated by this unit is normal.

■ Various Measurements/ Display Parameters and Best Time Recording

Engine RPM, Speed, Travel Distance, and Battery Voltage can be displayed in real time Graph Mode. Numerical Mode and Meter Mode allows Peak Hold function while the Graph Mode allows for Replay. In addition, the unit can measure Travel Distances, 0-100m/200m/400m times and 0-100km/h/200km/h/300km/h times. Also, in the Mid Range Acceleration Mode, the user can preset any range of speed to measure. The Top 5 times will be stored in the memory until initialized. (The stop-watch function will reset when the power is turned OFF)

■ Outputs for Engine RPM and Vehicle Speed to Activate External Relays

This unit has outputs for engine RPM and vehicle speed that are activated when the vehicle exceeds the preset values. For example, a separate radar detector can be made to turn ON at a certain speed, or an external shift light can be made to turn ON after a certain RPM. Also, a scramble boost switch can be connected to the output to activate it at a certain RPM. The possibilities are limitless.

■ Using the Optional G Sensor allows measurement of Front/Rear/ Left/Right Acceleration

Using the separately sold G Sensor allows the unit to measure G's in 4-way front/rear/left/right directions. This data can also be plot onto a graph display. Replay function is standard. This feature can be used to map acceleration characteristics on the race track.

■ Using the Optional G Sensor allows Horsepower Calculation

The Highly popular Apex Power Meter is integrated into this unit. By inputting total vehicle weight and resistance during actual driving (Lost HP is measured at certain speed increments) the unit can measure HP through the speed sensor signal.

■ Using the Optional G Sensor : 0-400m Wheel-spin correction

The unit calculates and compensates the distance of wheel-spin for accurate measurements

 **CAUTION**







● **Never use the speed limiter function on public highways**

Release the speed limiter on closed race tracks only
Be sure to slow down and abide by all the rules and regulations of the highway.

Part Names and Functions

■ Parts List

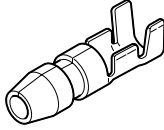
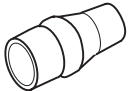
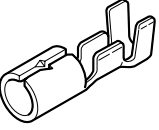
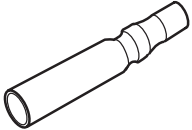

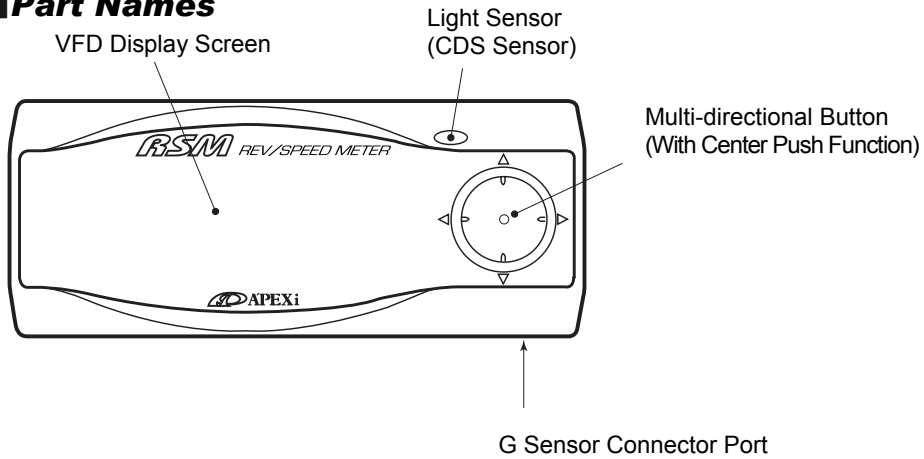

Be sure to check the contents before attempting installation. Please notify your dealer of purchase for any missing or broken parts BEFORE attempting installation.

1. Control Unit	2. Instruction Manual	3. Wiring Manual	4. Diagram
			
1	1 (This book)	1	1
5. Signal Harness	6. Male Fitting	7. Male Sleeve	8. Female Fitting
			
1	4	4	4
9. Female Sleeve	10. Splice		
			
4	4		

Part Names



How to Operate Main Button Switch

-  Push UP
-  Push DOWN
-  Push LEFT
-  Push RIGHT
-  Push CENTER

About the Pop-Up Menus

When the Center Button is depressed, the Pop Up Menus to the right will appear on screen. Use the button to illuminate the desired parameter and push the Center Button to select.

Ex)  Press the Center Button, and select Nx from the Pop Up Menu.



GLOSSARY

- T p [TOP] Return to the Main Menu
- N x [NEXT] Proceed to Next
- P r [PREVIOUS] . Return to Previous
- C n [CANCEL] . . . Cancel Pop Up Menu
- R c [RECORD] . . Record

About the Optional Parts

■ **G Sensor for Accurate Power Readings**

By utilizing the optional G Sensor, the user can monitor 4-way G movement as well as highly accurate power measurements. Usually, when measuring 0-400m times through the speed sensor signal alone, the meter will end measurement too early (shorter distance) due to wheel-spin. Using the G Sensor will compensate for the wheel-spin and give an accurate reading of acceleration times.



G-SENSOR
Product Code
430-A013

■ **Convenient Mounting Bracket**

Many dashboards these days have curved surfaces making mounting a problem. This bracket allows the unit to be mounted securely almost anywhere on the dash. Flexible angle adjustment allows maximum visibility.

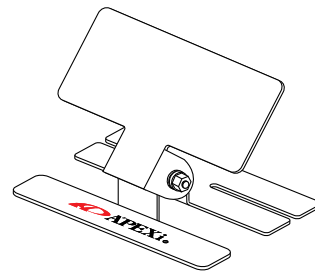

Mounting Bracket
Product Code
430-A006

WARNING

● **Never use the speed limiter function on public highways**

Release the speed limiter on closed race tracks only.
Be sure to slow down and abide by all the rules and regulations of the highway.

Chapter 2 Initial Settings

Before Using this Product	12
Initial Setting Table	13
Flow of Initial Setting	13
About a part of Nissan car and the HONDA car	14
Other Initial Settings	15
Tire Size Correction 【TIRE】	15
Vehicle Weight Input 【WGHT】	15
G Sensor Calibration 【Gsnsr Corr】	15
Using Optional Outputs	16
RPM Output 【RvO】	16
Vehicle Speed Output 【SpO】	16
Using the Warning Display	17
RPM Warning Display 【RvW】	17
Vehicle Speed Warning Display 【SpW】	17

Before Using this Product

1 Install the unit

Please refer to the separate Vehicle Specific Wiring Diagram Booklet for proper installation on the vehicle.

- Be sure that your vehicle is listed in the wiring diagrams. Do NOT install on any vehicle not listed in the wiring diagram booklet.

2 Perform Initial Setting

In order to properly use this unit, a few initial parameters must be set.

① Initial Settings

Initial Setting Table

Flow of Initial Setting	P13
About a part of Nissan car and the HONDA car	P14

② Other Settings that may be necessary

When changing Tire diameter

Tire Diameter Correction	P15
--------------------------------	-----

Using Outputs

Engine RPM Output	P16
Vehicle Speed Output	P16

Using the Warning Display

Engine RPM Warning Display	P17
Vehicle Speed Warning Display	P17

When using the Optional G Sensor (sold separately)

G Sensor Calibration	P15
----------------------------	-----

When Measuring Power Levels

Loss Power Input	P43
Vehicle Weight Input (Necessary when measuring power and loss power using the G Sensor)	P15

WARNING

● **Never use the speed limiter function on public highways**

- Release the speed limiter on closed race tracks only
- Be sure to slow down and abide by all the rules and regulations of the highway

Initial Setting

To next page



Flow of Initial Setting

It initializes it as follows before this product is used.

Please note that the setting is different in a part of Nissan Motor car and the HONDA car.

Please refer to the setting of P50 according to the model for the operation method.

1	Cylinder Number Setting	P50 [etc.] → [Car Select] Cyl
↓	Rotary Engine	# of Rotors x 2
	Other	Cylinder Number
	Some TOYOTA engine RPM numbers may be displayed 1/2, and 1/3 depending upon the ignition firing types. In these, In those cases, set the cylinder setting to 1/2 or 1/3 and match the display to the actual RPM.	
2	Speed Signal Pulse Setting	P50 [etc.] → [Car Select] SP1
↓	NISSAN models	2P
	Other Japanese models	4P
	※Please refer to P14 for the pulse setting of a part of Nissan car and the HONDA car.	
3	Speed Pulse Adjust Setting	P50 [etc.] → [Car Select] ADJ
↓	Please set only the HONDA car of the description to P14. Other models set and are unnecessary.	
4	Speed Limiter Cut Setting	P50 [etc.] → [Output Set] SLC
	(When cutting Speed Limiter)	Standard Vehicles 170km/h Light Vehicles 130km/h
	(When retaining Speed Limiter)	OFF

Initial
Settings



WARNING

● **Never use the speed limiter function on public highways**

Release the speed limiter on closed race tracks only

Be sure to slow down and abide by all the rules and regulations of the highway



Continuation from last page

About a part of Nissan car and the HONDA car

In Nissan and the HONDA car of the following table correspondence, it refers to a table, and the pulse setting and the pulse adjustment setting of initialization are done.

■ A part of Nissan car

Name	Type	E/G Type	Year	Pulse Setting	Notes
Wingroad	Y11	QG15DE/QG18DE	'99.5~'02.7	8	
Cedric/Gloria	Y32	VG30DET	'91.8~'96.5	16	
	Y34	VQ30DD/VQ30DET	'01.12~'04.10	8	CVT Car
	Y34	VQ25DD/VQ30DD/VQ30DET	'99.6~'01.11	8	
Cima	FGY32	VH41DE	'91.8~'96.5	16	
	FPY32	VG30DET	'93.9~'96.5	16	
Cefiro	A33	VQ20DE/VQ25DD	'98.12~'00.12	8	
Bluebird	EU14	SR18DE	'96.1~'98.8	8	
Bluebird Sylphy	G10	QR20DD	'00.8~'05.11	8	
laurel	HC35	RB20DE	'98.9~'02.12	8	

■ A part of HONDA car

Name	Type	E/G Type	Year	Pulse Setting	Adj Setting	Notes
S2000	AP1	F20C	'99.4~'05.10	160	106	
Torneo	CF3	F18B	'97.9~'00.5	160	91	A/T
	CF4	F20B		160	80	A/T
Accord	CF3	F18B	'97.9~'00.5	160	91	A/T
	CF4	F20B		160	80	A/T
Accord Wagon	CF6	F20B	'97.10~'02.10	160	93	
	CF7			160	96	
Odyssey	RA6	F23A	'99.12~'03.9	160	89	
	RA7			160	86	
	RA3·4		'97.10~'99.11	160	87	
Fit	GD3·4	L15A	'02.9~'07.9	160	81	CVT
	GD2	L13A	'01.7~'07.9	160		
	GD1		'01.6~'07.9	160		
Fit Aria	GD8·9	L15A	'02.12~※	160	81	
	GD6·7	L13A		160		



WARNING

● **Never use the speed limiter function on public highways**

Release the speed limiter on closed race tracks only

Be sure to slow down and abide by all the rules and regulations of the highway

Other Initial Settings

For use when the factory tire sizes are changed

Tire Size Diameter Corr. P50 [etc.] → [Car Select] TIRE

```
car sel.
Cyl: 6
SP1: 4P
ADJ: 100%
TIRE: 103%
WGHT: 1500kg
```

Formula

$$\text{Correction Value} = \frac{\text{New Tire Diameter}}{\text{Factory Tire Diameter}} \times 100$$

Please refer to tire manufacturer data for diameter specs, or measure the tire

Ex) Skyline GT-R (BNR32)

Factory Tire	225/50 R16	Diameter 632mm
New Tire	245/45 R17	Diameter 652mm

$$\text{Correction Value} = \frac{652\text{mm}}{632\text{mm}} \times 100 \doteq 103 \quad \text{Input 103(\%)} \quad \text{Correction Value}$$

When measuring Power and Loss Power using the G Sensor (separately sold)

Vehicle Weight Input P50 [etc.] → [Car Select] WGHT

```
car sel.
Cyl: 6
SP1: 4P
ADJ: 100%
TIRE: 100%
WGHT: 1750kg
```

Formula

Vehicle Weight = Manufacturer claimed weight + Driver weight + cargo weight +(20~30)

The 20~30kg compensates for various weight differences due to optional equipment or accessories. Please account for other items in the vehicle that could affect vehicle weight.

Ex)

If the Manufacturer claimed weight is 1600kg, Driver is 60kg, and Gasoline is 70L with no extra cargo, then

$$1600 + 60 + 70 + (20 \sim 30) \doteq 1750\text{kg}$$

Input 1750(kg)

When using the Optional G Sensor (Separately Sold)

G Sensor Calibration P52 [etc.] → [Gsnsr Corr]

Always calibrate the G Sensor when installing or relocating

Using Outputs

Activate Outputs at Desired RPM Levels

RPM Output

P48 [etc.] → [Output Set] RvO

output

RvO: 7500 RPM
 SpO: 60 km/h
 RvW: 5000 RPM
 SpW: 100 km/h
 SLC: 170 km/h

This function allows an open collector transistor to turn ON when RPM exceeds a preset value.

[Default Value] 3000rpm (MAX 12V. 200mA)

Ex) If the RPM output is set to 7500rpm, the lamp will illuminate when rpm exceeds 7500rpm.

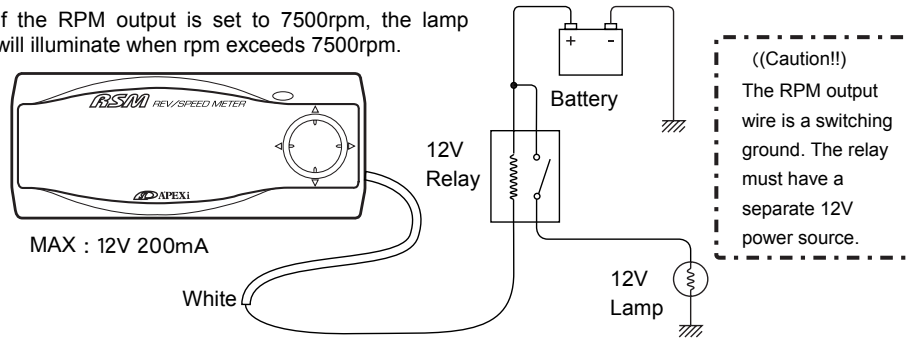

Activate Outputs at Desired Vehicle Speed

Speed output

P48 [etc.] → [Output Set] SpO

output

RvO: 7500 RPM
 SpO: 30 km/h
 RvW: 5000 RPM
 SpW: 100 km/h
 SLC: 170 km/h

This function allows an open collector transistor to turn ON when SPEED exceeds a preset value.

[Default Value] 60km/h (MAX 12V. 200mA)

Ex) If the Speed output is set to 30km/h, the radar will operate when speed exceeds 30km/h.

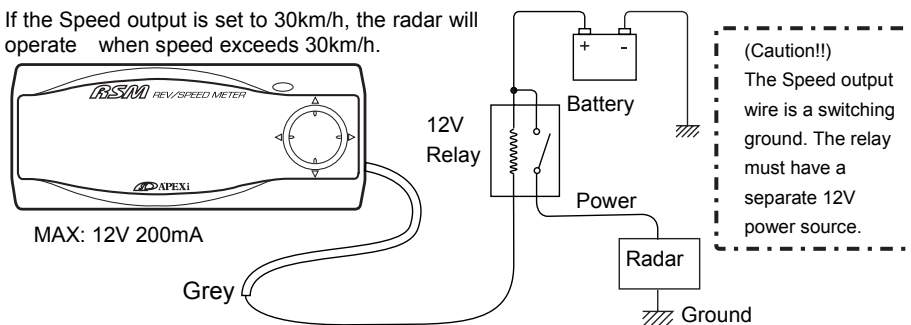

Using the Warning Display

Numerical Values will flash when HIGHER than the preset engine RPM (Monitor Mode RPM Warning Display) P48 [etc.] → [Output Set] RvW

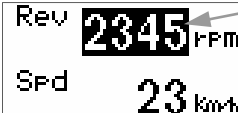

output

RvO: 7500 rPm
SpO: 210 km/h
RvW: 2000 rPm
SpW: 100 km/h
SLC: 170 km/h

2 Channel Monitor Mode Display

The Numerical value will flash when HIGHER than the preset level during Monitor Mode, and 1 Channel Analog + Numerical Display [Default] 5000rpm

Initial Settings

Numerical Values will flash when HIGHER than the preset speed (Monitor Mode) Speed Warning Display P48 [etc.] → [Output Set] SpW



output

RvO: 7500 rPm
SpO: 210 km/h
RvW: 5000 rPm
SpW: 100 km/h
SLC: 170 km/h

2 Channel Monitor Mode Display

The Numerical value will flash when HIGHER than the preset level during Monitor Mode, and 1 Channel Analog + Numerical Display [Default] 100km/h



Chapter 3 **Operation**



Function and Operation	_____	20
Monitor Mode Overview	_____	22
Measure Mode Overview	_____	23
Etc. Mode Settings	_____	23

Function and Operation

Main Menu

The RSM utilizes 3 Main Menus for easy navigation.

```
main
1. Monitor
2. Measure
3. etc.
```

Monitor Mode

Displays Sensor Data

```
monitor
1. 1channel
2. 2channel
3. 3channel
4. 4channel
5. Rev. -[V]
6. G-FR/RL
```

Engine RPM, Speed, Battery Voltage, Trabel Distance, and 4-way Acceleration Measurement (When using optional G Sensor)

Measure Mode

Measure Various Parameters

```
measure
1. 0-###Gm
2. 0-###k
3. ##-##k
4. STOP-W
5. POWER
6. LOSS-P
```

0-100,200,400m acceleration
0-100,200,300km/h acceleration
Preset Mid-Range acceleration Stopwatch, Power, Loss Power

Etc. Mode

Used for Initial Setting Procedures

```
etc.
1. Output set
2. Grph Scale
3. Car Select
4. VFD Bright
5. Gsnsr Corr
6. Initialize
```

Allows initial setup of :
Vehicle settings, Output settings, Initialize Functions.

■ [1Channel~4Channel] Display Parameters

1. Rev.....Engine RPM
2. Spd.....Vehicle Speed
3. TrpTravel Distance
4. F/R.....Front/Rear Acceleration Measurement
5. R/L.....Left/Right Acceleration Measurement
6. Bat.....Battery Voltage

■ Rev.-[Y] Display Parameter

Displays a plotted graph with Engine RPM as the horizontal axis.

1. Speed.....Vehicle Speed
2. Gs F/R.....Front/Rear Acceleration Measurement
3. Gs R/L.....Left/Right Acceleration Measurement

■ G-FRIRL Display

Displays acceleration. Using the center of the graph as the starting point, the unit measures front and rear G's on the vertical axis and left and right G's on the horizontal axis.



■ Measuring Parameters

1. 0-*00m.....0-100,200,400m Measurement
2. 0-*00k.....0-100,200,300km/h Measurement
3. **-*k.....User Preset Mid-Range Acceleration
4. STOP-W Stop Watch (Lap/Split)
5. POWER..... Power Measurement
6. LOSS-P..... Loss Power Measurement



■ Setting Parameter

1. Output Set.....RPM/Speed Output Setting
RPM/Speed Warning Display
Speed Limiter Cut Setting
2. Grph ScaleGraph Scale Setting
3. Car Select Cylinder Number Setting, Speed Pulse Setting
Speed Pulse Adjust Setting, Tire Size Setting
Vehicle Weight Setting
4. VFD Bright.....VFD Adjustment
5. Gsnsr CorrG Sensor Calibration
6. InitializeInitialize All Data



Main Menu [Monitor] Monitor Mode Overview

[Displays between 1~4 parameters]

P26 [Monitor] → [1Channel] ~ [4Channel]

[Parameter Glossary]

1. Rev..... Engine RPM
2. Spd..... Vehicle Speed
3. Trp Travel Distance
4. F/R..... Front/Rear Acceleration Measurement (Using G Sensor)
5. R/L..... Right/Left Acceleration Measurement (Using G Sensor)
6. Bat Battery Voltage

[Display Method]

Numerical, Analog Display	Real Time, Peak Hold, Pause
Graph Display	Real Time, Replay, Pause

[Plots engine RPM on the horizontal axis]

P30 [Monitor] → [Rev. - [Y]]

[Vertical Contents Axis] Selects and displays 1 parameter out of 3

1. Speed Vehicle Speed
2. Gs F/R..... Front/Rear Acceleration Measurement (Using G Sensor)
3. Gs R/L..... Right/Left Acceleration Measurement (Using G Sensor)

[Display Method]

1 point display, 10 point display, Ghost Map Trace
..... Real Time Display, Replay Display, Pause

[Plot and display 4 way acceleration]

P31 [Monitor] → [G-FR/RL] (Using optional G Sensor only)

[Display Method]

1 point display, 10 point display, Ghost Map Trace
..... Real Time Display, Replay Display, Pause

Main Menu [Measure] Measure Mode Overview

1. 0-*00m	P34
0-100,200,400m Acceleration Measurement	
2. 0-*00k	P36
0-100,200,300km/h Acceleration Overview	
3. **-*k	P38
Preset Mid-Range Acceleration Overview	
4. STOP-W	P40
Stop Watch (Lap/Split)	
5. POWER	P42
Power Measurement	
6. LOSS-P	P43
Loss Power Measurement	

Main Menu [etc.] Etc. Mode Settings

1. Output Set	P48
RPM/Speed/RPM Warning/Speed Warning Speed Limiter Cut Setting	
2. Grph Scale	P49
Graph Scale Setting	
3. Car Select	P50
Cylinder Setting, Speed Pulse Setting, Speed Pulse Related Setting, Tire Correction, Vehicle Weight	
4. VFD Bright	P51
VFD Adjust	
5. Gsnsr Corr	P52
G Sensor Calibration	
6. Initialize	P53
Initialize All Data	

Chapter 4 Monitor Mode



Choosing between 1~4 channels _____	26
Graph Mode plotting RPM as Horizontal Axis _____	30
Graph Mode plotting Front Rear Left Right Acceleration _____	31

【monitor】 → 【1Channel】 ~ 【4Channel】 Choosing Between 1~4 Channels

1~4 Channels can be selected from the 6 parameters below. The data can be displayed in Numerical, Analog, and Graph Modes. Each mode allows a Pause function. Also, Numerical and Analog modes have Peak Hold, while the Graph Mode has Replay.

【CAUTION】 Replay Mode will replay the most recent memorized data Despite changing any of the parameters. Replay Mode will continue to replay the same data.

■ Display Parameters

- | | | |
|------------------------|------------------------|-----------------------------|
| 1. Rev Engine RPM | 2. Spd Speed | 3. Trp..... Travel Distance |
| 4. F/R... Fr/Rr Accel. | 5. R/L... Lt/Rt Accel. | 6. Bat..... Battery Voltage |

● Numerical Display Example

【Function】 Pause, Peak Hold

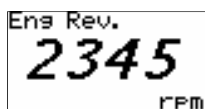

1 Channel Display

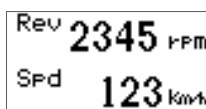

2 Channel Display

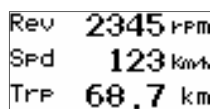

3 Channel Display

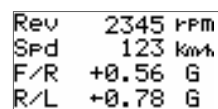

4 Channel Display

● Analog Display Example

【Function】 Pause, Peak Hold

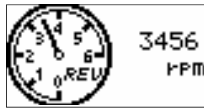

1 Channel Display

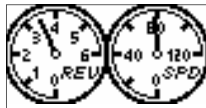

2 Channel Display

● Graph Display Example

【Function】 Pause, Replay

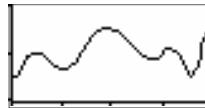

1 Channel Display

1. In the Main Menu, select
【Monitor】



Main Menu

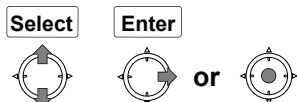

2. In Monitor Menu, select
【1~4Channel】

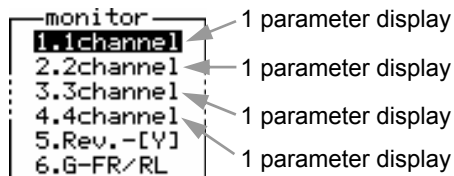

Monitor Menu

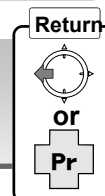
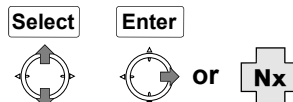

To next page 

3. Select data from parameter screen

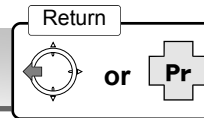

■ When selecting [1 Channel]

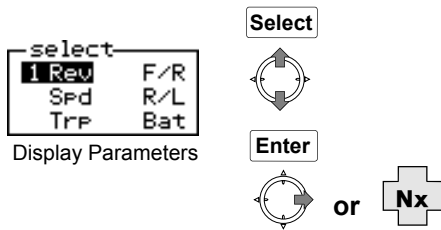

- (1) **Selecting Parameter**
In the Display Parameter Mode, press the button up or down. Selected parameter will illuminate.
- (2) **Display Parameter**
Press the button to the right, or push the center of the button and select **[Nx]** from the Pop Up Menu

■ When selecting [2~4 Channel]

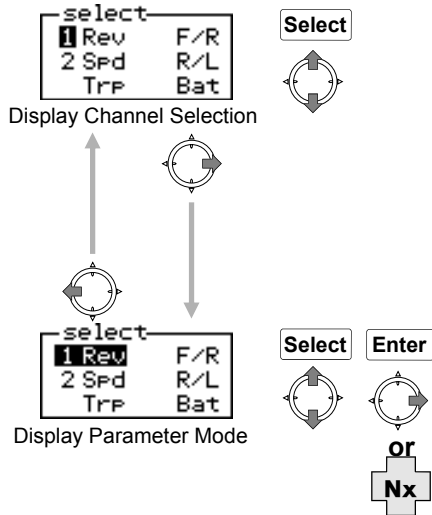

The example above is for [2 channel]

- (1) **Selecting Channel**
In the Display Channel Mode, press the button up or down. Selected parameter will illuminate.
- (2) **Selecting Parameter**
Choose the Display Channel, push the button to the right for Display Parameter Mode. Channel number and Parameter will illuminate. Push the button up or down to select.
- (3) **Selecting Display Parameter for another channel**
In the Display Parameter Mode, press the button to the left and return to the channel mode. Repeat steps (1) and (2) till complete.
- (4) **Display Parameter**
Press the button to the right, or push the center of the button and select **[Nx]** from the Pop Up Menu

Monitor Mode

← **Continuation from last page**

4. Selected Parameters will Display



Choosing [Nx] on the Pop Up Menu will toggle between
 (Numerical Display) →
 (Graph Display) →
 (Analog Display) →
 (Numerical Display) etc...

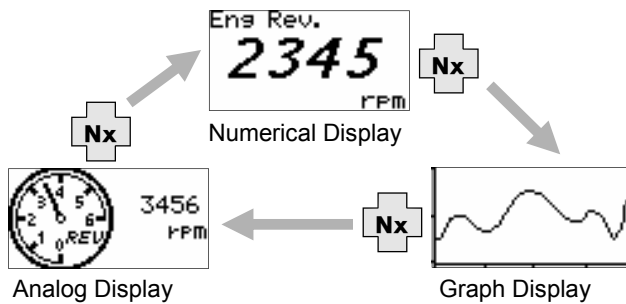

Meter Mode can display up to 2 parameters. When selecting 3 only the first 2 will display.

● **Numerical/Analog Display Functions**

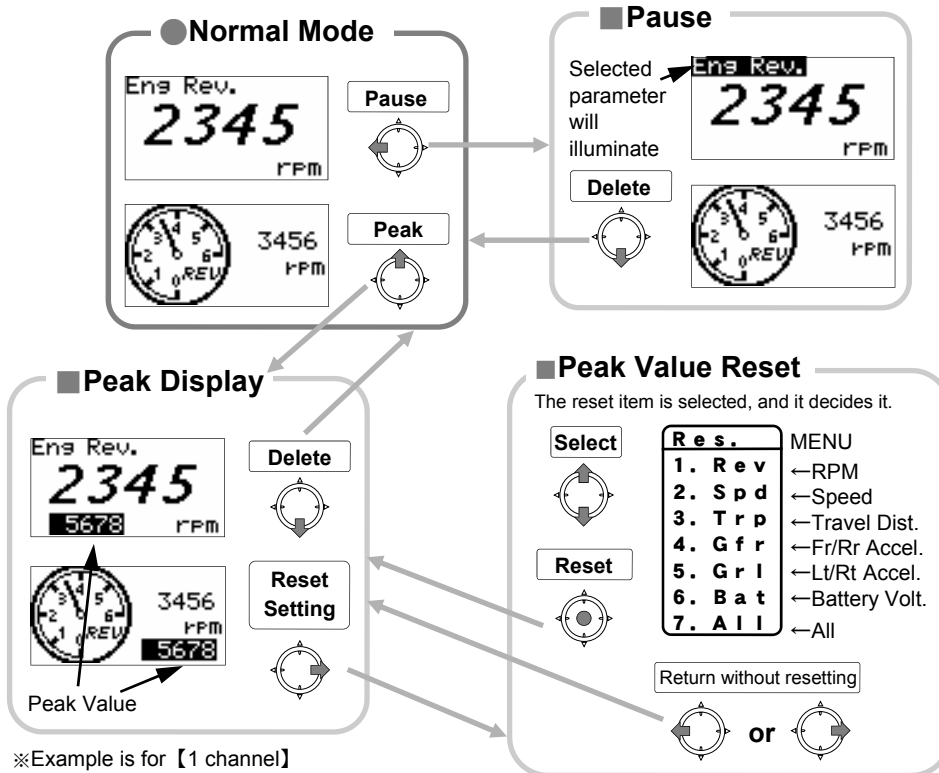

※Example is for [1 channel]

【monitor】 → 【1Channel】 ~ 【4Channel】
Choosing Between 1~4 Channels

● **Graph Display Functions** ※Examples is for 【1 channel】

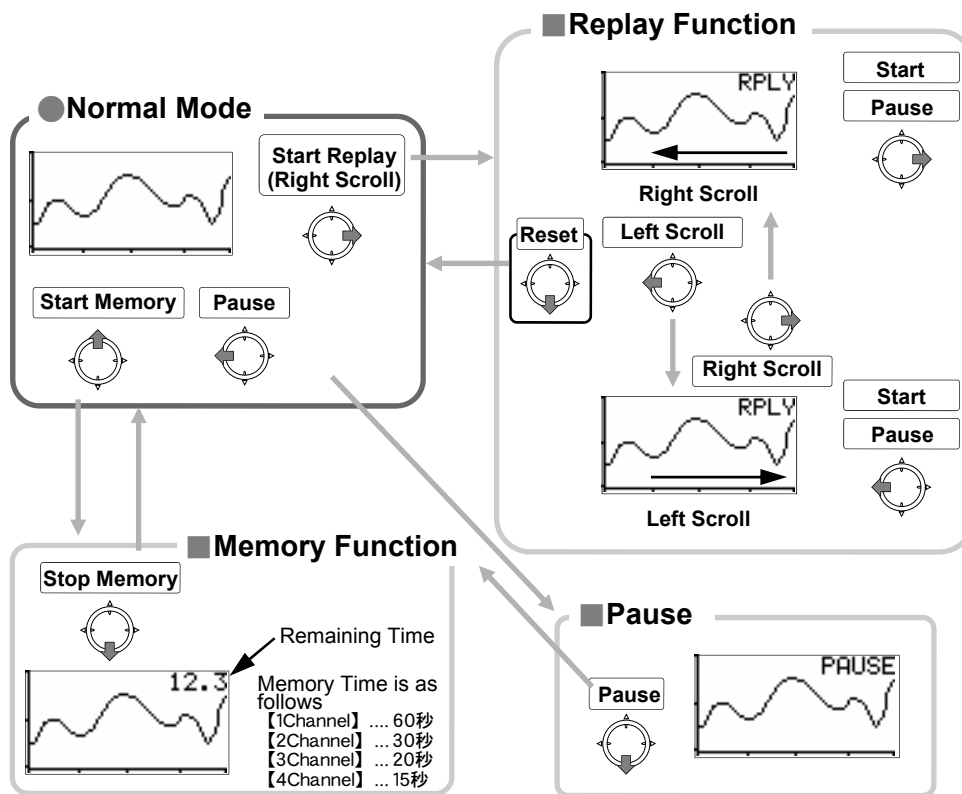

Monitor Mode

■ Numerical Display Flashes?!

Is the RPM/Speed Warning Output activated?
 When Rev [Engine RPM] and Speed [Spd] is displayed and the value exceeds the preset Warning Setting, the number will flash, P48.

■ Analog Display will not Function?!

Is the Pause function ON?
 The Analog Display will not operate if it is Paused. Release the Pause and try again.

【Caution】 Travel distance may be recorded up to 3000km After 3000km, the meter will return to 0km and the 【1~4 channel】 , 【Rev.-[Y]】 , 【G-FR/RL】 memory will be cleared. Also, in some instances, turning the power OFF immediately after or during movement may erase the travel distance.

【monitor】 → 【Rev. - [Y]】

Graph Mode plotting RPM as Horizontal Axis

1. Select [Monitor] from the Main Menu

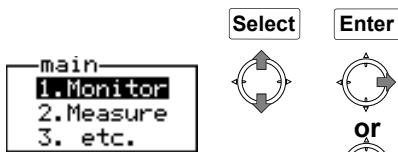

2. Select [Rev.-[Y]] In Monitor Menu

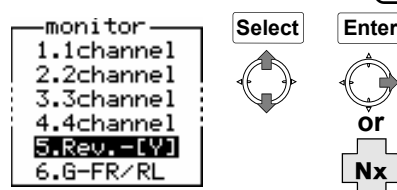

3. Select data from the Parameter Selection Menu

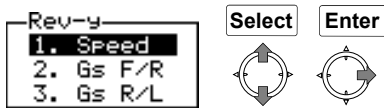

- 1. Speed Vehicle Speed
- 2. Gs F/R..... Fr/Rr Accel
- 3. Gs R/L..... Lv/Rr Accel

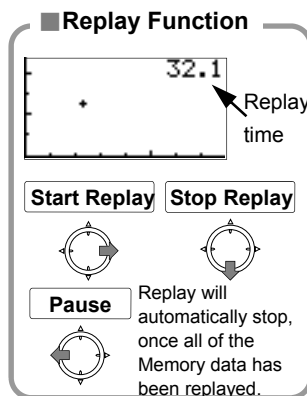
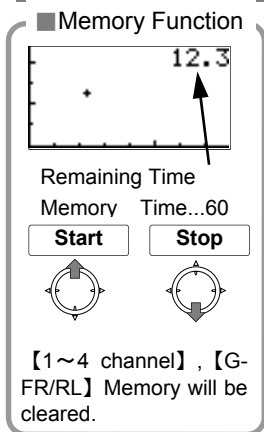

4. Selected data will display

Push the center button and activate [Nx] on the Pop Up Menu to toggle between (1 point display) →(10 point display)→(Ghost Map Trace) →(1 point display)..etc.

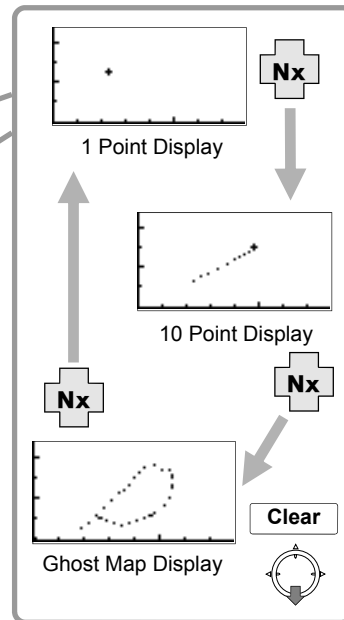

【monitor】 → 【G-FR/RL】
Graph Mode plotting Fr/Rr/Lt/Rt Acceleration

1. Select 【Monitor】 from the 【Main Menu】

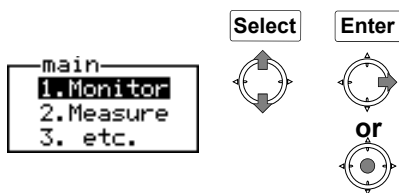

2. Select 【G-FR/RL】 In Monitor Mode

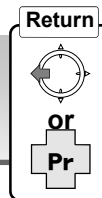
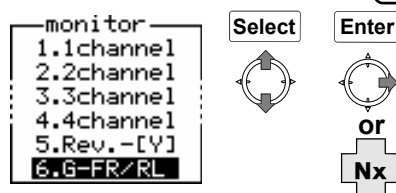

3. Items will display



Push the center button and activate **【Nx】** on the Pop Up Menu to toggle between (1 point display)→(10 point display)→(Ghost Map Trace)→(1 point display)...etc..

Monitor Mode

■ Plotting Direction

Using the optional G Sensor allows acceleration to be plot graphically. The center of the graph denotes 0G. Acceleration moves the pointer UP, while deceleration moves the pointer DOWN. Cornering G's can also be plotted left

■ Memory Function

■ Replay Function

Chapter 5 Measure Mode



0-100,200,400m Acceleration _____	34
0-100,200,300km/h Acceleration _____	36
Preset Mid Range Acceleration _____	38
Stop watch (Lap. Split) Measurement _____	40
Power Measurement _____	42
Loss Power Input/Measurement _____	43

【measure】 → 【0-∗00m】
0-100,200,400m Acceleration

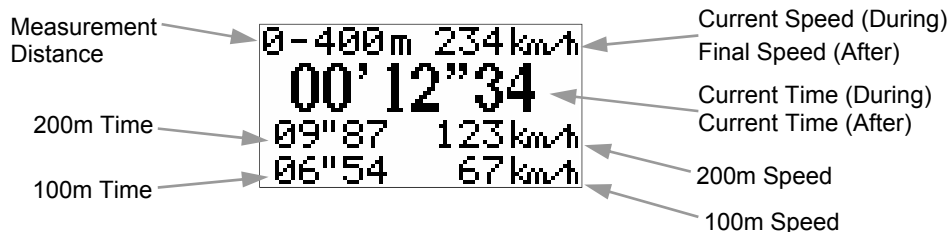

1. Select 【measure】 from the Main Menu

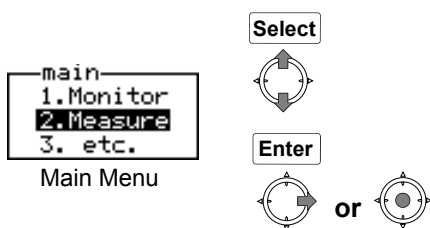

2. Select 【0-∗00m】 from Measure Mode

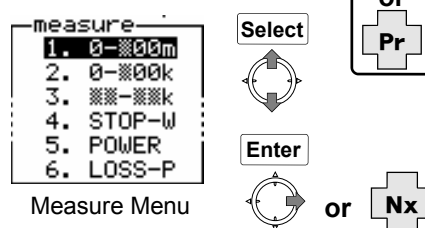

3. Screen will display 0-∗00m measuring mode

Choose from 0-100,200,400m distance to measure.

① Choose a measuring distance

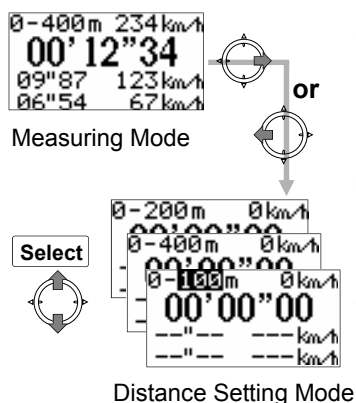

- (1) **Enter Distance Setting Mode**
 In Measuring Mode, pressing the Left or Right button will cause the Distance setting portion of the screen to illuminate, allowing the measurement distance to be selected.
- (2) **Select a Distance**
 Push the button UP or DOWN to change the Distance values. User can select between 0-100m, 0-200m, 0-400m.
- (3) **Return to Measuring Mode**
 Once desired Distance is set, pushing the button to the Left or Right will return to Measuring Mode.

② Measure

0-400m 234km/h
00'12"34
09"87 123km/h
06"54 67km/h

Measuring Mode

Measure



0-100m Ready!
00'00"00
---"--- ---km/h
---"--- ---km/h

Measuring Stand-By

(1) Prepare

Pressing the button DOWN will show [Ready!] to flash on screen placing the unit in stand-by mode. (If pressed during driving, [Ready!] will appear after the car has stopped. Real Time display of speed will occur during driving.)

(2) Measure

During Stand-By, when the unit receives an input signal from the vehicle speed signal (when the tires start to spin), measurement will begin.

(3) Finish Measurement

Measurement will stop once the specified Distance has been reached.

View the Best 5 Records, Clear the Records

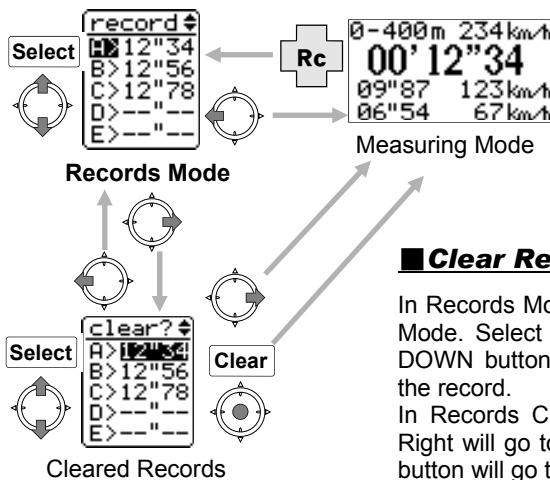

View the Best 5 Records

In Measuring Mode, pushing the center button and selecting Rc will activate the Records Mode. Press UP or DOWN to view desired record.

Clear Records

In Records Mode, push Right to enter Records Clear Mode. Select the record to clear using the UP and DOWN button. Pushing the Center button will clear the record.

In Records Clear Mode, pushing the button to the Right will go to Measure Mode, and pushing the Left button will go to Records Mode.

Measure Mode

● Caution when installing the optional G Sensor (separately sold)

The G Sensor corrects the vehicle speed signal. Incorrect installation and calibration of the G Sensor will cause incorrect readings. ⇒ **G Sensor Calibration**

【measure】 → 【0-∗00k】
0-100,200,300km/h Acceleration

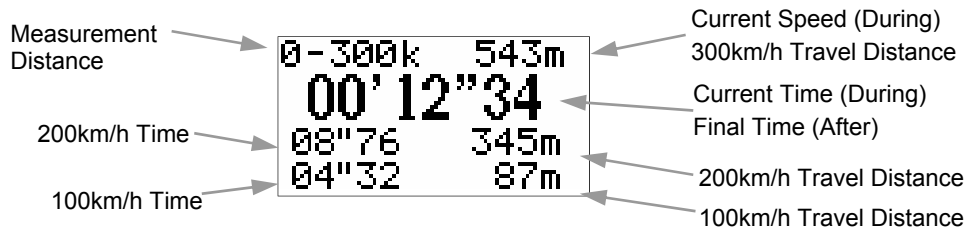

1. Select 【measure】 from the Main Menu

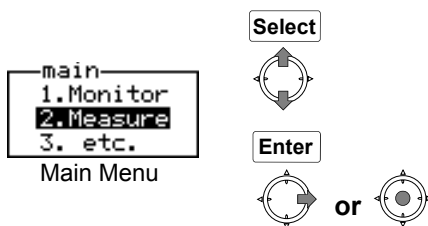

2. Select 【0-∗00k】 from Measure Mode

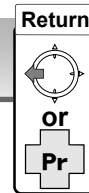
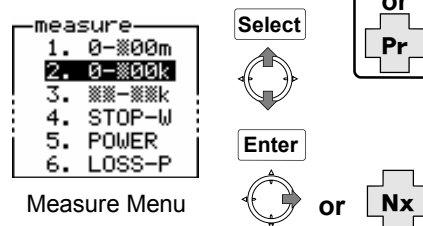

3. Screen will display 0-∗00k Measuring Mode



Choose from 0-100,200,300km/h speeds to measure.

① Choose a measuring speed

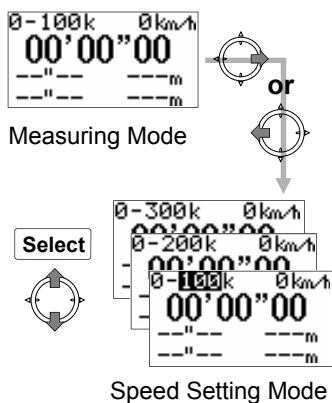

(1) Enter Speed Setting Mode

In Measuring Mode, pressing the Left or Right button will cause the Speed setting portion of the screen to illuminate, allowing the measurement speed to be selected.

(2) Select a Speed

Push the button UP or DOWN to change the Speed values. User can select between 0-100km/h, 0-200km/h, 0-300km/h.

(3) Return to Measuring Mode

Once desired Speed is set, pushing the button to the Left or Right will return to Measuring Mode.

② Measure

Measuring Mode

Measure

Measuring Stand-By

(1) Prepare

Pressing the button DOWN will show [Ready!] to flash on screen placing the unit in stand-by mode. (If pressed during driving, [Ready!] will appear after the car has stopped. Real Time display of speed will occur during driving.)

(2) Measure

During Stand-By, when the unit receives an input signal from the vehicle speed signal (when the tires start to spin), measurement will begin.

(3) Finish Measurement

Measurement will stop once the specified Speed has been reached.

View the Best 5 Records, Clear the Records

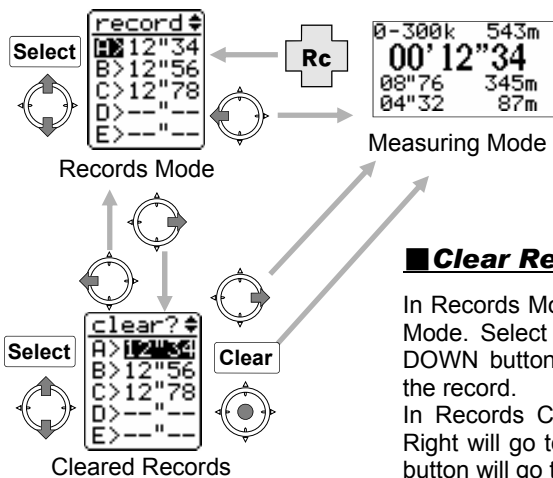

View the Best 5 Records

In Measuring Mode, pushing the center button and selecting Rc will activate the Records Mode. Press UP or DOWN to view desired record.

Clear Records

In Records Mode, push Right to enter Records Clear Mode. Select the record to clear using the UP and DOWN button. Pushing the Center button will clear the record.

In Records Clear Mode, pushing the button to the Right will go to Measure Mode, and pushing the Left button will go to Records Mode.

Measure Mode

● Caution when installing the optional G Sensor (separately sold)

The G Sensor corrects the vehicle speed signal. Incorrect installation and calibration of the G Sensor will cause incorrect readings. ⇒ **G Sensor Calibration**

[measure] → [-**k]**

Preset Mid Range Acceleration



1. Select [measure] from the Main Menu

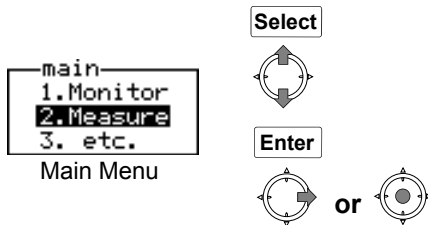

2. Select [-**k] from Measure Menu**

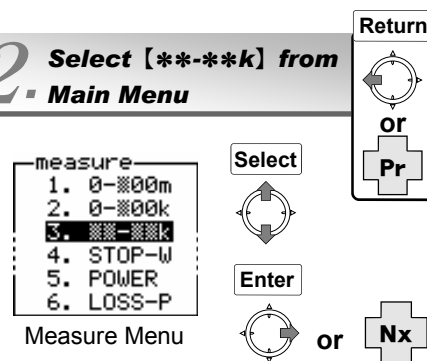

3. Screen will display **-k Measuring Mode**

Choose any range of speed between 0-250 km/h to measure.

① Set Measuring Speed

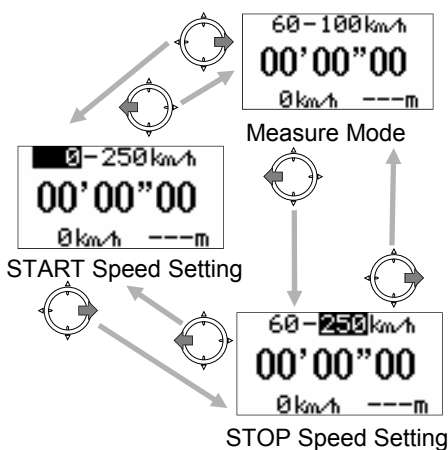

(1) Enter Speed Setting Mode

In Measure Mode, push the button to the Left to illuminate the STOP Speed Display, and to the Right to illuminate the START Speed Display.

(2) Set Desired Speed

Push the button UP or DOWN to change Speed values. Speed range is to be selected between 0-250km/h. Push the button to the Left to set START, and to the Right to set STOP.

(3) Exit Speed Setting Mode

Set parameters to desired settings and press Left of Right to return to Measure Mode.

② Measure

100-200 km/h
00' 12" 34
234 km/h 876 m

Measure Mode

Measure



60-100 km/h
00' 00" 00
0 km/h Ready!

Measuring Stand-By

(1) Prepare

Pressing the button DOWN will show [Ready!] to flash on screen placing the unit in stand-by mode. (If pushed when above START speed, [Ready!] will flash when speed falls under START speed.)

(2) Measure

During Stand-By, measurement will begin once vehicle speed exceeds the START speed.

(3) Finish Measurement

Measurement will stop once the specified Speed has been reached.

View the Best 5 Records, Clear the Records

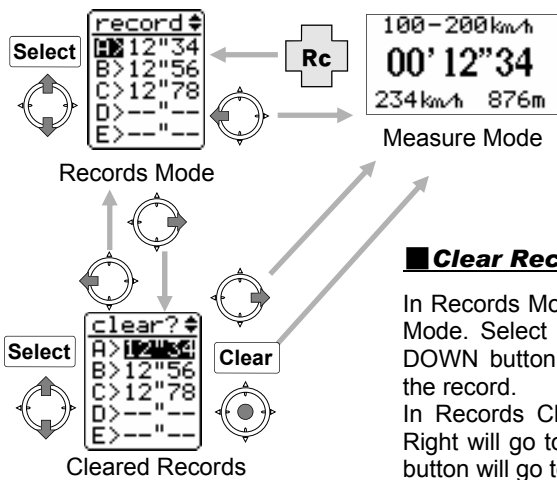

View the Best 5 Records

In Measuring Mode, pushing the center button and selecting Rc will activate the Records Mode. Press UP or DOWN to view desired record.

Clear Records

In Records Mode, push Right to enter Records Clear Mode. Select the record to clear using the UP and DOWN button. Pushing the Center button will clear the record.

In Records Clear Mode, pushing the button to the Right will go to Measure Mode, and pushing the Left button will go to Records Mode.

Measure Mode

● Caution when installing the optional G Sensor (separately sold)

The G Sensor corrects the vehicle speed signal. Incorrect installation and calibration of the G Sensor will cause incorrect readings. ⇒ **G Sensor Calibration**

【measure】 → 【STOP-W】

Stop Watch (Lap/Split) Measurement

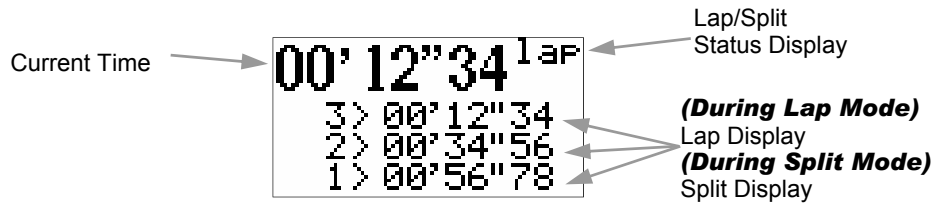

1. Select 【measure】 from the Main menu

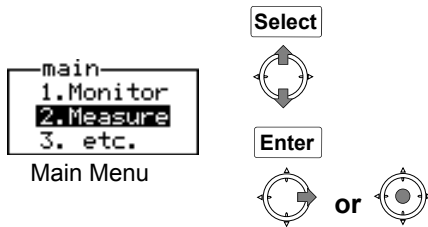

2. Select 【STOP-W】 from Measure mode

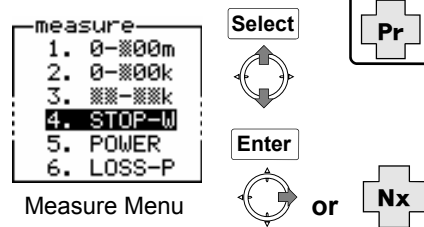

3. Screen will display Stop Watch Measuring Mode

① Select between Lap and Split Modes of Measurement.

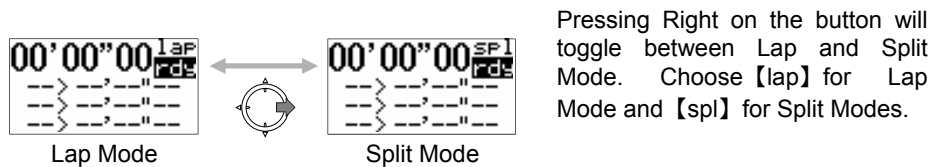

② Operational Procedures

START STOP Press the Button UP to start measurement.
Pressing the button UP during measurement will stop this function.



Lap/ Split Press DOWN to measure Lap/Split. (During Measurement)



AUTO START Press the Button to the Left, [rdy] will appear on screen. Once the input vehicle speed signal is received (tires start to spin) measurement will start.)



Reset Press DOWN to reset measuring results. (After Measurement)



● **Multiple Time Measurement**

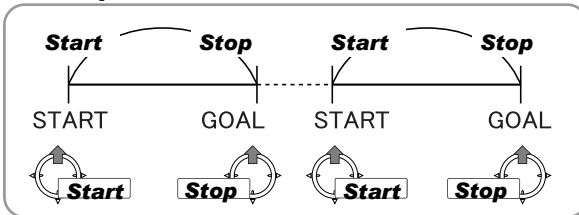

Display Example

```
00' 12" 34LAP
2> 00' 12" 34
1> 00' 12" 78
```

Reset



● **Lap Time Measurement When selecting [lap]**

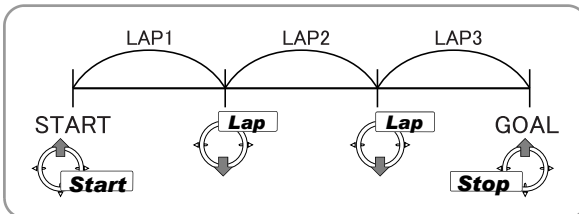

Display Example

```
00' 12" 34LAP
3> 00' 12" 34
2> 00' 12" 56
1> 00' 12" 78
```

Reset



● **Split Time Measurement When selecting [spl]**

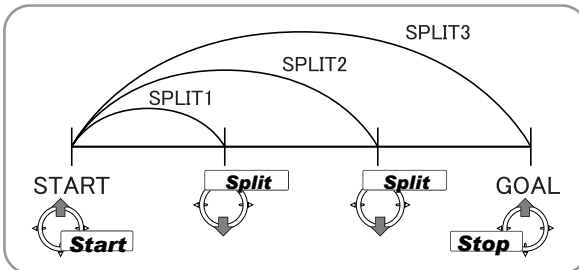

Display Example

```
00' 12" 34SF1
3> 00' 12" 34
2> 00' 08" 90
1> 00' 04" 56
```

Reset



■ **Check Lap/Split Times**

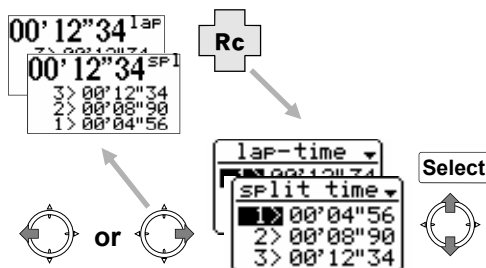

[After Measurement] Press the center button and select Rc to enter Records Mode. Press UP or DOWN to select desired record. The unit can store up to 20 Lap/Split times. These records will be erased when the ignition key is removed.

Measure Mode

【measure】 → 【POWER】

Power Measurement (only available with optional G sensor)

1. Select [measure] from the Main menu

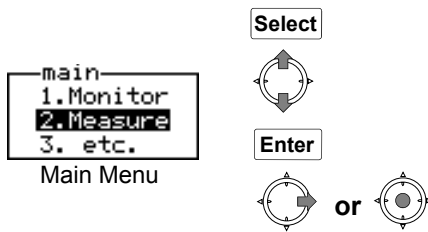

2. Select [POWER] from Measure mode

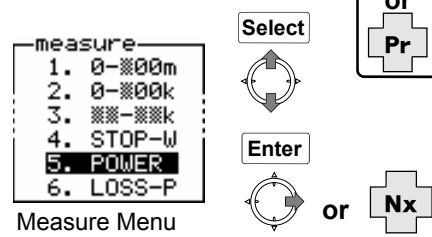

3. Screen will display Power Measure Mode

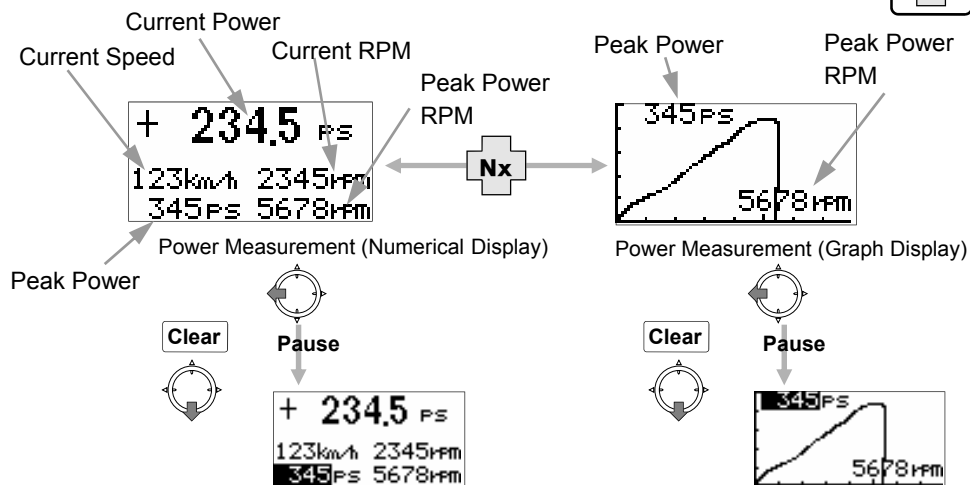

- The optional G Sensor (sold separately) must be used for this function.
- Loss Power and vehicle weight must be input for this measurement.
- Measure only on flat surfaces. Uphill measurements will produce higher results, while downhill measurements will produce lower results than actual power.

【measure】 → 【LOSS-P】

To next page 

Loss Power Input/Measure (only for use with optional G Sensor)

When using the optional G Sensor to measure Power, Loss Power values must be input. The table below lists some typical Loss Power data for vehicle categories. Choose the closest Loss Power data from below taking vehicle type, drive-train, and weight into consideration.

Also, for more accurate Loss Power data, custom values may be input directly. Please refer to the next page for more information.

Table 1 【Ex】 Typical Loss Power Data

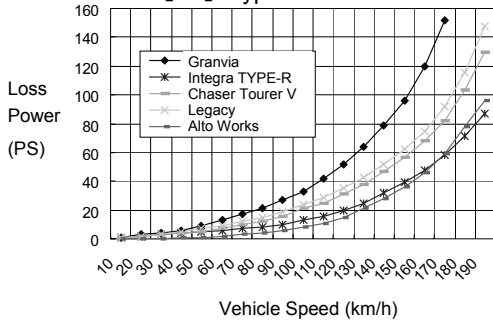

Name	Type	Drive-train	Weight
Granvia	Minivan	4WD	2200Kg
Legacy	Wagon	4WD	1650Kg
Chaser	Sedan	FR	1600Kg
Integra	Coupe	FF	1150Kg
Alto	Kei-Hatch back	FF	800Kg

Diagram1 【Ex】 Typical Loss Power Data

Name	Vehicle Speed (km/h)									
	10	20	30	40	50	60	70	80	90	100
Granvia	1	3	4	6	9	13	17	21	27	33
Integra Type R	1	2	3	4	5	6	7	8	10	13
Chaser Tourer V	1	2	3	4	5	7	10	12	16	21
Legacy	1	2	3	5	7	9	12	15	19	24
Alto Works	0	0	0	1	1	2	3	4	6	8

Name	Vehicle Speed (km/h)								
	110	120	130	140	150	160	170	180	190
Granvia	42	52	64	79	96	120	152	-	-
Integra Type R	16	20	25	32	39	48	58	71	87
Chaser Tourer V	25	31	38	47	57	68	82	103	130
Legacy	29	35	43	52	62	75	92	116	148
Alto Works	11	15	21	28	36	46	59	78	96 (PS)

Diagram2 【Ex】 Typical Loss Power Data

Measure Mode

Loss Power

Loss Power is a combination of Wind resistance, Tire friction, Drive-train friction (Engine, Transmission, Differential, etc...) produced by the vehicle during movement. Loss Power values can change constantly due to atmospheric conditions, tire pressure, as well as engine/drive-train oil temperatures.

← Continuation from last page

1. Select [measure] from the Main menu .

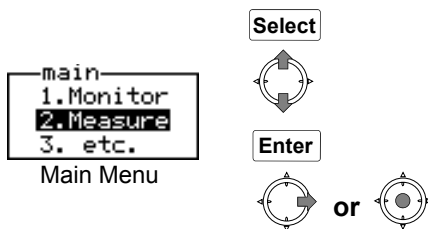

2. Select [LOSS-P] from Measure mode

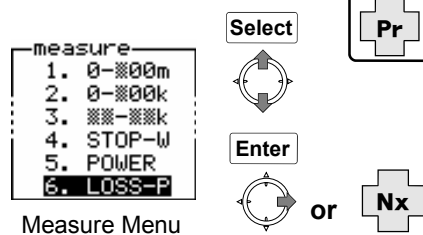

3. Screen will display Loss Power Input Measure Mode

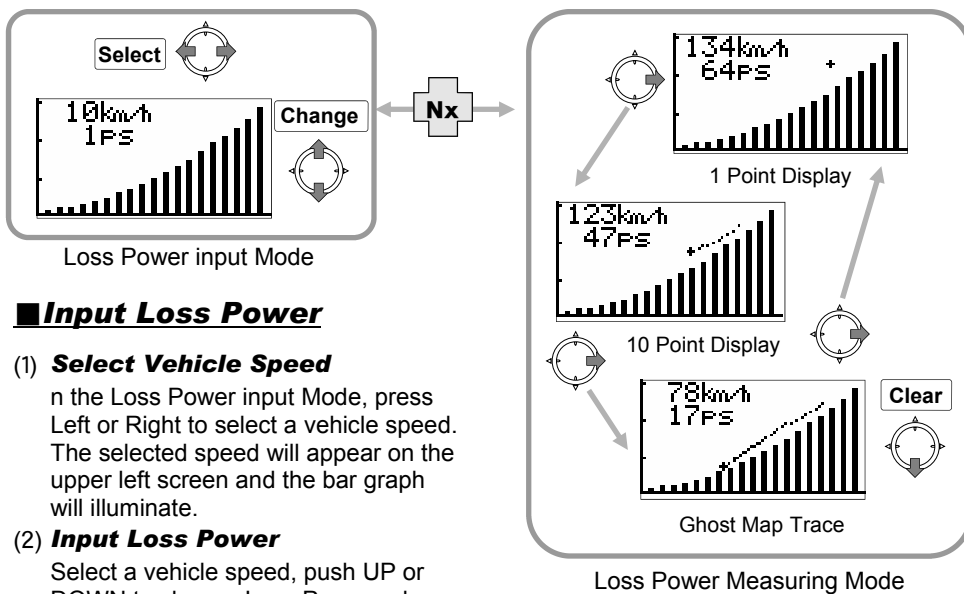

Input Loss Power

- (1) **Select Vehicle Speed**
In the Loss Power input Mode, press Left or Right to select a vehicle speed. The selected speed will appear on the upper left screen and the bar graph will illuminate.
- (2) **Input Loss Power**
Select a vehicle speed, push UP or DOWN to change Loss Power values on graph.
- (3) **Select Another Vehicle Speed**
Repeat steps (1),(2)

[measure] → [LOSS-P]

Loss Power Input/Measure

Measure Loss Power

● **Secure a Safe Testing Road**

Measure on a long, flat road surface. (Avoid public roads when possible.) Any type of hill or curve will increase the resistance placed on the vehicle (ie. through tire friction, engine load) and prevent an accurate calculation.

● **Select Ghost Map Trace while in Loss Power Mode**

Switch to Ghost Map Trace While in Loss Power Mode. While decelerating, make sure that the Loss Power is plotted on the graph.

(1) **Set Measuring Speed**

Set the Measuring Speed 10km/h ABOVE desired speed. For example, if desired measurement speed is 90 km/h, then set the unit to 100 km/h.

(2) **Press the Button DOWN**

All previously stored Loss Power data will be cleared.

(3) **Measure**

Once at measuring speed, put the vehicle in neutral and decelerate without using the brake. The Loss Power will be plotted on the graph.

(4) **Input Loss Power**

Enter Loss Power Input Mode, and match the bar graph to the plotted Ghost Map Trace.

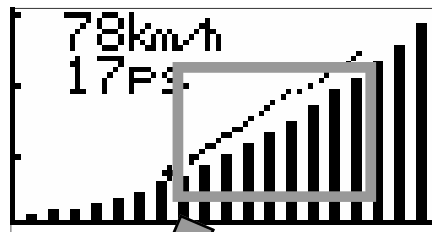

Match the bar graph to this plotted line

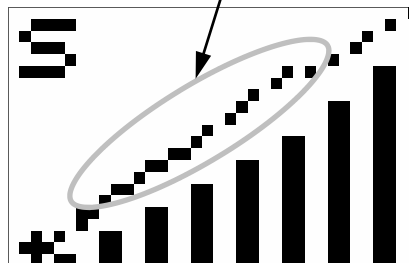

Measure Mode

Follow the steps above to input Loss Power. If Loss Power cannot be measured in one run, measure from 100-50km/h, 100-60km/h etc... in multiple runs until all of the Loss Power has been input.



WARNING

● **Follow all of the rules and regulations of the public highway at ALL times.**



Chapter 6

Etc. Mode



Output Setting	48
Graph Scale Setting	49
Vehicle Specific Setting	50
VFD Adjustment	51
G Sensor Calibration	52
Initialize All Data	53
Troubleshooting	54

[etc.] → [Output set]

Output Setting

Rpm/Speed Output. RPM/Speed Warning Output Speed Limiter Cut Setting

This section will set the RPM/Speed Output, RPM/Speed Warning Output, and Speed Limiter Cut Settings

1. Select [etc.] from the [Main Menu]

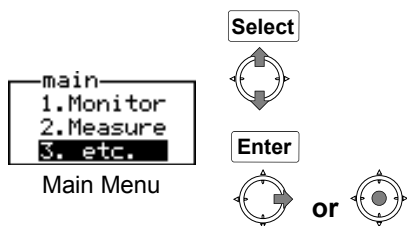

2. Select [Output Set] from the Etc. Menu.

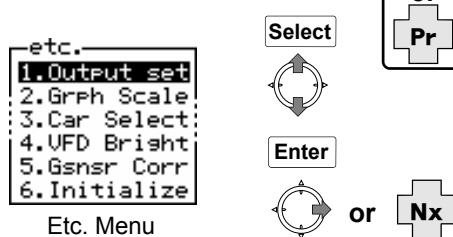

3. The screen will display Output Setting Mode

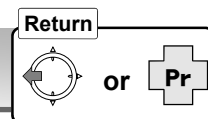

(1) Select Parameter

In the parameter selection screen, Press UP or DOWN to select a desired parameter to change. Selected parameter will illuminate.

(2) Set Values

Press the Right button on the selected parameter. This allows the value to be changed by pressing UP or DOWN.

⇒When changing other parameters

Press the button to the Left, and repeat steps (1) and (2).

(3) Finish Setting

Press the Center button and select [Pr] or press Left to return to the previous menu.

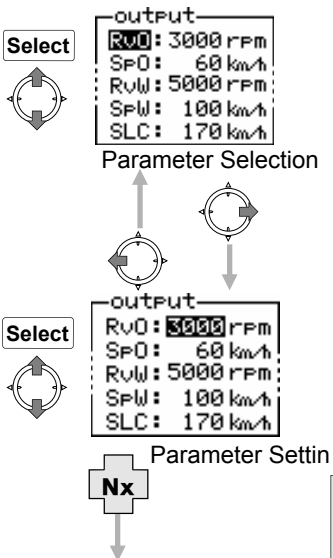

P49-3.
To Graph Scale
Setting Mode

Setting Parameter	Listed are default value
R e O 【RPM Output】	100~9900,OFF (3000) [rpm]
S p O 【Speed Output】	1~300,OFF (60) [km/h]
R v W 【RPM Warning Output】	100~9900,OFF (5000) [rpm]
S p W 【Speed Warning Output】	1~300,OFF (100) [km/h]
S L C 【Speed Limiter Setting】	10~200,OFF (170) [km/h]

[etc.] → [Grph Scale] Graph Scale Setting

Changes the Analog and Graph Display Scales

1. Select [etc.] from the Main Menu

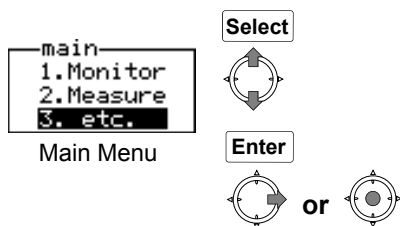

2. Select [Grph Scale] from the Etc. Menu

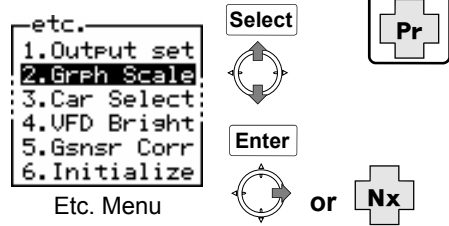

3. The screen will display Graph Scale Mode

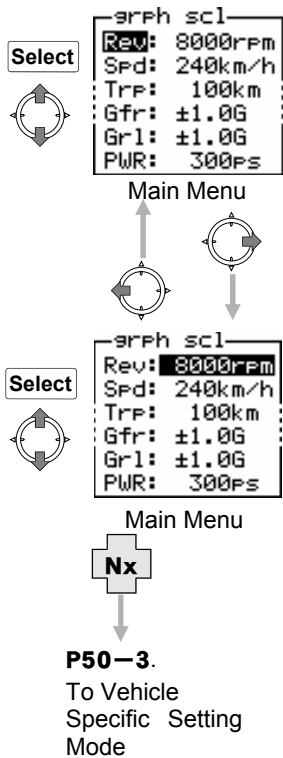

(1) Select Parameter

In the parameter selection screen, Press UP or DOWN to select a desired parameter to change. Selected parameter will illuminate.

(2) Set Values

Press the Right button on the selected parameter. This allows the value to be changed pressing UP or DOWN.

⇒ When changing other parameters

Press the button to the Left, and repeat steps (1) and (2).

(3) Finish Setting

Press the Center button and select [Pr] or press Left to return to the previous menu.

Setting Parameter	Listed are default value
Rev [RPM]	10000,9000, (8000) ,7000,6000 [rpm]
Spd [SPEED]	360,300, (240) ,180,120 [km/h]
Trp [Travel Distance]	1000,300, (100) ,30,10 [km]
Gfr [Fr/Rr Accel]	±2.0,±1.5, (±1.0) ,±0.6,±0.3 [G]
Gr1 [Rt/Lt Accel]	±2.0,±1.5, (±1.0) ,±0.6,±0.3 [G]
PWR [Power]	1000,600,400,200,150,100 [kw] 1200,800,500, (300) ,200,150 [ps]

Etc Mode

[etc.] → [Car Select] Vehicle Specific Setting

Allows setting of largest value for Analog and Graph Displays.

1. Select [etc.] from the Main Menu

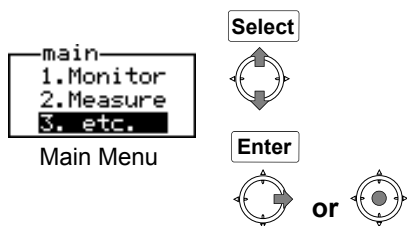

2. Select [Car Select] from the Etc. Menu.

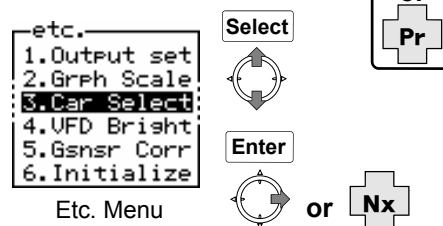

3. The screen will display Vehicle Specific Settings.

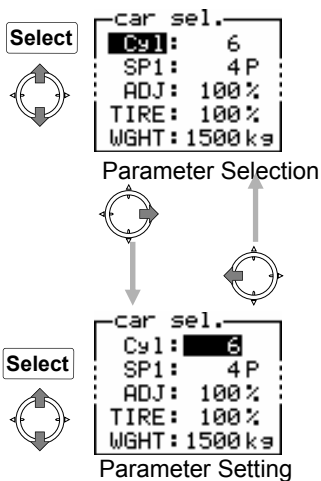
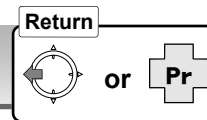

P51-3.
To VFD
Adjustment

(1) Select Parameter

In the parameter selection screen, Press UP or DOWN to select a desired parameter to change. Selected parameter will illuminate.

(2) Set Values

Press the Right button on the selected parameter. This allows the value to be changed by pressing UP or DOWN.

⇒ When changing other parameters

Press the button to the Left, and repeat steps (1) and (2).

(3) Finish Setting

Press the Center button and select [Pr] or press Left to return to the previous menu.

■ Setting Parameter Listed are default values

C y l	[cylinder]	1~16 (6) [cylinder]
S P 1	[vehicle pulse]	2,4,8,16,40,80,160 (4) [pulse]
A D J	[speed pulse adjust]	10~250 (100) [%]
T I R E	[tire correction]	50~150 (100) [%]
W G H T	[weight]	500~2500 (1500) [kg]

[etc.] → [VFD Bright] VFD Adjustment

This unit uses an internal light sensor to sense brightness, and adjusts VFD screen brightness automatically. The parameter reading **[Day]** is meant fro daytime, **[Dim]** is for dusk, **[Nig]** is for night time illumination. Adjustment should not be necessary during daytime.

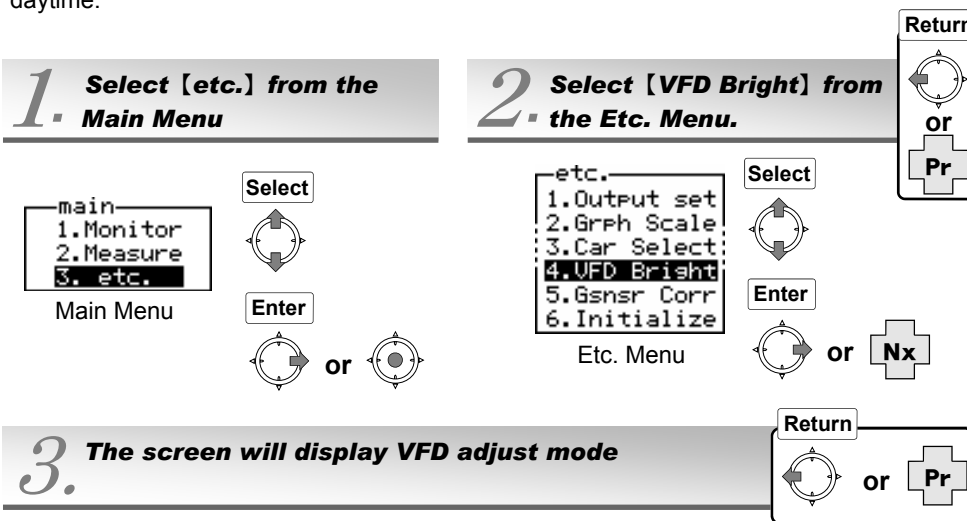

(1) Select Parameter

IN VFD Adjust Mode, press Left or Right to select the value to be changed. Selected value will illuminate.

(2) Set Values

Press UP or DOWN on selected parameter to change value. Higher value will brighten the screen while lower values will darken the screen.

⇒When setting other parameters

Repeat steps (1) and (2). .

(3) End Setting

Press the center button and select **[Pr]** from the Pop Up Menu. User can also push Left on **[Day]** or Right on **[Nig]** to return to the previous menu. .

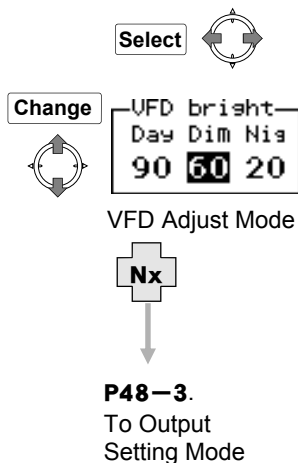

Etc Mode

[etc.] → [Gnsr Corr]

G Sensor Calibration

This will calibrate the 0 point of the separately sold G sensor. This process must be performed to ensure accurate acceleration readings. Always perform this process when installing or moving the G Sensor.

1. Select [etc.] from the Main Menu

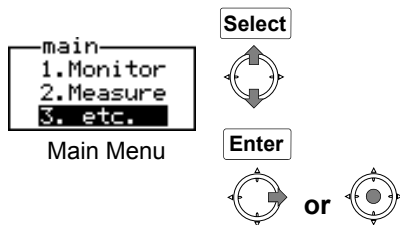

2. Select [Gnsr Corr] from the Etc. Menu

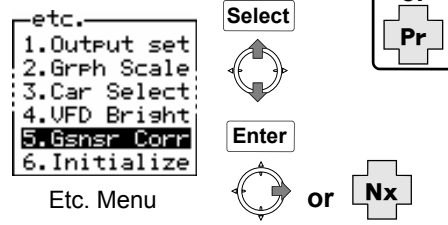

3. Screen will display G Sensor Calibration



⇒ Calibrate the G Sensor 0 Point

Once the G Sensor has been installed according to the G Sensor instruction manual, push the Left button and select [Yes] while in the G Sensor 0G Adjust Menu. Push the center button to select.

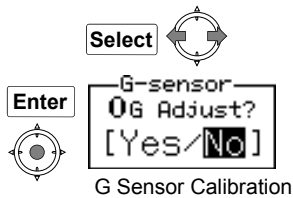

⇒ To Exit G Sensor Calibration Mode Without Changes

While in the G Sensor Calibration Mode,

- Select [No] and push center button
- Select [No] and push Right
- Select [Yes] and push Left

This will return the user to the previous menu.

● Correct Installation Position

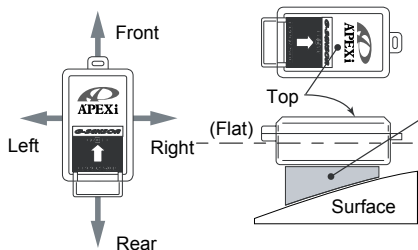

● Incorrect Installation Position

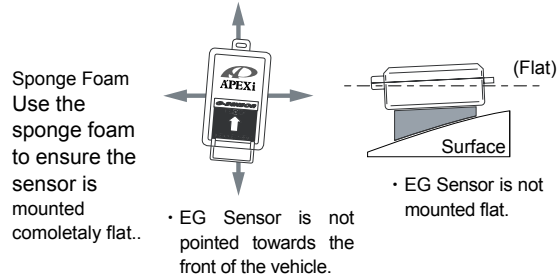

[etc.] → [Initialize]

Initialize All Data

This function will initialize all stored data and return the unit to factory default settings.

1. Select [etc.] from the Main Menu

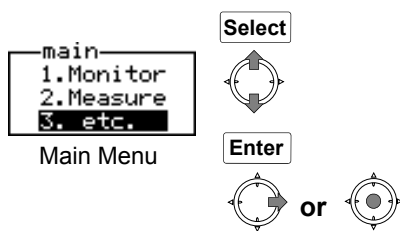

2. Select [Initialize] from the Etc. Menu

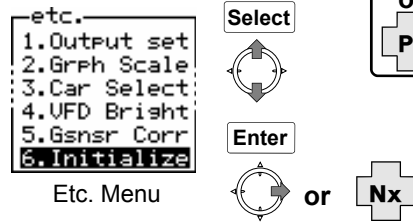

3. The Screen will display Initialize All Data Mode

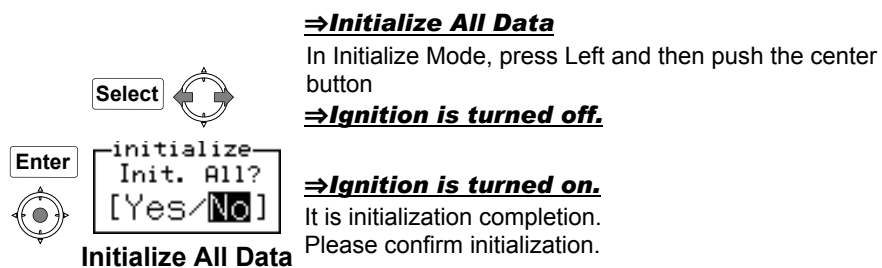

⇒Exit Initialize Mode Without Changes

While in Initialize Mode,

- Select [No] and push center button
- Select [No] and push Right
- Select [Yes] and push Left

This will return user to previous menu.

Etc Mode

Troubleshooting

Power will not

- **Is the battery connected?**
- **Are the ECU harness and signal harnesses connected?**
- **Is the RSM harness and signal harnesses connected?**

Fault connections can occur even when the harnesses seem to be connected. Double check all connectors, splices, and plugs.

Unit does not display properly

- **Speed/RPM does not appear on screen**

Have the two signal wires been properly connected to the ECU? Double check the instruction manual and wiring diagram. Also check for loose connections.

- **RPM display is Incorrect**

- Re-check Cylinder Setting (P13)
- There will be a slight difference in readings from the factory tachometer. It is normal for a 200-300 rpm difference in the higher rpm ranges. This unit will show correct RPM.

- **Speed Display is Incorrect**

- Re-check Speed Pulse Setting and Speed Pulse Adjust Setting (not required on some vehicles) (P13 - 14)
- Factory Speedometers have some level of display error. At 100km/h, it is not unusual for there to be over a 10km/h difference. This unit will display the correct vehicle speed.
- If the speed does not display above a certain point, there may be another sped limiter device installed on the vehicle already. Be sure to remove that device for proper readings.

- **Acceleration and Power will not display**

- Is the G Sensor connected correctly? The G Sensor (separately sold) must be used for these functions.

Unit does not display properly (cont'd)



●Acceleration Display is incorrect

- Has the G Sensor been calibrated?
- Has the G Sensor been installed correctly?

●Power Measurement is incorrect

- Has the vehicle weight been input correctly? (P50)
- Has the G Sensor been calibrated? (P52)
- Has the G Sensor been installed correctly?
- Has Loss Power been input? (P43)

Display is Dark, Bright



- Please adjust VFD screen (P51)

Speed Limiter will not Cut



- Has the speed limiter been cut properly?
Settings differ according to vehicle. Re-check settings (P13 - 14)

Etc Mode

Caution

1. We reserve the right to change any part of this manual without prior notice.
2. We have made every effort possible to make this manual as accurate as possible. However, we assume no responsibility for any errors resulting from typographical, model changes, regional differences, or other factors that may cause improper function.
3. This manual may not be reproduced in any manner without the expressed written consent of Apex.
4. We assume no responsibility for any loss of data in the unit caused by memory failure, unit damage, or any other cause.
5. Prices are subject to change without prior notification.
6. This product is designed for Japan use only. It must not be used in any country unless endorsed by an authorized Apex Sales office. We assume no responsibility for units purchased outside Apex jurisdiction.

-
- All names and product names are the property of Apex
 - This manual is up to date as of Mar.27.2008

Unit Specifications

- Operating Voltage DC11V~16V
- Operating Temp -20~+60°C
- Output Voltage 12V200mA

Manual Info

No	Print Date	Manual Code	Ver.	Notes
3	12-12-2003	7407-0240-01	Ver.3	
4	7-1-2005	7407-0240-02	Ver.4	
5	12-1-2005	7407-0240-03	Ver.5	
6	4-15-2007	7407-0240-04	Ver.6	
7	3-27-2008	7407-0240-05	Ver.7	

Apex Co.,Ltd.

5-21-3 Fujimi SagamiharaCity,Kanagawa,229-1125 Japan.
Tel :+81-42-768-8148 Fax:+81-42-768-8072
URL <http://www.apexi.co.jp/>

Apex Integration Inc.

1449 West Orange Grove Avenue, Suite#A,Orange, CA 92868, USA
Tel :+1-714-685-5700 Fax:+1-714-685-5701
URL <http://www.apexi-usa.com/>

Apex Pac Co.Pte.Ltd.

163, Pasir Panjang Road,Pasir Panjang District Park,#01-20,Singapore 118498.
Tel :+65-6257-5977 Fax:+65-6755-1497
URL <http://www.apex-pac.com/>