



**Cat. No. H8861 Model: RCL-S-STAT**  
**INSTALLATION AND OPERATION INSTRUCTIONS**

**IF YOU CANNOT READ OR UNDERSTAND THESE INSTALLATION INSTRUCTIONS DO NOT ATTEMPT TO INSTALL OR OPERATE**

**INTRODUCTION**

This remote control system was developed to provide a safe, reliable, and user-friendly remote control system for gas heating appliances. The system can be operated thermostatically or manually from the transmitter. The system operates on radio frequencies (RF) within a 20-foot range using non-directional signals. The system operates one of 1,048,576 security codes that are programmed into the transmitter at the factory; the remote receiver's code must be matched to that of the transmitter prior to initial use.

Review **COMMUNICATION SAFETY** under the **TRANSMITTER** section. This safety feature provides an extra margin of safety when the transmitter is out of normal 20-foot operating range.

The transmitter operates on (2) AAA size 1.5DCV batteries. It is recommended that **ALKALINE** batteries always be used for longer battery life and maximum operational performance. **IMPORTANT:** New or fully charged batteries are essential for proper operation of the multi-function transmitter. Insert (2) AAA size 1.5DCV batteries into the battery compartment on the back of the transmitter, positioning the (+) and (-) ends of the batteries as indicated on the casing. When the batteries are inserted, the screen in figure 2 (with similar numbers) will display.

**Note:** If a LOW battery icon appears on the screen, check the position of the batteries.

**CAUTION:** Due to the sensitive temperature-monitoring components in the transmitter, it may be necessary to allow the transmitter to stabilize to room temperature before accurate room temperatures are displayed on the screen. If the transmitter is activated from a severe cold condition, it can take up to fifteen minutes for accurate temperature readings to appear.

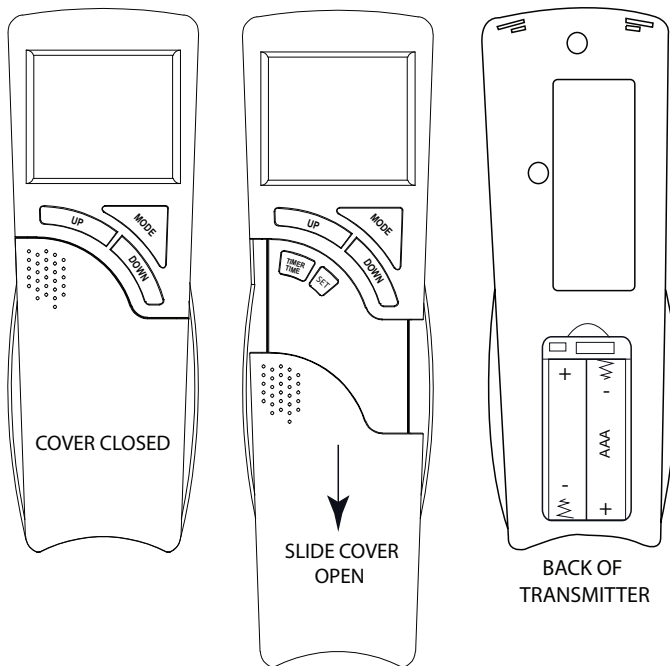

Fig. 1 Transmitter Front and Back Views

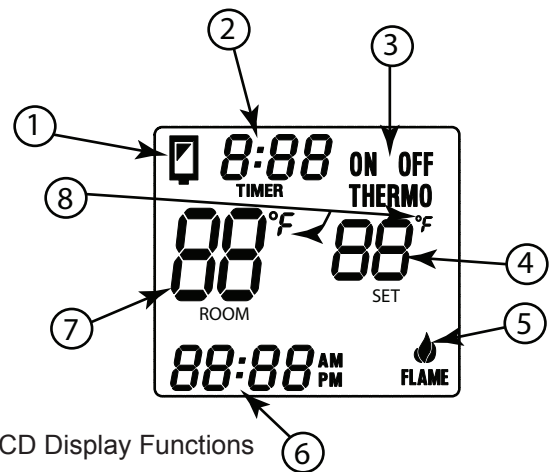

Fig. 2 LCD Display Functions

**LCD DISPLAY FUNCTIONS**

1. **BATTERY ICON** - Symbol means battery power is low. Replace batteries within 2-weeks.
2. **TIMER**- Indicates time remaining before system shuts OFF, when timer-programmed; 9-hour maximum setting.
3. **MODE**- Indicates operation MODE of system. ON indicates the system is manually ON. When screens displays OFF the entire system is turned OFF and THERMO indicates the system will automatically cycle ON/OFF, depending on SET temperature.
4. **SET**- Indicates desire SET room temperature for THERMO operation.
5. **FLAME** – Indicates burner/valve are in the ON position .
6. **CLOCK** – Indicates the current time in AM/PM
7. **ROOM** – Indicates CURRENT room temperature.
8. **°F** indicates degrees Fahrenheit (°C indicates degrees Celsius).

## **BASIC TRANSMITTER FUNCTIONS**

To operate the transmitter, press and release the MODE button (Fig. 3) until the LCD screen reads OFF in the display (Fig. 4).

**Step 1:** Press the MODE button one time to manually turn ON the appliance (Fig. 5).

**Step 2:** Press the MODE button a second time to put the to put the system in THERMO mode (Fig. 6).

**Step 3:** Press the MODE button a third time to turn the appliance back OFF again as show in Fig. 4.

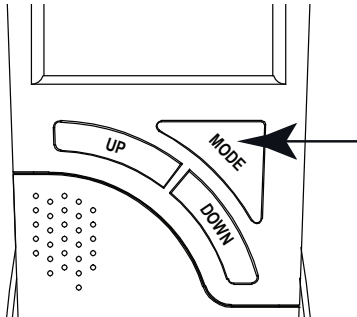

Fig. 3 Mode Button

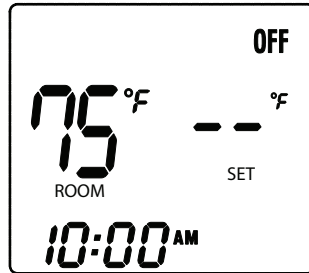

Fig. 4 OFF Mode

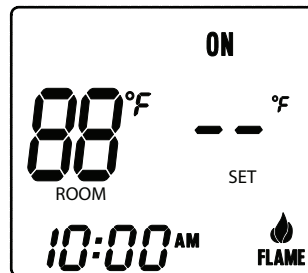

Fig. 5 Manual ON

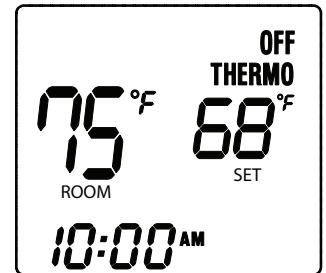

Fig. 6 Thermo Mode

## **SETTING UP THE TRANSMITTER**

Slide down the plastic cover on the front of the transmitter to expose the “TIMER/TIME” and “SET” buttons (Fig. 1). The slide cover protects the buttons from being changed accidentally. Close the cover after completing the settings.

Blinking numbers on the LCD display indicate the system is awaiting user input, such as using the UP and DOWN buttons to program a new setting. If no change is made to flashing digits within 15-seconds, the system will complete the procedure last programmed and reset the display to its normal state.

## **SETTING THE CLOCK**

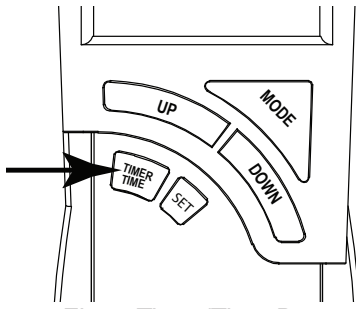

Fig. 7 Timer/Time Button

1. Press and hold the TIMER/TIME button on the transmitter for more than 2-seconds. The hour digit(s) will begin blinking.
2. Press the UP or DOWN button until the desired hour is displayed in AM or PM.
3. After setting the desired hour, press and release the TIMER/TIME button again to set the minutes; the minute digits will begin blinking.
4. Press the UP or DOWN button until the desired minutes are displayed.
5. Press and hold the TIMER/TIME button again for more than 2-seconds. The time digits will cease flashing, indicating the clock has been successfully set. You may also press the SET button on the transmitter to stop the time digits from blinking and set the time.

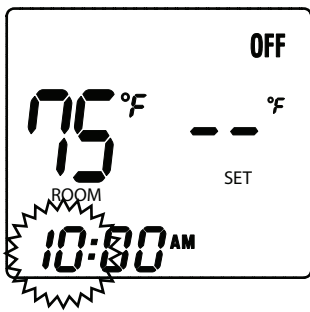

Fig. 8 Setting Hours

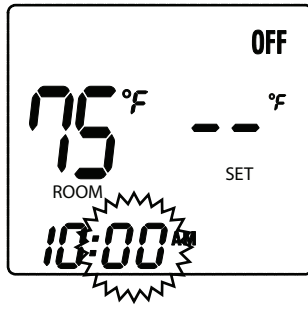

Fig. 9 Setting Minutes

## SETTING °F / °C SCALE

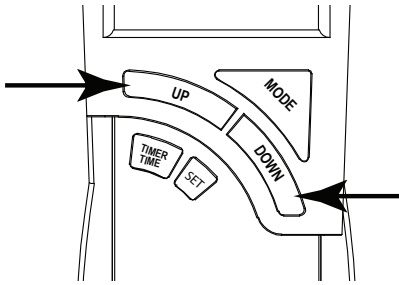

Fig. 10 Temperature Scale

The factory setting for temperature is °F. To change this setting to °C, first press and hold the **UP** and **DOWN** buttons on the transmitter at the same time. Follow this same procedure to change from °C back to °F. When changing between the °F and °C scales, the temperature in the SET frame defaults to the lowest temperature (45° F, or 6° C). The highest SET temperature is 99° Fahrenheit (32° Celsius).

## REMOTE RECEIVER

The remote receiver operates on (4) AA-size 1.5V batteries. It is recommended that **ALKALINE** batteries be used for longer battery life and maximum microprocessor performance. **IMPORTANT:** New or fully charged batteries are essential for proper operation of the remote receiver.

The remote receiver houses the microprocessor that responds to commands from the transmitter to control system operation. It emits one beep when it receives an ON or OFF command manually, but no beep when cycling on and off automatically in THERMO mode. The remote receiver has a 3-position slide switch for selecting the ON/REMOTE/OFF mode of operation:

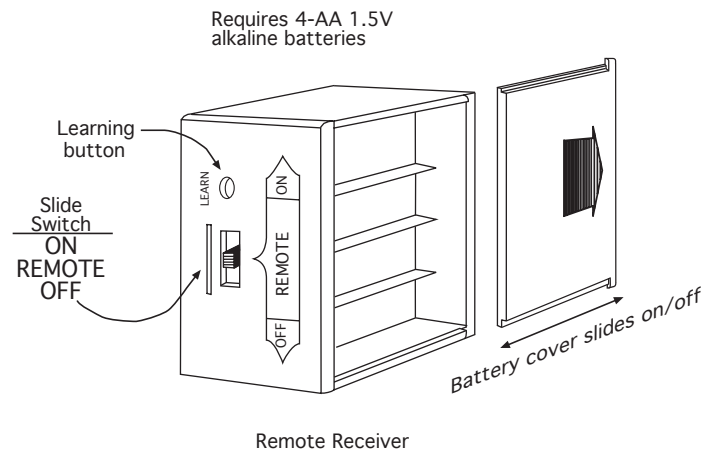

Fig. 11 Remote Receiver

- With the slide switch in the **ON** position (toward the LEARN button), the system will remain **ON** until the slide switch is placed in the **OFF** or **REMOTE** position.
- With the slide switch in the **REMOTE** position (centered), the system will only operate if the remote receiver receives commands from the transmitter.
- With the slide switch in the **OFF** position (away from the LEARN button), the system is **OFF**.
- It is suggested that the slide switch be placed in the **OFF** position if you will be away from your home for an extended period of time. If the remote receiver is mounted out of children's reach, placing the slide switch in the **OFF** position also functions as a safety "lock-out" by both turning the system off and rendering the remote receiver inoperative.

## INSTALLATION PRECAUTIONS

### **WARNING**

This remote control system must be installed exactly as outlined in these instructions. Read all instructions completely before attempting installation. Follow instructions carefully during installation. Any modifications of the remote control or any of its components will void the warranty and could cause a fire hazard.

Do not connect any gas valve or electronic module directly to 110-120VAC power. Consult gas appliance manufacturer's instructions and wiring schematics for proper placement of all wires. All electronic modules are to be wired to manufacturer's specifications.

The following wiring diagrams are for illustration purpose only. Follow instructions from manufacturer of gas valve and/or electronic module for correct wiring procedures. Improper installation of electric components can cause damage to electronic module, gas valve and remote receiver.

## INSTALLATION INSTRUCTIONS

The remote receiver can be **Wall Mounted** into a standard plastic switch box or (**Hearth Mounted**) placed on or near the fireplace hearth. Determine where you will install the receiver before proceeding. Preferably, the remote receiver should be wall-mounted in a plastic switch box, as this will protect its electronic components from both the heat produced by the gas appliance and potential damage or abuse that can occur if it is left exposed on the hearth. PROTECTION FROM EXTREME HEAT IS VERY IMPORTANT. Like any piece of electronic equipment the receiver should be kept away from temperatures exceeding 130°F inside the receiver case. Battery life is also significantly shortened if batteries are exposed to high temperatures.

When installing the receiver into a switch box away from the appliance ensure the receiver switch is in the **OFF** position before installing. The receiver comes standard with 18-inches of wire if additional wire is needed it is recommended that 18-gage stranded or solid wires (not included) be used to make connections between the terminal wiring block on the millivolt gas valve or electronic module and the wire terminals on the remote receiver. For the best results, use 18-gage stranded or solid wire, splice into the black wires of the receiver or remove the black wires and install wires directly to the receiver. Be sure no splices measure longer than 20-feet and allow ample wire to remove the receiver for annual battery replacement.

### WALL MOUNTING

**First**, install (4) AA-size 1.5 **ALKALINE** batteries in the remote receiver (Fig 11). For best performance, remote receiver batteries should be factory fresh when installed. The system operates best when battery output is greater than 5.3 volts. Four (4) new AA batteries should provide an output voltage of 6.0 to 6.2 volts. **Be sure batteries are installed with the (+) and (-) ends facing the correct direction.**

**Next**, attach wall mount cover plate to receiver box (Fig. 12):

Position the receiver as shown in the diagram to the left with lower tab on wall mount cover plate inserted into groove of receiver. Move the receiver up and snap into top tab of cover plate.

Position the cover plate so the word **ON** is facing up (Fig. 13); then, install the remote receiver into the plastic switch box using the two long screws provided. Push the slide button over the receiver slide switch only after making sure the remote receiver has **LEARNED** the transmitter's security code (see **LEARNING TRANSMITTER TO RECEIVER**).

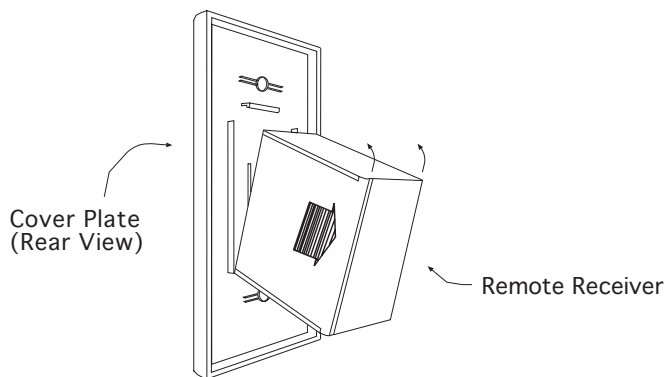

Fig.. 12. Wall plate to Receiver

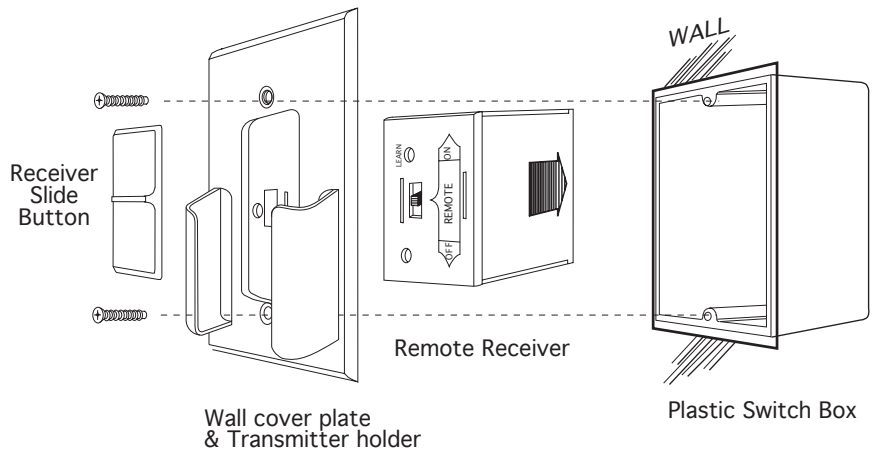

Fig. 13. Installing receiver into switch box.

**NOTE:** The remote receiver will only respond to the transmitter when the 3-position slide button on the remote receiver is in the (middle) REMOTE position. If the system does not respond to the battery transmitter on initial use, see LEARNING TRANSMITTER TO RECEIVER section, and re-check battery positions in the remote receiver.

## HEARTH MOUNT

The remote receiver can be placed on the fireplace hearth or under the fireplace, behind the control access panel or louvers. Position where the ambient temperature inside the receiver case does not exceed 130°F. **NOTE:** Slide Button (included) is used for Hearth Mount applications.

## WIRING INSTRUCTIONS

A qualified electrician or a gas technician who is trained with gas appliances and gas valves that will be operated by this remote should install the remote control system. Incorrect wiring connections WILL cause damage to the gas valve or electronic module operating the gas appliance and may also damage the remote receiver.

### WIRING MILLIVOLT VALVES

The remote receiver must be connected to the millivolt valve at the **TH & TH/TP** (thermostat) terminals on the terminal block on the millivolt gas valve. Connect 18-gage stranded or solid wires from the remote receiver to the gas valve.

Operation of the remote receiver is similar to that of a thermostat in that both turn the gas valve ON and OFF based on input signals. A thermostat's input signals are different temperatures. The remote receiver's input signals come from the transmitter.

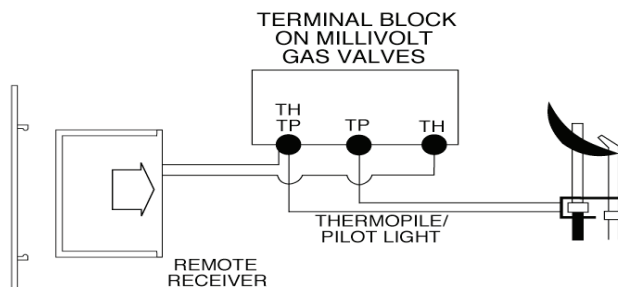

Fig. 14 Millivolt Gas Valve Wiring

Connect one black wire to the **TH** terminal and the other black wire to the **TH/TP** terminals on the millivolt gas valve. Normally it does not matter which wires go to which terminal (Fig. 14).

### WIRING ELECTRONIC SPARK IGNITIONS

The remote control receiver can be connected, in series, to a 24VAC transformer to the **TR** (transformer) terminal on the **ELECTRONIC MODULE**. Connect the hot wire from the 24VAC transformer to either of the wire terminals on the remote receiver. Connect another wire (not included) between the other receiver wire terminal and the **TH** (thermostat) terminal on the **ELECTRONIC MODULE** (Fig. 15).

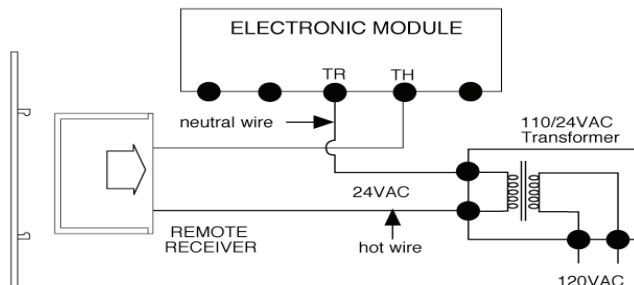

Fig. 15 Electronic Spark Wiring

## LEARNING TRANSMITTER TO RECEIVER

Each transmitter uses a unique security code. It will be necessary to press the **LEARN** button on the receiver to accept the transmitter security code upon initial use, if batteries are replaced, or if a replacement transmitter is purchased from your dealer or the factory. In order for the receiver to accept the transmitter security code, be sure the slide button on the receiver is in the **REMOTE** position; the receiver will not LEARN if the slide switch is in the **ON** or **OFF** position. The **LEARN** button is located on the front face of the receiver; inside the small hole labeled LEARN. Using a small screwdriver or end of a paperclip gently press and release the black LEARN button inside the hole. When you release the LEARN button the receiver will emit an audible "beep". After the receiver emits the beep press the transmitter **MODE** button and release. The receiver will emit several beeps indicating that the transmitter's code has been accepted into the receiver.

The microprocessor that controls the security code matching procedure is controlled by a timing function. If you are unsuccessful in matching the security code on the first attempt, wait 1-2 minutes before trying again – this delay allows the microprocessor to reset its timer circuitry – and try up to two or three more times.

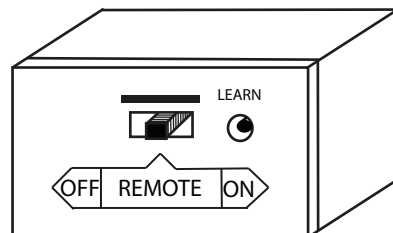

Fig. 16 Learning

## **SYSTEM CHECK**

### **MILLIVOLT VALVES**

Light the gas appliance following the lighting instructions that came with the appliance. Confirm that the pilot flame is **ON**; and the control knob on the gas valve is in the **ON** position for the main gas valve to operate.

- Slide the 3-position button on the remote receiver to the **ON** position (Fig. 16). The main gas flame (fire) should light.
- Slide the button to **OFF**. The flame should extinguish (the pilot flame will remain ON).
- Slide the button to **REMOTE** (the center position), and then press the MODE button on the transmitter to change the system to **ON**. The main gas flame should ignite.
- Press the **MODE** button on the transmitter to change the system to **OFF**. The flame should extinguish (the pilot flame will remain on).
- Press the **MODE** button on the transmitter to change the system to **THERMO**. Advance the SET temperature on the transmitter to a temperature of at least 2°F (1°C) above the ROOM temperature displayed on the LCD screen. With this manual setting, the normal thermostatic cycle is overridden and the system flame will ignite. Place the SET temperature to at least 2°F (1°C) below the room temperature and the system flame will extinguish in a few seconds. Thereafter, it should continue to cycle on and off thermostatically approximately every two minutes as the ROOM temperature changes, but only when the temperature differential between ROOM and SET temperatures differ at least 2°F (1°C). (The 2°F differential is the factory setting.)

### **ELECTRONIC IGNITION SYSTEMS**

- Slide the 3-position button on the remote receiver to the **ON** position. The spark electrode should begin sparking to ignite the pilot (the pilot may ignite after only one spark). After the pilot flame is lit, the main gas valve should open and the main gas flame should ignite.
- Slide the button to **OFF**. The main gas flame and pilot flame should **BOTH** extinguish.
- Slide the button to **REMOTE** (the center position), and then press the **MODE** button on the transmitter to change the system to **ON**. The spark electrode should begin sparking to ignite the pilot. After the pilot is lit, the main gas valve should open and the main gas flame should ignite.
- Press the **MODE** button on the transmitter to **OFF**. The main gas flame and pilot flame should **BOTH** extinguish.
- Press the **MODE** button on the transmitter to change the system to **THERMO**. Advance the SET temperature on the transmitter to a temperature at least 2°F (1°C) above the ROOM temperature displayed on the LCD screen. With this manual setting the normal thermostatic cycle is overridden and the system flame will ignite. Place the **SET** temperature at least 2°F (1°C) below the room temperature and the system flame will extinguish in a few seconds. Thereafter, it should continue to cycle ON and OFF thermostatically approximately every two minutes as the ROOM temperature changes, but only when the temperature differential between ROOM and SET temperatures differ at least 2°F (1°C). (The 2°F differential is the factory setting.)

## **GENERAL INFORMATION**

### **REMOTE RECEIVER**

The remote receiver houses the microprocessor that responds to commands from the transmitter to control the system operation. It emits one beep when it receives an ON or OFF command manually, but no beep when cycling ON and OFF automatically in THERMO mode. The remote receiver has a 3-position slide switch for selecting the MODE of operation: ON/REMOTE/OFF

- With the slide switch in the **ON** position, the system will remain **ON** “manually” until the slide switch is placed in the OFF or REMOTE position.
- With the slide switch in the **REMOTE** position (centered), the system will only operate if the remote receiver receives commands from the transmitter.
- With the slide switch in the **OFF** position, the system is **OFF**.
- It is suggested that the slide switch be placed in the off position if you will be away from your home for an extended period of time. If the remote receiver is mounted out of children’s reach, placing the slide switch in the OFF position also functions as a safety “lock-out” by both turning the system off and rendering the remote receiver inoperative.

## **GENERAL INFORMATION CONTINUED**

### **TRANSMITTER**

#### **TRANSMITTER OPERATING DISTANCE**

The remote control operates on RF (radio frequency) signals that are sent by the TRANSMITTER (remote) to the RECEIVER that operates the appliance. It is recommended that the TRANSMITTER always be located within the 20-foot operating range, preferably in the same room in which the appliance is located.

#### **THERMO UPDATING FEATURE –TRANSMITTER**

This remote control has a THERMO UPDATING Feature built into its software. The THERMO UPDATING Feature operates in the following manner, but only in the THERMO and PROGRAM modes.

The transmitter normally reads the ROOM temperature every 2 minutes; checking the ROOM temperature against the SET temperature by sending a signal to the receiver.

#### **COMMUNICATION – SAFETY – TRANSMITTER – (C/S – TX)**

This series remote controls have a COMMUNICATION – SAFETY function built into the software. It provides an extra margin of safety when the TRANSMITTER is out of the normal 20-foot operating range of the receiver. The COMMUNICATION – SAFETY feature operates in the following manner for all OPERATING MODES: ON/THERMO/OFF.

At all times and in all OPERATING MODES, the transmitter sends an RF signal every fifteen (15) minutes, to the receiver, indicating that the transmitter is within the normal operating range of 20-feet. Should the receiver NOT receive a transmitter signal every 15 minutes, the IC software, in the RECEIVER will begin a 2-HOUR (120-minute) countdown timing function. If during this 2-hour period, the receiver does not receive a signal from the transmitter, the receiver will shut down the fireplace being controlled by the receiver. The RECEIVER will then emit a series of rapid “beeps” for a period of 10 seconds. Then after 10 seconds of rapid beeping, the RECEIVER will continue to emit a single “beep” every 4 seconds until a transmitter signal is again received. The intermittent 4-second beeping will go on for as long as the receiver’s batteries last which could be in excess of one year.

To “reset” the RECEIVER and operate the fireplace system, you must press the MODE button on the transmitter. The word ON must display on the LCD screen. By turning the system to ON, the COMMUNICATION SAFETY operation is overridden and the system will return to normal operation depending on the MODE selected at the transmitter. The COMMUNICATION SAFETY feature will reactivate should the transmitter be taken out of the normal operating range or should the transmitter’s batteries fail or be removed.

## ADDITIONAL PROGRAMMING OF THE TRANSMITTER

### SETTING DESIRED ROOM TEMPERATURE

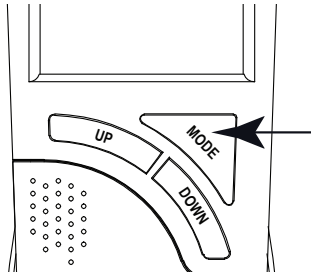

Fig. 17 Mode Button

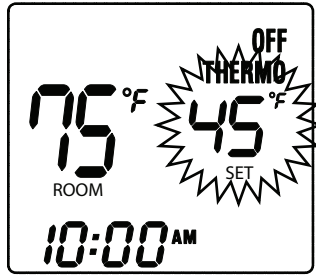

Fig. 18 SET Temperature

This remote control system can be thermostatically controlled when the transmitter is in the THERMO mode (THERMO must be displayed on the screen). To set the DESIRED room temperature, press the MODE button (Fig. 17) to place the transmitter into THERMO mode, then press the UP or DOWN buttons to select the desired room temperature. The highest SET temperature is 99° Fahrenheit (32° Celsius).

**OPERATIONAL NOTE: TO CONSERVE BATTERY POWER, CHANGES IN ROOM TEMPERATURE ARE AUTOMATICALLY UPDATED EVERY TWO MINUTES TO THE TRANSMITTER.**

The Thermo Mode on the transmitter operates the appliance whenever the ROOM TEMPERATURE varies a certain number of degrees from the SET TEMPERATURE. This variation is called the “SWING” or TEMPERATURE DIFFERENTIAL. The normal operating cycle of an appliance may be 2-4 times per hour depending on how well the room or home is insulated from the cold or drafts. A smaller “swing number” increases the number of cycles so the room temperature is more constant. A larger “swing number” decreases the number of cycles, which saves energy, in most cases. The factory setting for the “swing number” is 2. This represents a temperature variation of +/- 2° F (1° C) between SET temperature and ROOM temperature, which determines when the fireplace will be activated. The “SWING” number values are: 1=+ 1° F (.5° C), 2= + 2° F (1° C) and 3 = + 3° F (1.6° C).

### SETTING THE TEMPERATURE SWING (TEMPERATURE DIFFERENTIAL)

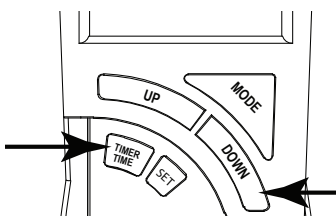

Fig. 19 Timer/Time & Down Buttons

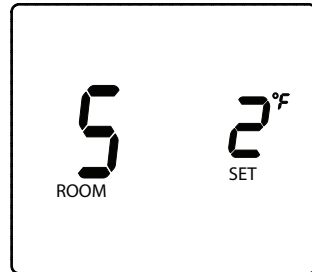

Fig. 20 Swing Temperature

1. To change the temperature “SWING” setting (1-3), press the TIMER/TIME and DOWN buttons simultaneously to display the current “SWING” setting in the SET TEMP frame. The letter “S” will display in the ROOM TEMP frame on the LCD screen.
2. Press the UP or DOWN button to change the temperature differential or “SWING” (1-3). See above for 1-3 “SWING” temperature values.
3. To store the “swing number” press the SET button or allow 15-seconds to lapse, and the new “swing number” will be automatically programmed.

### MANUAL CHECK OF “ SWING” OR TEMPERATURE DIFFERENTIAL

The operation of the factory set “THERMO SWING” can be checked by adjusting the SET TEMP 2° F above or below the room temperature. This will cause the system to turn **ON** or **OFF**. Normally the system will only respond to temperature changes every two minutes. Manually changing the SET temperature will activate the system in less than 10-seconds. If the “SWING” is changed, then a new room temperature differential will respond. Remember the Factory setting of the “SWING” temperature is 2° F.



## SETTING THE COUNTDOWN TIMER

This remote control system can operate with a built-in countdown timer when the transmitter is in the ON or THERMO modes only (THERMO or ON must be displayed on the screen).

1. Press and release the TIMER/TIME button on the transmitter. The word TIMER will appear and 0:15 minutes will begin blinking on the screen (Fig. 21).
2. Press the UP or DOWN button on the transmitter to begin advancing through each of the countdown time options. Available countdown times are 15 minutes, 30 minutes, 45 minutes, 1 hour, 1 hour 30 minutes, 2 hours, 2 hours 30 minutes, and each additional half-hour up to nine (9) maximum hours.
3. To set the TIMER press the SET button on the transmitter if the system is **ON**. It will remain ON until the time has expired. If the system is in the THERMO mode, it will cycle on and off, as the room temperature requires until the “time” has expired.

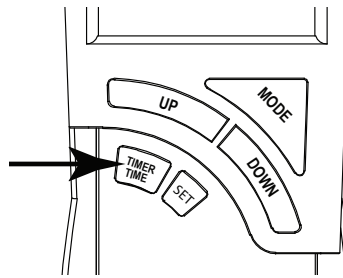
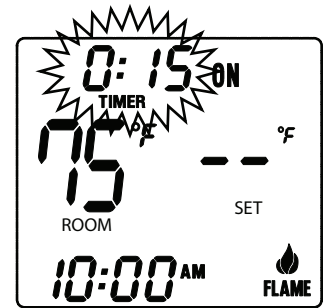

Fig. 21 Setting Timer



**OPERATIONAL NOTE:** When the timer is used in the THERMO mode, the THERMO operation will resume when the “time” has expired.

## LOW BATTERY INDICATOR

A low battery icon will be visible in the upper left corner of the LCD screen when battery power has dropped significantly (Fig. 22). At this time, approximately two weeks of battery power remains until the transmitter may experience partial or complete loss of functions.

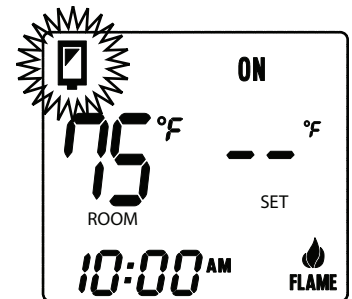

Fig. 22 Low Battery Sign

## CHILDPROOF “LOCK-OUT” – (CP)

This remote control includes a CHILDPROOF “LOCK-OUT” feature that allows the user to “LOCK-OUT” operation of the appliance, from the TRANSMITTER.

### SETTING “LOCK-OUT” – (CP)

1. To activate the “LOCK-OUT” feature, **press and hold** the UP and TIMER/TIME buttons, together, for 5 seconds. The letters **CP** will appear in the TEMP frame on the LCD screen (Fig. 23).
2. To disengage the “LOCK-OUT”, press and hold the UP and TIMER buttons, together for 5 seconds or more, and the letters **CP** will disappear from the LCD screen and the transmitter will return to its normal operating condition.

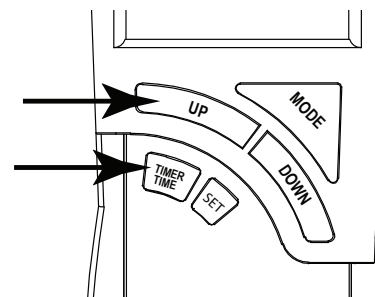
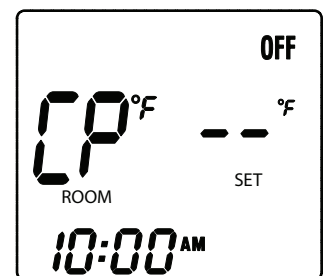

Fig. 23 Child Protection (CP)



**NOTE:** If the appliance is already operating in the ON or THERMO MODES, engaging the “LOCK-OUT” will not cancel the operating MODE. Engaging the “LOCK-OUT” prevents only the manual operation of the TRANSMITTER. If in the auto modes, the THERMO operation will continue to operate normally. To totally “LOCK-OUT” the operation of the TRANSMITTER’S operating signals; the transmitter’s MODE must be set to **OFF**.

## **BATTERY LIFE**

Life expectancy of alkaline batteries should be at least 12-months. Check and replace all batteries annually. When the Transmitter no longer operates the receiver from a distance it did previously (i.e., the transmitter's range has decreased) or the remote receiver does not function at all, the batteries should be checked. It is important that the remote receiver batteries are fully charged, providing a combined output voltage of at least 5.3 volts. The length of the wire between the remote receiver and the gas valve directly affects the operating performance of the remote system. The longer the wire, the more battery power is required to deliver signals between the remote receiver and the gas valve. The Transmitter should operate with as little as 2.5 volts of battery power, measuring at the (2) 1.5-volt batteries.

## **TROUBLE SHOOTING**

Should you encounter problems with your fireplace system, the problem may be with the fireplace itself or it could be with the remote control. Review the fireplace manufacturer's operation manual to make sure all connections are properly made. Then check the operation of the remote in the following manner:

1. Make sure receiver batteries are installed properly. If one battery is installed backward, receiver will not operate in remote mode. Be sure battery output is 2.5 volts or more. (Slide switch is independent of battery condition.)
2. Be sure the transmitter's batteries are properly installed and that the battery output is 2.5V or more.
3. Check to make sure the transmitter is communicating with the receiver.
  - If the receiver beeps when the MODE button is depressed on the transmitter they are communicating.  
**Note:** The receiver only beeps in ON & OFF modes. No beeping occurs from ON to Thermo mode.
  - If the receiver does not beep when the MODE button is depressed on the transmitter, you will need to "learn" (teach) the receiver the code of the transmitter. See page 5 Learning Transmitter to Receiver section.
4. Make sure the transmitter is within the 15 to 20-foot range of the receiver.
5. Positioning of the receiver is important. If the receiver is "enclosed" in a metal surround, the operation of the receiver may be affected as noted below. Reposition the receiver to improve operating range. It is suggested that a heat shield be installed to protect the receiver from extreme heat. If the receiver is "enclosed" in a metal surround, this can:
  - Cause the RF signal to get lost and not communicate with the receiver.
  - Cause the working distance to be shorter than normal.

**NOTE:** A receiver located in an area, where the ambient temperature inside the case exceeds 130°F, will cause THERMO-SAFETY feature to activate, requiring you to reposition the receiver to stop the warning beeps, and to "reset" the receiver's operation.

## **SPECIFICATIONS**

**BATTERIES:** Transmitter 3V (2) ea. AAA 1.5V, Alkaline  
Remote Receiver 6V (4) ea. AA 1.5 Alkaline  
FCC ID No.'s: transmitter –(K9L3003X); receiver – (K9L3003RX)  
Operating Frequency: 303.8MHZ  
Canadian IC ID No.'s: transmitter – 2439-3003X; receiver – 2439A-3003RX

### **FCC REQUIREMENTS**

NOTE: THE MANUFACTURER IS NOT RESPONSIBLE FOR ANY RADIO OR TV INTERFERENCE CAUSED BY UNAUTHORIZED MODIFICATIONS TO THIS EQUIPMENT. SUCH MODIFICATIONS COULD VOID THE USER'S AUTHORITY TO OPERATE THE EQUIPMENT.

### **HOW TO REGISTER A CLAIM AGAINST WARRANTY**

In order for any claim under this warranty to be valid, you must contact the IHP dealer/distributor from which you purchased the product. If you cannot locate the dealer/distributor, then you must notify IHP in writing. IHP must be notified of the claimed defect in writing within 90 days of the date of failure. Notices should be directed to the IHP Warranty Department at 1508 Elm Hill Pike, Suite 108; Nashville, TN 37210 or visit our website at [www.IHP.us.com](http://www.IHP.us.com)