

**MONTIGO**  
the art of **fireplaces**

## Divine Outdoor OUTDOOR RESIDENTIAL GAS FIREPLACE

**H34VO\*,H34VO\*E**  
Natural Gas or Propane Gas

**HL38VO\*,HL38VO\*E**  
Natural Gas or Propane Gas

**H38VO\*,H38VO\*E**  
Natural Gas or Propane Gas

**H42VO\*,H42VO\*E**  
Natural Gas or Propane Gas



### ⚠ CAUTION

Installation and service must be performed by a qualified installer, service agency or the gas fitter. Check local codes and read all instructions prior to installation.

#### ⚠ WARNING: FIRE OR EXPLOSION HAZARD

Failure to follow safety warnings exactly could result in serious injury, death, or property damage.

- Do not store or use gasoline or other flammable vapors and liquids in the vicinity of this or any other appliance.
- WHAT TO DO IF YOU SMELL GAS
  - Do not try to light any appliance.
  - Do not touch any electrical switch; do not use any phone in your building.
  - Leave the building immediately.
  - Immediately call your gas supplier from a neighbour's phone. Follow the gas supplier's instructions.
  - If you cannot reach your gas supplier, call the fire department.
- Installation and service must be performed by a qualified installer, service agency or the gas fitter.

### ⚠ WARNING

**FOR OUTDOOR USE ONLY.**

### ⚠ WARNING

#### CARBON MONOXIDE HAZARD

This appliance can produce carbon monoxide which has no odor. Using it in an enclosed space can kill you. Never use this appliance in an enclosed space such as a camper, tent, car or home.

### NOTICE

**Installer:** Leave this manual with the appliance. Please refer to the Montigo website for the most current version of the fireplaces manual

**Consumer:** Retain this manual for future reference. Please refer to the Montigo website for the most current version of the fireplaces manual

### ⚠ DANGER



**HOT GLASS WILL CAUSE BURNS.  
DO NOT TOUCH GLASS UNTIL COOLED.  
NEVER ALLOW CHILDREN TO TOUCH GLASS.**

A barrier designed to reduce the risk of burns from the hot viewing glass is provided with this appliance and must be installed for the protection of children and other at-risk individuals.

### ⚠ WARNING

Some materials used in the manufacturing process of this product can expose you to Benzene which is known in the State of California to cause cancer and birth defects or other reproductive harm. For more information go to [www.P65warnings.ca.gov](http://www.P65warnings.ca.gov)

# NOTICE

You must read and understand this manual prior to installation, operation or troubleshooting this appliance. Please retain this owner's manual for future reference and maintenance.

## Table of Contents

<b>Introduction</b>	3
Models	3
<b>Installation</b>	
Before you Start	4
Installation Checklist	4
<b>Section 1: Installation Overview and Product Dimensions</b>	5
<b>Section 2: Framing the Fireplace</b>	6
Clearances	6 - 7
Finishing around the Fireplace	7
<b>Section 3: Venting</b>	N/A
<b>Section 4: Wiring</b>	8
Honeywell gas control and pilot	8
<b>Section 5: Installing the Gas Line</b>	9
Section 5-1: Fuel Conversion	9
Section 5-2: Gas Pressure	9
Section 5-3: Gas Connection	9
<b>Section 6:</b>	N/A
<b>Section 7: Installing and Removing the Door</b>	10
<b>Section 8: Installing the Accessories</b>	11 - 14
Installing the H34VON Log Set	11
Installing the H38VON Log Set	12
Installing the H42VON Log Set	13
Installing the HL38VOL Firestones	14
<b>Section 9: Operation</b>	15 - 16
Start-up Sequence with Continuous Pilot	15
Start-up Sequence with Honeywell Electronic Ignition	16
<b>Maintenance</b>	17 - 18
General	17
Cleaning	17
Hi-Lo Burner Adjustment	17
Pilot Burner Adjustment	17
Replacement Parts	18
<b>Appendix</b>	
A. Termination Locations	19
B. Warranty	20
C. State of Massachusetts	21

# NOTICE

**Installer:** Leave this manual with the appliance. Do not remove.

**Consumer:** Retain this manual for maintenance and future reference. Do not Discard.

## Safety Alert Key



### DANGER

Indicates a hazardous situation which, if not avoided, WILL result in death or serious injury or property damage.



### WARNING

Indicates a hazardous situation which, if not avoided, COULD result in death or serious injury or property damage.



### CAUTION

Indicates a hazardous situation which, if not avoided, WILL result in minor or moderate injury.

### NOTICE

Address practices that are important, but not related to personal injury

## Introduction

Congratulations on your purchase of a **Montigo Fireplace**.

With over 30 years of experience, Montigo is committed to providing you with a gas fireplace that is not only a beautiful addition to your space, but that is also designed and manufactured to the highest safety, reliability and engineering standards.

We strongly encourage you to read and carefully follow the instructions laid out in this Installation, Operation and Maintenance Manual and retain it for your future reference. Pay special attention to all cautions, warnings, and notices throughout this manual intended to ensure your safety.

This manual covers installation, operation and maintenance. Lighting, operation and care of this fireplace can be easily performed by the homeowner. All installation and service work should be performed by a qualified or licensed installer, plumber or gas fitter as certified by the state, province, region or governing body where the fireplace is being installed.

This installation, operation and maintenance manual is applicable to the models described below. Refer to your rating plate to verify included options.

### How to use this manual:

This manual covers installation, operation and maintenance. Lighting, operation and care of this fireplace can be easily performed by the homeowner. However, all installation and service work should be performed by a qualified or licensed installer, plumber, or gasfitter who is qualified or licensed by the state, province, region, or governing

body in which the appliance is being installed.

### Warranty and Installation Information: (See Appendix B)

The Montigo warranty will be voided by, and Montigo disclaims any responsibility for, the following actions:

- Modification of the fireplace and/or components including Direct-Vent assembly or glass doors.

- Use of any component part not manufactured or approved by Montigo in combination with this Montigo fireplace system.

- Installation other than as instructed in this manual.

Consult your local Gas Inspection Branch on installation requirements for factory-built gas fireplaces. Installation & repairs should be done by a qualified contractor.

MODEL	Natural Gas	Liquid Propane	Gas Rating (BTU hr)	Traditional Burner	Linear Burner	Standing Pilot Ignition	Honeywell Hot Surface Ignition
H34VON	X		26,000	X		X	
H34VOL		X	26,000	X		X	
H38VON	X		34,000	X		X	
H38VOL		X	34,000	X		X	
HL38VON	X		34,000		X	X	
HL38VOL		X	34,000		X	X	
H42VON	X		40,000	X		X	
H42VOL		X	40,000	X		X	
H34VONE	X		26,000	X			X
H34VOLE		X	26,000	X			X
H38VONE	X		34,000	X			X
H38VOLE		X	34,000	X			X
HL38VONE	X		34,000		X		X
HL38VOLE		X	34,000		X		X
H42VONE	X		40,000	X			X
H42VOLE		X	40,000	X			X

## WARNING

**Hot glass** will cause burns. **Do not touch** glass until unit is cooled. **Never** allow children to touch glass.



# Installation

## IMPORTANT MESSAGE: SAVE THESE INSTRUCTIONS

The Divine Outdoor Ventless fireplace must be installed in accordance with these Instructions. Carefully read all the Instructions in this manual first. Consult the Local Gas Branch to determine the need for a permit prior to starting the installation. It is the responsibility of the installer to ensure this fireplace is installed in compliance with the manufacturers instructions and all applicable codes.

## BEFORE YOU START:

### NOTICE

Installation and repairs should be done by an authorized gas fireplace service technician. The appliance should be inspected before use and at least annually by a professional. More frequent cleaning may be required due to excessive lint from carpeting, bedding material, etc. It is imperative that control compartments, burners and circulating air passageways of the fireplace are kept clean.

### CAUTION

Due to high operating temperatures, this appliance should be located out of traffic & away from furniture and draperies.  
Children and adults should be alerted to the hazards of the high surface temperature, which could cause burns or clothing ignition.  
Young children should be carefully supervised when they are in the same room as the appliance.  
Clothing or other flammable materials should not be placed on or near the appliance.

### DANGER

When this appliance is installed directly on any combustible material other than wood flooring, it must be installed on a metal or wood panel extending the full width and depth of the appliance or a fire will occur causing serious injury, property damage or even death.

## Installation Checklist

- Determine the desired install location of your fireplace.
- See **Section 1**, Dimensions on **Page 5**, and refer to the Framing **Section 2** for details.
- Layout Electrical Requirements Refer to **Section 4: Wiring**, for Details.
- Refer to **Section 5: Installing the Gas Line**, for details on the gas connection and access.
- Refer to local codes and guidelines for installation requirements.
- **Installation and repairs should be done by a qualified contractor and must conform to:**
  - **Installations in Canada** must conform to the current CAN/CGA B-149.1 and .2 Gas Installation Code and local regulations.
  - **Installations in Canada** must conform to the local codes or in the absence of local codes to the current version of Natural Gas and Propane Installation Code, CSA B149. Electrical Installations must conform to the local codes or, in the absence of local codes, to the current version of Canadian Electrical Code, CSA C22.1.1
  - **Installations in the USA** must conform to the local codes or in the absence of local codes to the current version of National Fuel Gas Code, ANSI Z223.1/NFPA 54. Electrical Installations must conform to the local codes or, in the absence of local codes, to the current version of the National Electrical Code, ANSI/NFPA 70. See **Appendix C** for installation within the State of Massachusetts.

### CAUTION

Young children should be carefully supervised when they are in the same room as the appliance. Toddlers, young children and others may be susceptible to accidental contact burns. A physical barrier is recommended if there are at risk individuals in the house. To restrict access to a fireplace or stove, install an adjustable safety gate to keep toddlers, young children and other at risk individuals out of the room and away from hot surfaces.

# Installation



## Section 1: Installation Overview and Product Dimensions

Please review the Installation Checklist for general information on preparing for a successful installation of your fireplace.

The Divine VO fireplace may be installed in any location that maintains proper clearances to air conditioning ducts, electrical wiring and

plumbing. Safety, as well as efficiency of operation, should be considered when selecting the fireplace location. Try to select a location that does not interfere with room traffic, and has adequate ventilation.

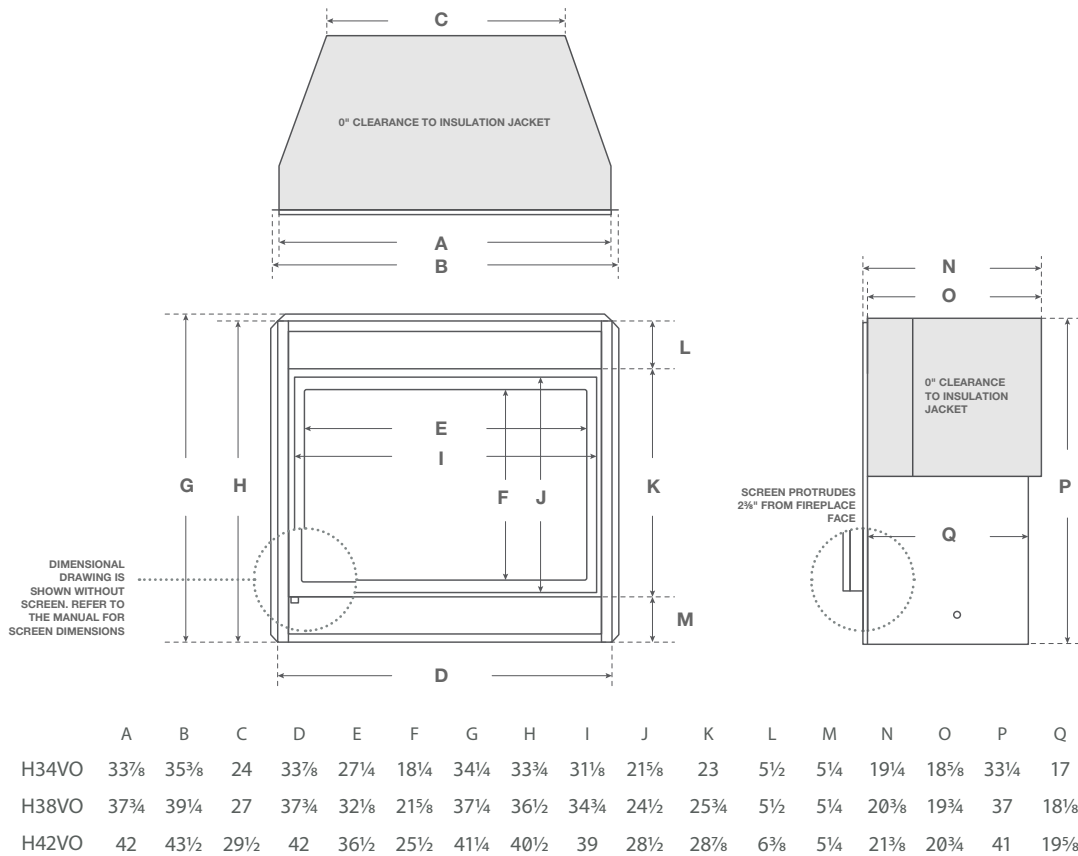

Figure 1. Fireplace dimensions



# Installation

## Section 2: Framing

### Choosing The Fireplace Location

The **Divine Outdoor VO** may be installed in an outdoor setting such as a patio or balcony. Choose a location that maintains proper clearance to combustibles as noted in the clearances chart.

Note: **Divine Outdoor VO** may not be recessed into the exterior wall.

**Note: Minimum 2 side of the covered patio/deck must be open**

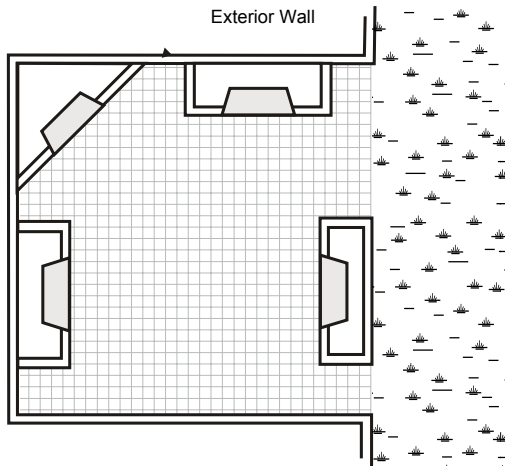

Figure 2. Choosing the fireplace location.

For protection against freezing temperatures, it is recommended that outer walls of the chase be insulated with a vapour barrier. This will reduce the possibility of a cold-air convection current on the fireplace.

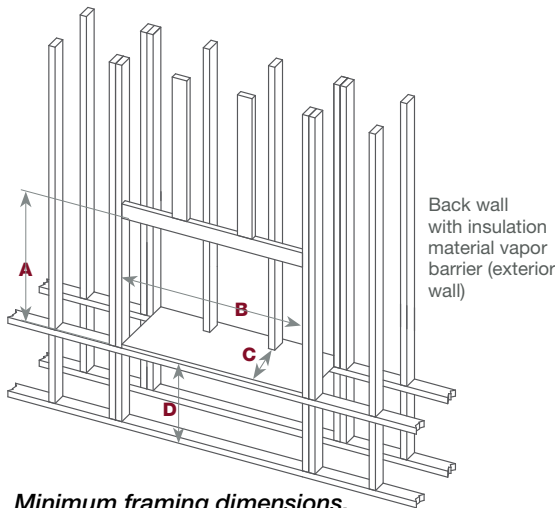

Figure 2.a Minimum framing dimensions.

	A	B	C	D	E	F	G	H
H34VO	38 <sup>3</sup> / <sub>4</sub>	35 <sup>3</sup> / <sub>8</sub>	20 <sup>1</sup> / <sub>4</sub> <sup>†</sup>	12*	61 <sup>1</sup> / <sub>8</sub>	35 <sup>3</sup> / <sub>8</sub>	0	43 <sup>3</sup> / <sub>8</sub>
H38VO	42 <sup>1</sup> / <sub>2</sub>	39 <sup>1</sup> / <sub>4</sub>	21 <sup>3</sup> / <sub>8</sub> <sup>†</sup>	12*	65 <sup>3</sup> / <sub>8</sub>	39 <sup>1</sup> / <sub>4</sub>	0	49 <sup>9</sup> / <sub>16</sub>
H42VO	46 <sup>1</sup> / <sub>2</sub>	43 <sup>1</sup> / <sub>2</sub>	22 <sup>3</sup> / <sub>8</sub> <sup>†</sup>	12*	72 <sup>1</sup> / <sub>4</sub>	43 <sup>1</sup> / <sub>2</sub>	0	51 <sup>1</sup> / <sub>8</sub>

Be sure to plan a drain system for both in the wall and standalone installations.

\*Measurement above grade for US installations

<sup>†</sup>Dimension is to back wall or back studs

### Warning:

When covering the upper metal portion of the fireplace with a non-combustible material Please Note: The decorative facing materials may be subject to temperatures in excess of 250° F. This should be considered when selecting facing materials.

Please be aware; temperatures over the mantel will rise above normal room temperature and walls above fireplace may be hot to touch.

We recommend careful consideration be given to the effects of elevated mantel temperatures which may be in excess of product design, for example: candles, plastic or pictures.

When installing a shelf over the top of the fireplace, the minimum clearance from the top of the fireplace to a shelf is 9".

When raising the hearth, the minimum clearance from the top of the fireplace to a combustible ceiling is 36".

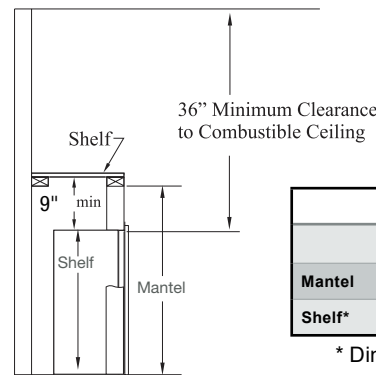

\* Dimension plus height of shelf.

Figure 2b. Framing for shelves over the fireplace.

### Clearances

The **Divine Outdoor VO** clearances to combustibles are listed below and are the **minimum** clearances to combustibles that apply to the following dimensions:

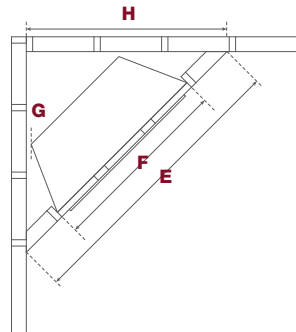

Figure 3. Minimum Corner framing dimensions.

## Important

If the Optional drain pan is not used during construction; (as shown in Figure 2a above) ensure any water build-up can escape to the exterior of the finished enclosure.

Water penetration can occur, and accumulate in the base of the fireplace, and if not taken into consideration can cause deterioration of materials, and may cause premature failure of the structure.

# Installation



Clearances			
	H34VON	H(L)38VO	H42VON
Top	9"	9"	9"
Header	5½"	5½"	5½"
Sides	1"†	1"†	1"†
Floor	0"	0"	0"
Back	1"†	1"†	1"†
Mantel	12"	12"	12"
Ceiling	36"	36"	36"

†Clearance to insulation jacket is 0"

## Mantels & Surrounds

**NOTE:** National Canadian Gas Association mantel test requirements are for fire hazard prevention to combustible materials.

New technology, to meet consumer and government demands for the wise use of energy, has prompted us to manufacture many models of fireplaces which are hot, fuel and energy efficient.

## Finishing Around the Fireplace

All fireplace facing must be non-combustible. Non-combustible mantels and mouldings may be safely installed over the top and on the front of the fireplace provided that they do not project beyond shaded area shown in **Figure 3**. Side wall clearances are 3". Only non-combustible surrounds may be installed around and on the facing of the fireplace as shown in **Figure 3b**.

\* Shaded area must be non-combustible. Either Montigo supplied nailing flange, and cement board or other equivalent non-combustible material.

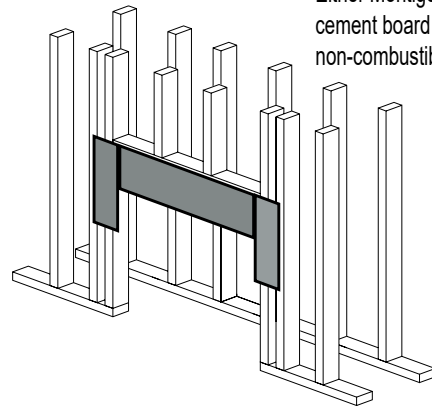

Figure 3a. Non-combustible facing Material

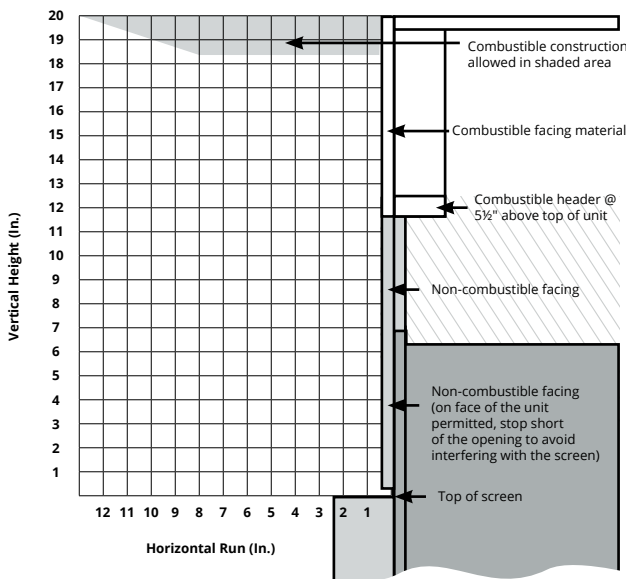

Figure 3. Non-combustible mantles and facings.

## Fireplace Facing

When selecting the finish material for your fireplace, it is important to remember the following: **THE LOWER GAS CONTROL PANEL MUST NOT BE OBSTRUCTED IN ANY WAY - to do so restricts the air supply for the control compartments and heat exchanger it also prevents access for servicing controls.**

Decorative facing must not extend past the fireplace opening at all, because it will interfere with the access to retainers for removal of glass door.

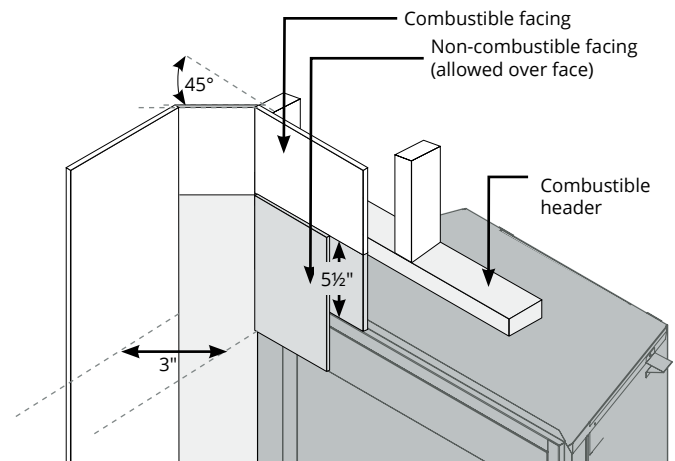

Figure 3b. Non-combustible surrounds and sidewall clearances.

## **WARNING:**

When this appliance is installed directly on any combustable material other than wood flooring, it must be installed on a metal or wood panel extending the full width and depth of the appliance.



# Installation

## Section 4: Wiring

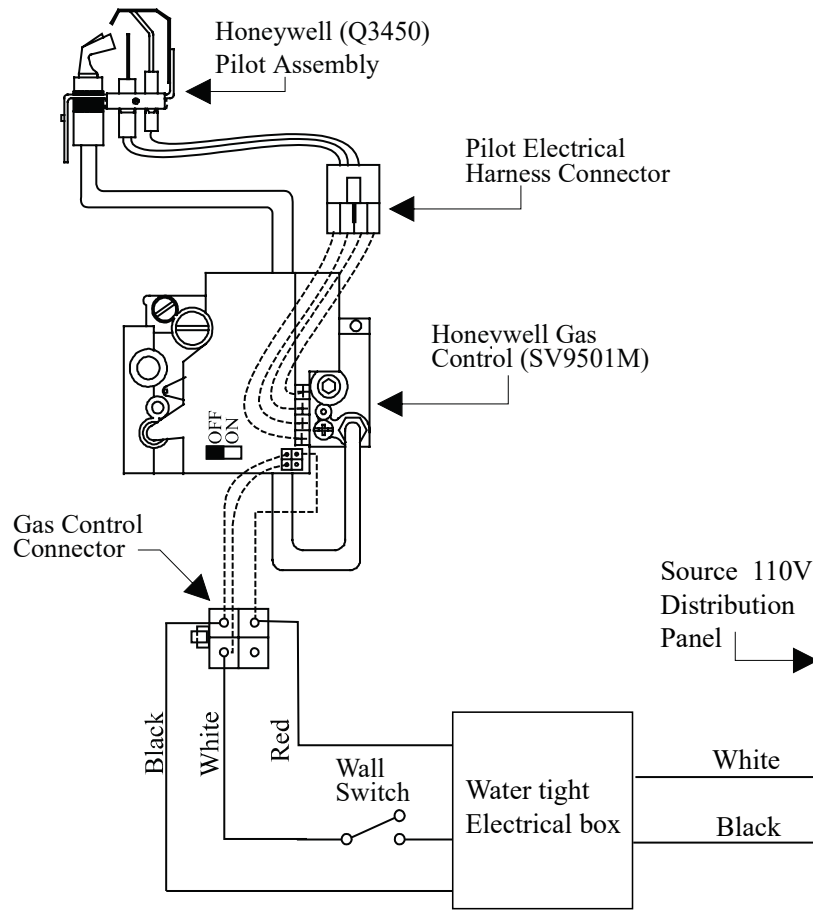

Figure 4. Wiring for the Divine Outdoor VO Honeywell gas control and pilot.

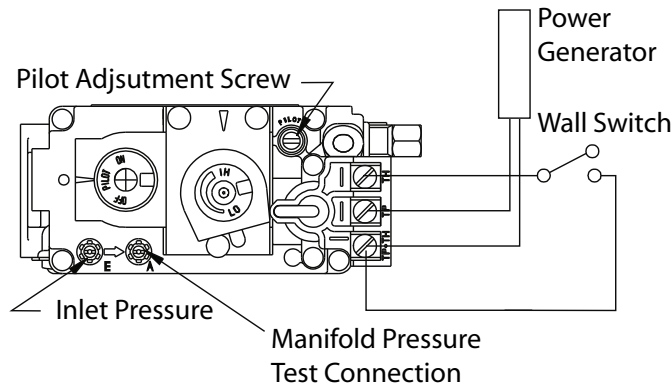

Figure 4a. Standing Pilot Diagram

### Installing The Remote Switch

The **Divine Outdoor's** gas valve, located behind the lower trim, may be connected to a wall switch. The valve generates its own power on **a millivolt circuit. Use only low voltage wire, and DO NOT** connect any external power to it.

Refer to **Figure 4** for wiring requirements.

**Note:** The switch location must not exceed 30' from the fireplace.

### **WARNING!**

Montigo Part No. #RPOVO must be encased in a water-tight electrical box OR ensure the box is installed in a dry location and avoid any moisture. If installed outdoors, ensure you also install a Ground Fault Interrupt per local code.



# Installation



## Section 5: Installing the Gas Line

### Section 5-1: FUEL CONVERSION

- Verify that your fireplace is compatible with your available gas type. (Natural Gas or Propane shown by "N" or "L" in your model number)
- If gas type is not compatible, contact your local Montigo representative to purchase a conversion kit.
- Conversion kits must be installed by a qualified service technician.

### Section 5-2: GAS PRESSURE

- Optimum appliance performance requires proper input pressures.
- Gas line sizing requirements will be determined in ANSI Z221.3 National Fuel Gas Code in the USA and CAN/CGA B149 in Canada.

Pressure requirements are:

Gas Pressure	Natural Gas	Propane
Minimum inlet pressure	5.5in. w.c.	11in. w.c.
Manifold pressure	3.5in. w.c.	10in. w.c.

- The manifold outlet pressure is set from the factory to the appropriate pressure but should be verified.
- To check pressures, control valves have a provision to remove a 1/8" N.P.T. plug to be fitted with a hose barb.
- Montigo requires a service shut off valve be located in an accessible location to isolate the gas supply.
- Only install gas shut-off valves approved for use by the state, province, or other governing body in which the fireplace is being installed.

### Section 5-3: GAS CONNECTION

- See **Figure 5** below for location of gas line access.
- Flexible gas connectors must not exceed 3 feet in length, unless allowable within local regulations.
- Connect incoming gas line to the 1/2" or 3/8" gas inlet port.
- Purge all air out of gas line.
- Check appliance connection, valve and valve train under normal operating pressure with a commercially available leak check solution.
- **DO NOT USE A FLAME OF ANY KIND TO TEST FOR LEAKS.**

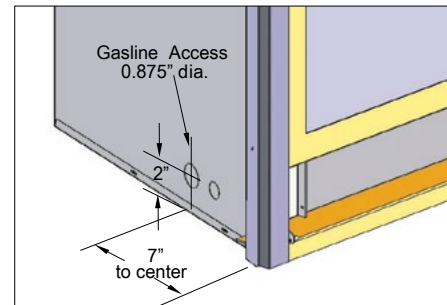

Figure 5. Gas line access.

**Note:** After gas line is connected, **each appliance connection, valve and valve train** must be checked while under normal operating pressure with either a liquid solution, or leak detection device, to locate any source of leak. Tighten any areas where bubbling appears or leak is detected until bubbling stops completely or leak is no longer detected. **DO NOT use a flame of any kind to test for leaks.**

## **WARNING!**

When pressure testing the fireplace, Gas line, and input system follow the appropriate local codes or your area. **DO NOT** connect the fireplace to pressures in excess of 1/2lb. This will damage the gas control valve.



# Installation

## Section 7: Installing & Removing the Door

### Removing the door:

The **Divine Outdoor VO** doors are removed in a few simple steps. Follow these below to remove the Horizontal access panel, unlatch the door buckles and, remove the door. Replace in reverse order.

#### Remove the Horizontal Access Panel:

##### Step 1: Remove the Horizontal Access Panel:

Remove the Horizontal cover by placing fingers in both finger holes, then pushing away from you and lifting out. Place it aside during maintenance or cleaning. Install in reverse order.



Figure 7. Removing and installing the Horizontal Access Panel

##### Step 2: Locate the Door Buckles:

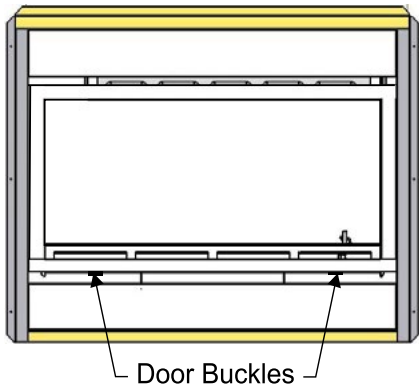

Figure 7a. Locate the door buckles. (Both Sides Typical)

##### Step 3: Release the Door Buckles



Figure 7b. Door buckle Tool

##### Step 4:

Firmly grasp hand-hold end of Door buckle tool and place the machined end in the slot under door frame. (as shown)

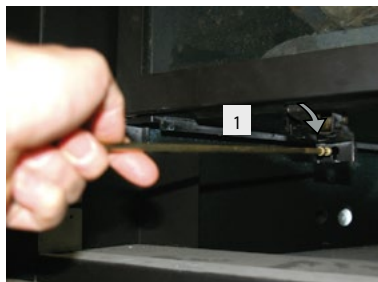

Figure 7c.

##### Step 5:

Ensure the tool is firmly in the lower end of the slot, (as shown), Then pull toward you (Caution: hold the tool securely).

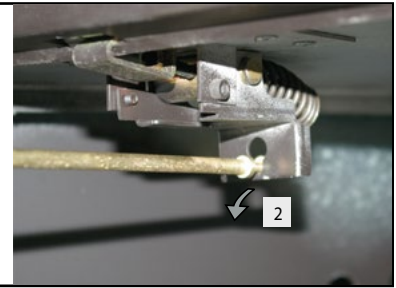

Figure 7d.

##### Step 6:

Pull hard if necessary to release the spring tension. (Caution: The latch springs back with force, hold the tool securely).

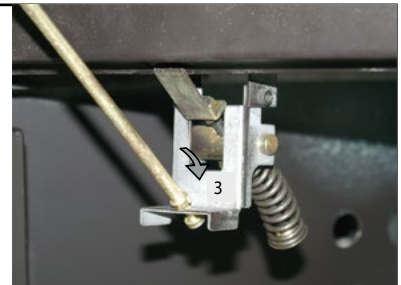

Figure 7e.

##### Step 7:

Remove the tool from the latch slot. Ensure the latches are hanging freely, the hook end is released from the bottom of the door. (Repeat all 4-steps for the remaining latches).

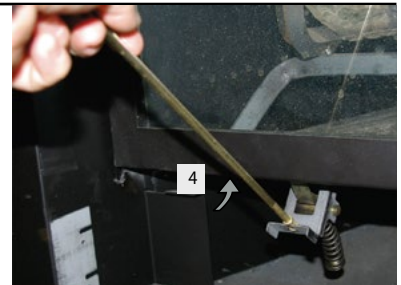

Figure 7f.

##### Step 8: Removing the Door:

Grasp the Door on either side, usually midway and lift upward, lift the door carefully up and away from the front of the fireplace. See **Figures 7g.** Place the Door aside in a safe place while maintenance and / or cleaning is being performed.

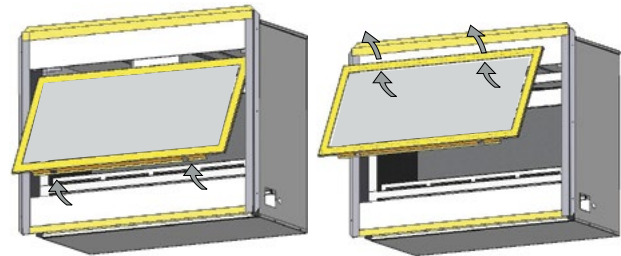

Figure 7g. Removing and installing the glass doors. (Both Sides Typical)

##### Installing the Door:

To install the door, hook the top edge of the door frame into place. Lower the door into position and follow the previous steps shown in reverse order.

# Installation



## Section 8: Installing the Accessories

### Installing the H34VON Log Set

#### Installing the Logs:

The H34VON fireplace is supplied with five ceramic fibre logs. Unpack the logs and handle them very carefully.

**Step 1.** Remove the glass door as described in the previous instruction.

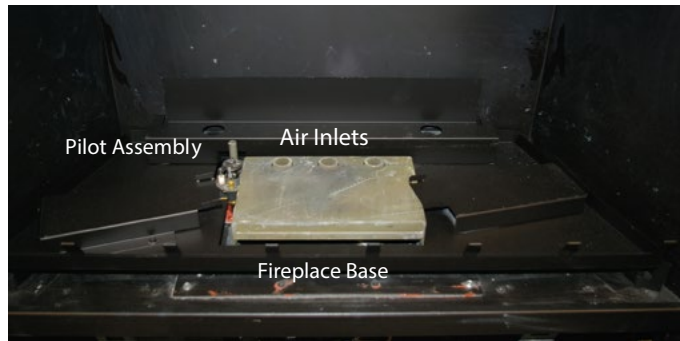

Figure 8a. H34VON's Fireplace Base.

**Step 2.** Install Bottom Rear log as shown in **Figure 8b**.

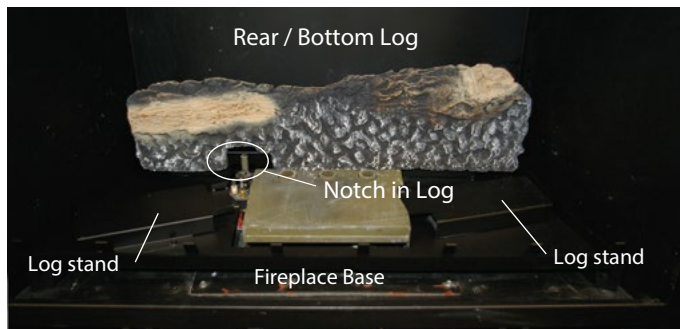

Figure 8b. Bottom/Rear log placement.

**Step 3.** Install Both front base logs, (**Figure 8c**) on the log stands provided. See **Figure 8b**.

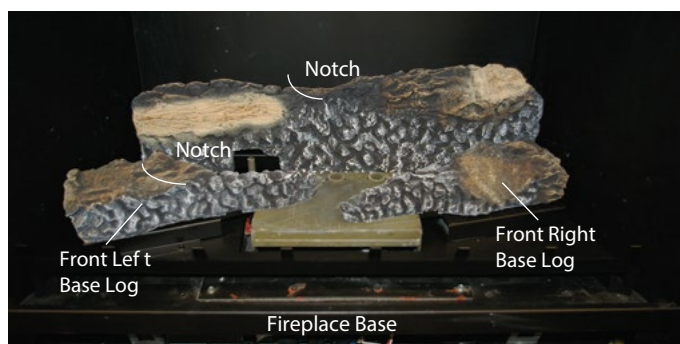

Figure 8c. Front base logs placement.

**Step 4.** Place the top left log as shown in **figure 8d**. A flat area is provided on the front left log, and a notch in the Rear bottom log, as shown in **figure 27c**. Install the glass door. If the flame does not appear satisfactory, double-check the air inlet and exhaust outlet pipe to ensure that they are unobstructed.

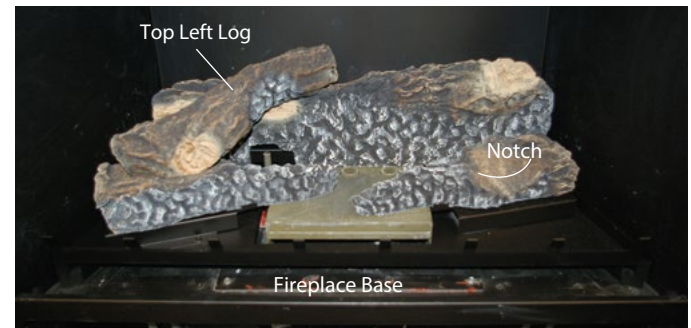

Figure 8d. Top Left log placement.

**Step 5.** Place the top right log as shown in **figure 8e**. A notch is provided on the front right log, and a impression in the Rear bottom log.

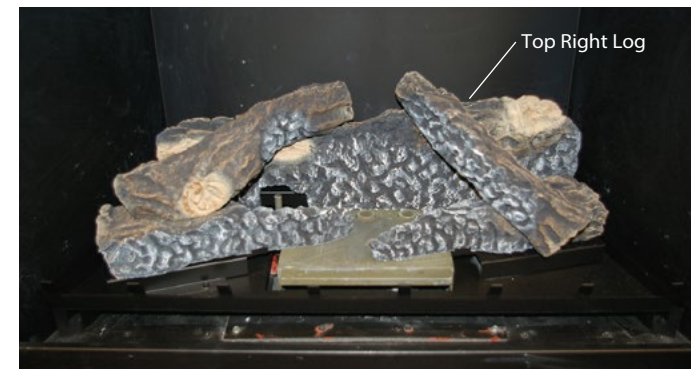

Figure 8e. Top right log placement.

**Step 6.** Start the fireplace. If the flame appears satisfactory, replace the glass door. If the flame does not appear satisfactory, double-check the air inlet and exhaust outlet pipe to ensure that they are unobstructed.

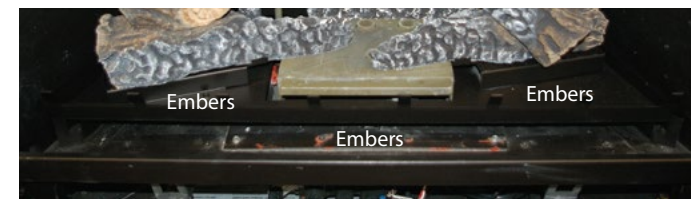

Figure 8f. Placing Embers.

**Step 7.** Place the Embers as shown in **figure 8f**. Arrange the ember chips on top of the burner tray. Care should be taken when placing the embers, as blocked burner ports may cause an incorrect flame pattern, carbon deposits and delayed ignition. Also, the embers must never be placed in a way that obstructs any of the air inlet ports, located at the rear of the burner, as shown in **figure 8a**.

## NOTICE

If logs are not placed properly, excessive sooting will result.



# Installation

## Installing the Log set:

The H38VON are supplied with a six ceramic fibre log logset. Unpack the logs and handle them very carefully.

**Step 1.** Remove the glass door as described in the previous Instructions.

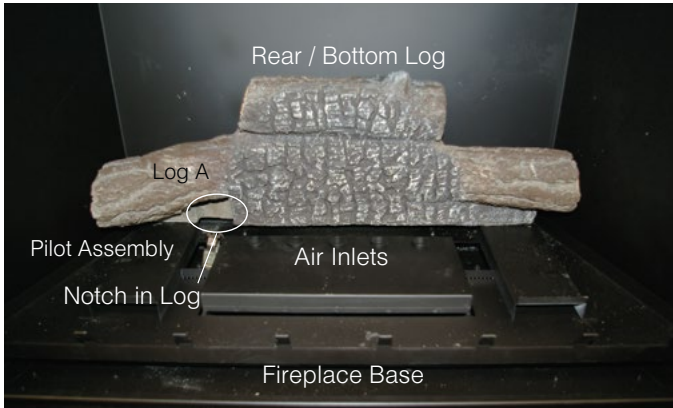

**Figure 9a. Bottom Rear Log, (Log A).**

**Step 2.** Place the bottom Rear log (Log A) as shown in **figure 9a**.

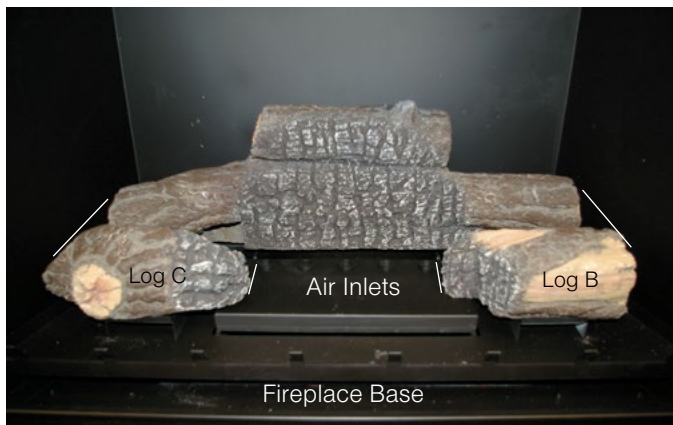

**Figure 9b. Left front Log, (Log C) and Right front Log, (Log B).**

**Step 3.** Place the bottom Right log (Log B) and bottom Left Log, (Log C) as shown in **figure 9b**.

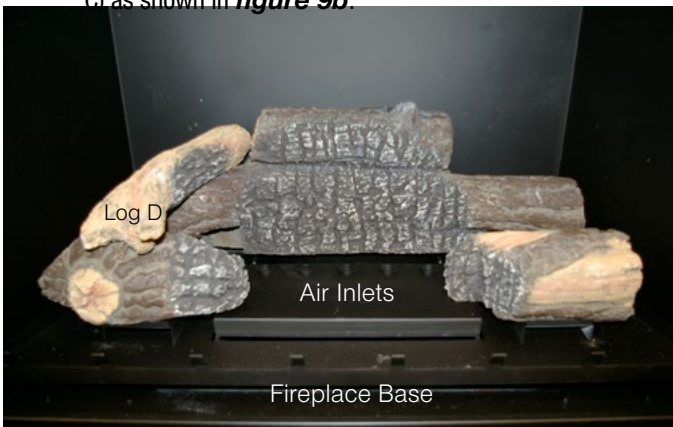

**Figure 9c. Top Left Log, (Log D).**

**Step 5.** Place Front Left log (Log D) as shown in **figure 9c**.

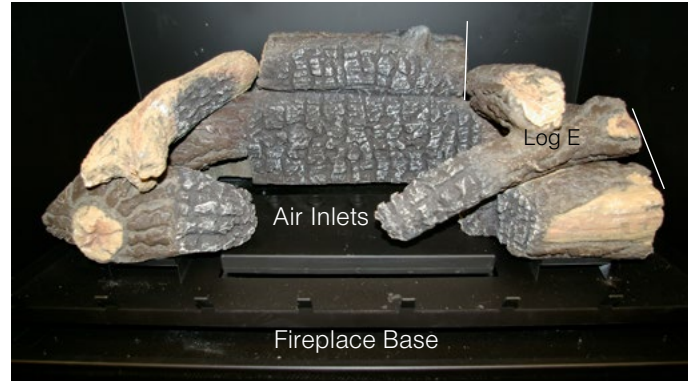

**Figure 9e. Top Right Log, (Log E)..**

**Step 6.** Place Front Right log (Log E) as shown in **figure 9e**.



**Figure 9f. Front Left Log, (Log F).**

**Step 7.** Place Front Left log (Log F) as shown in **figure 9f**. Set notch in lower end of Log F against stile on Log Grate.



**Figure 9g. Completed Logset.**

## NOTICE

If logs are not placed properly, excessive sooting will result.

# Installation



## Installing the Log set:

The H42VON\* is supplied with a seven ceramic fibre log logset. Unpack the logs and handle them very carefully.

**Step 1.** Remove the glass door as described in the previous instructions.

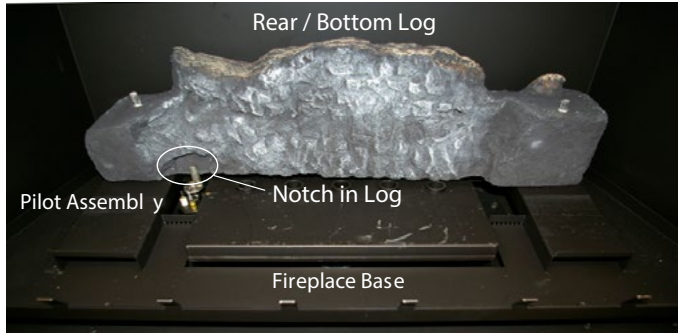

**Figure 10a. Placing Bottom Rear Log.**

**Step 2.** Place the bottom Rear log as shown in **figure 10a**.

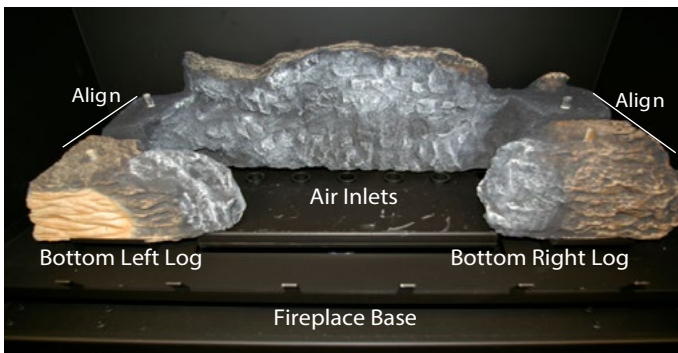

**Figure 10b. Placing Bottom Right / Left Logs.**

**Step 3.** Place the bottom Right and Left logs as shown in **figure 10b**.

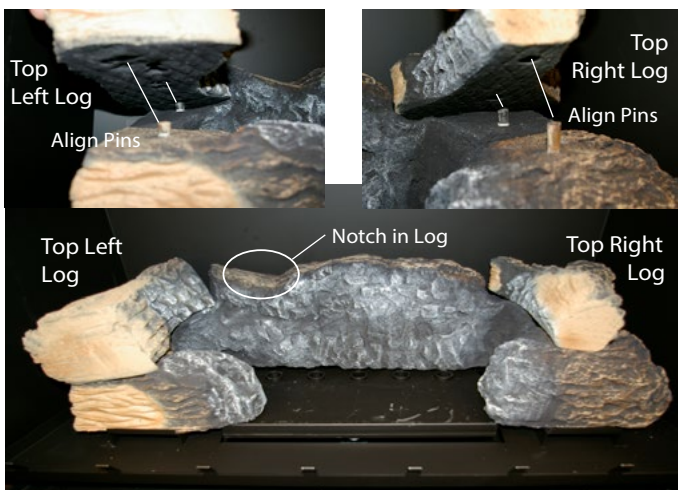

**Figure 10c. Top Left / Right Log.**

**Step 4.** Place the Top Right log as shown in **figure 10c**. using the (4) four alignment pins protruding from the top of the Right and Left Bottom Logs, as shown in **figure 10c**. With these pins align the Top Right and Left logs using the predetermined alignment holes cast into the underside of the logs, as shown above, **figure 10d**.

**Step 5.** Place the Centre Front log, **Figure 10d** below, as shown using the notch cast in the Bottom Rear log as shown in **figure 10c** above.

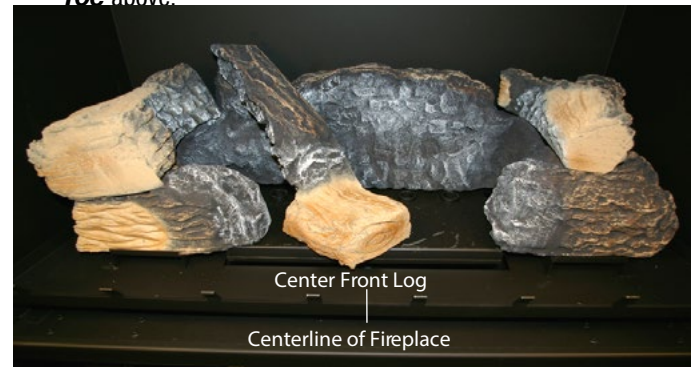

**Figure 10d. Placing Centre Front Log.**

**Step 7.** Place the Right Centre log as shown in **figure 10e**.

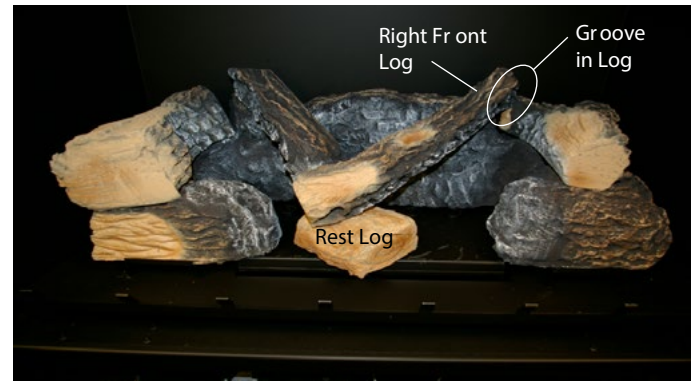

**Figure 10e. Placing Right Center Log.**

**Step 8.** Place the Right Center log as shown using the notch in the Top Right log as a guide, **figure 10f**.

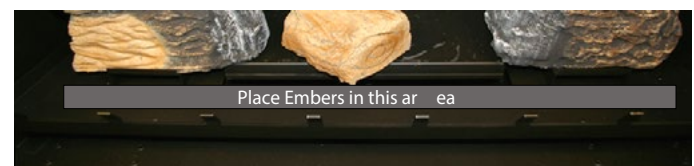

**Figure 10f. Placing Embers.**

**Step 9.** Place the Embers as shown in **figure 10f**.

Arrange the ember chips on top of the burner tray. Care should be taken when placing the embers, as blocked burner ports may cause an incorrect flame pattern, carbon deposits and delayed ignition. Also, the embers must never be placed in a way that obstructs any of the air inlet ports, located at the rear of the burner, as shown in **figure 10b**.

## NOTICE

If logs are not placed properly, excessive sooting will result.



# Installation

## Section:

### Installing the Firestones:

#### N.G. & Propane. Fireplaces

Propane **HL38VOL\*** Fireplaces, has the option of installing the optional cultured rocks or firestones. As described below, **CAUTION**, the firestones or cultured rocks cannot cover the burners. Doing so produces an undesirable / uneven flame pattern, and eventual sooting. Install as shown, **Figure 11 to 11a**.

**⚠ CAUTION!**

**DO NOT COVER THE BURNERS** with firestones



**Figure 11. Completed firestone installation. (Note: DO NOT place ANY firestones on top of the burners).**



**Figure 11a. Operating gas fireplace with firestones surrounding burner tray.**

### Screen Dimensions

Screen Dimensions							
	A	B	C	D	E	F	G
<b>H34VON</b>	31 <sup>1</sup> / <sub>4</sub> "	33 <sup>7</sup> / <sub>8</sub> "	29"	19 <sup>3</sup> / <sub>8</sub> "	1 <sup>1</sup> / <sub>8</sub> "	2 <sup>3</sup> / <sub>8</sub> "	23"
<b>H38VON</b>	35 <sup>1</sup> / <sub>4</sub> "	37 <sup>7</sup> / <sub>8</sub> "	33"	21 <sup>1</sup> / <sub>2</sub> "	1 <sup>1</sup> / <sub>4</sub> "	2 <sup>3</sup> / <sub>8</sub> "	25 <sup>3</sup> / <sub>4</sub> "
<b>H42VON</b>	39 <sup>1</sup> / <sub>2</sub> "	42"	37 <sup>1</sup> / <sub>4</sub> "	25 <sup>3</sup> / <sub>8</sub> "	1 <sup>1</sup> / <sub>4</sub> "	2 <sup>3</sup> / <sub>8</sub> "	28 <sup>7</sup> / <sub>8</sub> "

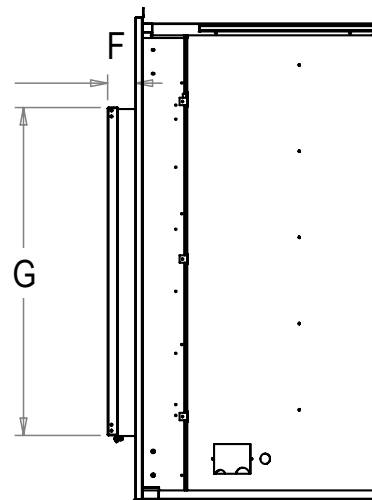
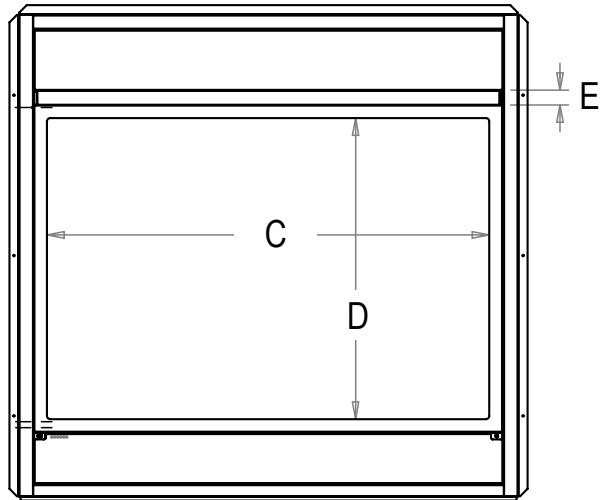
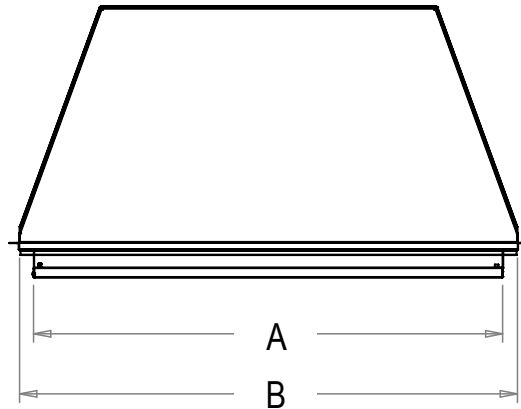

# Installation



Section:

## Tools Required

- Drill / Driver
- Phillips Screwdriver
- ¼" Hex driver
- ⅛" drill bit (Optional)

## Installing the Screen

**Step 1).** The RTSCH\*\*VO Screen Installation Kit contains two mounting brackets. One for each side of the Screen Assembly.

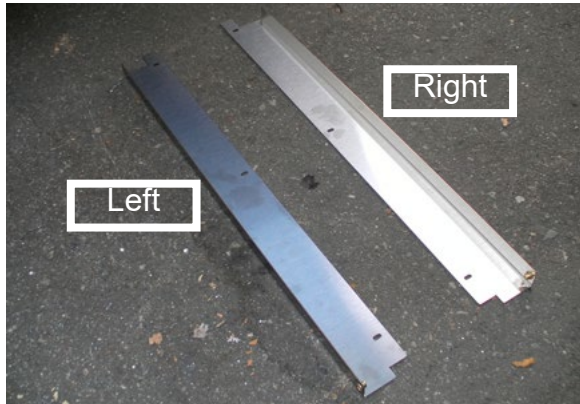

Figure 1.

**Step 2).** The lower portion of the mounting brackets can be identified by the small cutout and brass nutsert. The top contains a tab which is used for aligning the bracket.

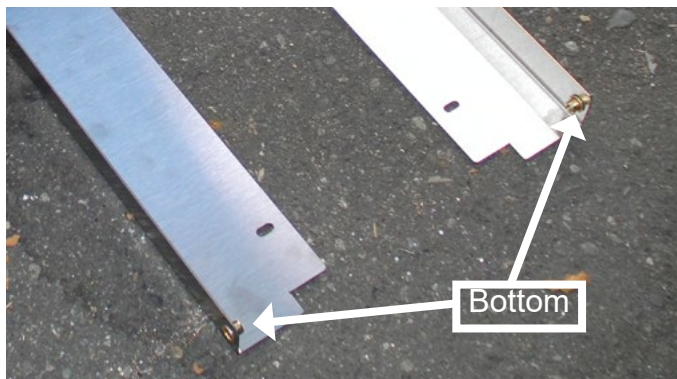

Figure 2.

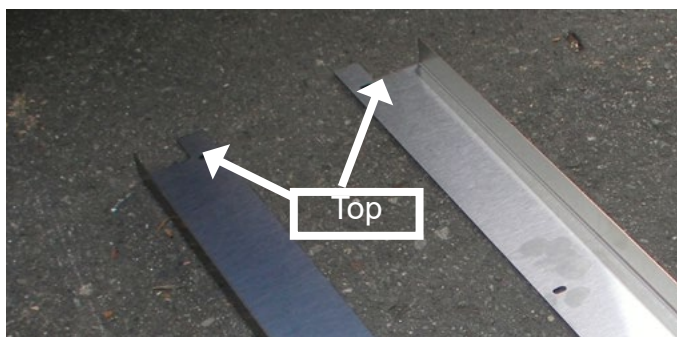

Figure 3.

**Step 3).** Align the cutout on the bottom of the left bracket with the lower, left corner of the fireplace.



Figure 4.



Figure 5.

**Step 4).** Align the tab on the top of the left bracket so that it is flush with the outer edge of the fireplace.



Figure 6.



# Installation

## Section:

**Step 5).** Insert three self drilling screws on the left side using the predrilled holes in the mounting brackets as a guide. Repeat for the right side. It is possible to predrill the holes using a 1/8" drill bit if preferred.



Figure 7.

**Step 7).** Secure the bottom of the screen using two stainless steel machine screws provided.



Figure 10.



Figure 8.



Figure 11.

**Step 6).** Hang the Screen Assembly on the top of the brackets.



Figure 9.

**Step 8).** Reverse steps 6 and 7 to remove screen.



# Installation



Section:

## Removing the door with the screen kit installed:

**Step 1).** Remove the screen (see Section 1: Screen Installation)

**Step 2).** Detach the lower portion of the door using door latches and tilt outwards (See Fireplace Installation & Maintenance Manual for further information).

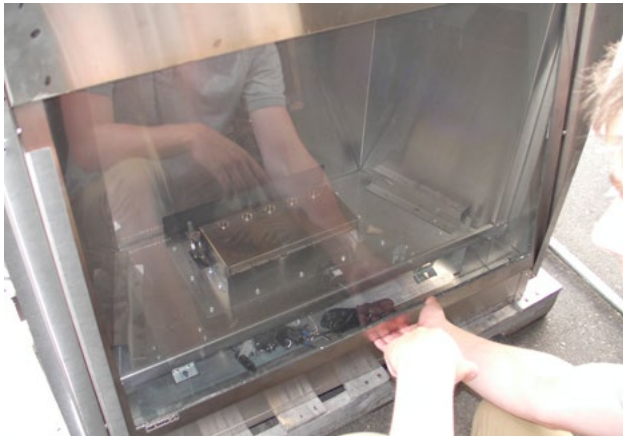

Figure 12.

**Step 3).** Pull the top of the door away from the fire box. Slide the door up to clear the screen mounting brackets.



Figure 13.

### WARNING

When installing the fireplace - gas lines, fittings, accessories or any other objects cannot impede the proper movement of the door buckles.



Figure 14.

### WARNING

When reinstalling door(s), always make sure all door buckles are properly hooked and fully engaged.

### CAUTION

Ensure that all power to the appliance is off at the electrical breaker or fuse before beginning installation. Ensure gas is turned off at the shutoff valve before beginning installation.

### DANGER

The exhaust discharge from the front top of the appliance and all material contacted by the exhaust are very hot and should not be touched.

The Screen Barrier will reduce the risk of burns from contact with the glass.

### CAUTION

Young children should be carefully supervised when they are in the same room as the appliance. Toddlers, young children and others may be susceptible to accidental contact burns. A physical barrier is recommended if there are at risk individuals in the house. To restrict access to a fireplace or stove, install an adjustable safety gate to keep toddlers, young children and other at risk individuals out of the room and away from hot surfaces.



# Operation



## Section 9: Start-up Sequence with Continuous Pilot

### For Your Safety - READ BEFORE LIGHTING:

## DANGER

**HOT GLASS WILL CAUSE BURNS.  
DO NOT TOUCH GLASS UNTIL COOLED.  
NEVER ALLOW CHILDREN TO TOUCH GLASS.**

A barrier designed to reduce the risk of burns from the hot viewing glass is provided with this appliance and must be installed for the protection of children and other at-risk individuals.

## WARNING

If the information in these instructions is not followed exactly, a fire or explosion may result causing property damage, personal injury or death.

**WARNING/ CAUTION:** Hot while in operation. Do not touch. Severe burns may result. Keep children, clothing, furniture, gasoline and other liquids having flammable vapours away. See installation and operating instructions accompanying this appliance.

- A. This appliance has a pilot which must be lit by hand. When lighting the pilot, follow these instructions exactly.
- B. BEFORE LIGHTING smell all around the appliance area for gas. Be sure to smell next to the floor because some gas is heavier than air and will settle on the floor.
  - What To Do If You Smell Gas:
    - Do not try to light any appliance.
    - Do not touch any electrical switch; do not use any phone in your building.
    - Immediately call your gas supplier from a neighbour's phone. Follow the gas supplier's instructions.
    - If you cannot reach your gas supplier, call the Fire Department.
- C. Use only your hand to push in or turn the gas control knob. Never use tools. If the knob will not push in or turn by hand, don't try to repair it. Call a qualified service technician. Force or attempt to repair may result in a fire or explosion.
- D. Do not use this appliance if any part has been under water. Immediately call a qualified service technician to inspect the appliance and to replace any part of the control system, and any gas control which has been under water.

### Lighting Instructions:

1. STOP! Read the safety information above on this label.
2. Locate the gas control behind the lower trim, or on the rear left side (on Cast stoves).
3. Push in gas control knob and turn clockwise to "OFF."
4. Wait five (5) minutes to clear out any gas. Smell for gas, including near the floor. If you smell gas, STOP! Follow "B" in the safety information above on this label. If you don't smell gas, go to the next step.
5. Locate pilot burner (See illustrations and follow steps below.
6. Turn knob on gas control counter clockwise to "PILOT."
7. Push in gas control knob completely and hold. Light with Piezo Igniter button. Continue to hold the control knob in for about (1) minute after the pilot is lit. Release the knob and it will pop back up. Pilot should remain lit. If it goes out repeat steps 3 through 7.
  - If knob does not pop up when released, STOP! Immediately call your service technician or gas supplier.
  - If the pilot will not stay lit after several tries, turn the gas control knob to "OFF" and call your service technician or gas supplier.
8. Push in gas control knob and turn counter clockwise to "ON."
9. Turn on remote switch to ignite fire.

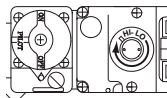

Robert Shaw Valve

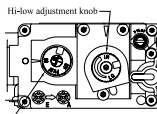

SIT 820 HI/LO Valve

NOTE: Knob cannot be turned from "PILOT" to "OFF" unless knob is pushed in slightly. Do not force.

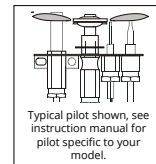

### To Turn Off Gas To Appliance:

1. Turn fireplace off using wall switch or remote control.
2. Locate the gas control behind the lower trim, or on the rear left side (on Cast stoves).
3. Push in gas control knob slightly and turn clockwise to "Off". Do not force.
4. Turn incoming gas control valve to off

11169-11/2017

# Operation



## Section 9: Start-up Sequence with Honeywell Ignition

### FOR YOUR SAFETY - READ BEFORE LIGHTING:

## DANGER

**HOT GLASS WILL CAUSE BURNS. DO NOT TOUCH GLASS UNTIL COOLED.**

**NEVER ALLOW CHILDREN TO TOUCH GLASS.**

A barrier designed to reduce the risk of burns from the hot viewing glass is provided with this appliance and must be installed for the protection of children and other at-risk individuals.

**WARNING** If the information in these instructions are not followed exactly, a fire or explosion may result causing property damage, personal injury or death.

**WARNING / CAUTION:** Hot while in operation. Do not touch. Severe burns may result. Keep children, clothing, furniture, gasoline and other liquids having flammable vapors away.

See installation and operating instructions accompanying this appliance.

- |  |  |
|--|--|
| <p>A. This appliance has a pilot which is lit automatically. Do not attempt to light the pilot by hand.</p> <p>B. BEFORE LIGHTING smell all around the appliance area for gas. Be sure to smell next to the floor because some gas is heavier than air and will settle on the floor.</p> <p>What To Do If You Smell Gas:</p> <ul style="list-style-type: none"> <li>■ Do not try to light the appliance.</li> <li>■ Do not touch any electrical switch. Do not use any phone in your building.</li> <li>■ Immediately call your gas supplier from a neighbour's phone. Follow the gas suppliers instructions.</li> </ul> | <ul style="list-style-type: none"> <li>■ If you cannot reach your gas supplier, call the Fire Department.</li> </ul> <p>C. Use only your hand to push in or turn the gas control knob. Never use tools. If the knob will not push in or turn by hand, don't try to repair it. Call a qualified service technician. Force or attempt to repair may result in a fire or explosion.</p> <p>D. Do not use this appliance if any part has been under water. Immediately call a qualified service technician to inspect the appliance and to replace any part of the control system, and any gas control which has been under water.</p> |
|--|--|

### LIGHTING INSTRUCTIONS:

- |   |   |
|---|---|
| <ol style="list-style-type: none"> <li>1. STOP! Read the safety information above on this label.</li> <li>2. Turn the fireplace "OFF" using the wall switch or remote control.</li> <li>3. Wait 5 minutes to clear out any gas. If you smell gas, STOP! Follow "B" in the safety information above on this label. If you don't smell gas, go to the next step.</li> <li>4. Turn the fireplace "ON" using the wall switch or remote control.</li> </ol> <p><b>NOTE:</b> This unit is equipped with an ignition system that lights the pilot burner automatically. Do not attempt to light the pilot by hand.</p> <p>This unit is equipped with advanced safety controls including pre and post purge timers. The fireplace will not turn on until all of the safety conditions are met. The fans in the fireplace may operate for an extended period of time even after the wall switch is turned off.</p> | <ol style="list-style-type: none"> <li>5. The wall switch LED and heat sensor LED will light up.</li> <li>6. Once the predetermined airflow is established in the firebox, the flue gas switch LED will light up after 30 seconds.</li> <li>7. After approximately 1 minute the hot surface igniter will start to glow. The pilot will light up, followed by the main burner. The fireplace will then start up.</li> </ol> <p><b>NOTE:</b> If the igniter does not glow, even after 3 minutes have passed, follow the instructions "To Turn Off Gas To Appliance" and call your service technician or Montigo dealer.</p> |
|---|---|

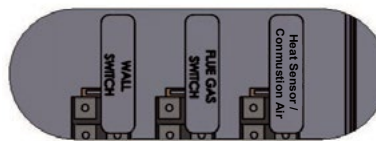

Control box LED lights

### TO TURN OFF GAS TO APPLIANCE:

- |  |  |
|--|--|
| <ol style="list-style-type: none"> <li>1. Turn the fireplace off using the wall switch or remote control.</li> <li>2. Turn off all electrical power to the appliance.</li> </ol> | <ol style="list-style-type: none"> <li>3. Locate the gas shut off valve for the appliance and turn off.</li> </ol> |
|--|--|

PIN LB1170-050514



# Maintenance

## Lighting Instructions

See pages 14 to 16.

## General

- **Have the fireplace and installation inspected yearly.** The inspection must include, but is not limited to, the following:
  - • A visual check of the entire vent system and termination.
  - • An inspection of the explosion relief flappers and the door gaskets to ensure a proper seal.
  - • An inspection of the burner, vent run, and primary air openings.
  - • An inspection of the gas valve, gas components, and pilot flame. For your convenience a 1/8" manifold pressure tap is supplied on the gas valve for a test gauge connection.
  - • Ensure proper log placement as per this manual.
  - • Inspection of all optional equipment; fans, thermostats, etc.
- For **Natural Gas** this appliance requires a minimum inlet pressure of 5.5" W.C. and a manifold pressure of 3.5" W.C.
- For **Propane Gas** this appliance requires a minimum inlet pressure of 11" W.C. and a manifold pressure of 10" W.C.
- Always keep the fireplace area clear and free of combustible materials, as well as gasoline and other flammable vapours and liquids.
- Do not use this appliance if *any part has been under water*. Immediately call a qualified service technician to inspect the appliance and to replace any part of the control system and any gas control which has been under water.

## Cleaning

When the fireplace is first activated, there may be some smoking and a visible film may be left on the glass. This is a normal condition, and is the result of burning of protective coatings on new metal.

- Glass must be cleaned periodically to remove any film (which is a normal by-product of combustion) which may be visible. Film can easily be removed by removing the door, as shown on **Page 10**. Handle the door carefully, and clean it with non-abrasive glass cleaners. One of the most effective products is Kel Kem.
- Silicone seals on inner door during initial firing will "off gas", leaving a visual deposit of a white substance on combustion chamber walls. This can easily be removed using normal household products.
- Use a vacuum cleaner or whisk broom to keep the control compartment, burner, and firebox free from dust and lint.
- Logs may be cleaned periodically with a vacuum to remove soot or other contaminants.



### CAUTION!

- Fireplace gas control must be in the "OFF" position and pilot and main burners extinguished when cleaning appliance with a vacuum.
- Doors can get very hot. Handle only when cool.

## Burner Adjustment

The **H-Series VO** is equipped with an adjustable burner, allowing you to raise or lower the flames. To adjust the flames, locate the black knob marked 'Hi-Lo', in the centre of the gas control valve (See Figure 11). The front burners are not adjustable.

- To raise the flame height, turn the black knob (located behind the lower trim) **counterclockwise**.
- To lower the flame height, turn **clockwise**.

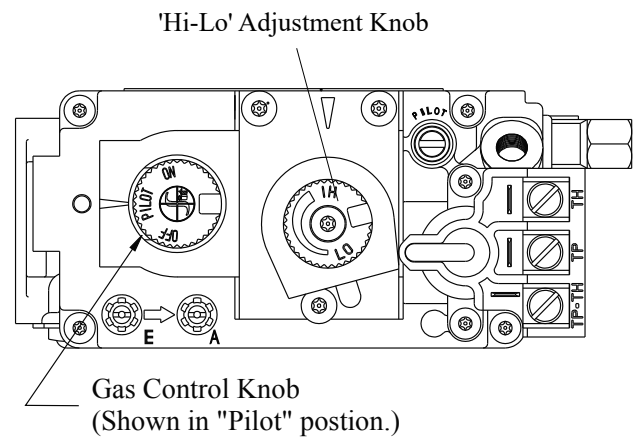

Figure 12. 'Hi-Lo' Adjustment on the H-Series VO's gas valve.



## Replacement Parts

	<b>H34VON</b>	<b>H38VON</b>	<b>H42VON</b>
<b>NG Gas Valve</b>	RGC1006	RGC1006	RGC1006
<b>LP Gas Valve</b>	RGC1005	RGC1005	RGC1005
<b>NG Pilot</b>	RPA020	RPA020	RPA020
<b>LP Pilot</b>	RPA021	RPA021	RPA021
<b>Burner NG</b>	RBH3401	RBH3801	RBH4201
<b>Burner LPG</b>	RBH3402	RBH3802	RBH4202
<b>Orifice NG</b>	ROR1135	ROR1137	ROR1139
<b>Orifice LPG</b>	ROR1136	ROR1138	ROR1140
<b>Door</b>	RDTH34SS	RDTH38SS	RDTH42SS
<b>Log Set</b>	RLGSH34	RLGSH38	RLGSH42
<b>Log Base</b>	RLGSH34B	RLGSH38B	RLGSH42B

# Appendix

## Appendix B: Warranty

### MONTIGO RESIDENTIAL WARRANTY PROGRAM

Canadian Heating Products Inc. and/or Montigo DelRay Corp (collectively referred to herein as "The Companies"), warrants the Montigo gas appliance (referred to herein as 'the appliance') to be free from defects in materials and workmanship at the time of manufacture. The gas appliance and related components are further subject to the terms and conditions set forth below.

This warranty covers the following Montigo product series: **Distinction, Divine & Divine Outdoor (H-Series), Illume (FID Inserts), Phenom (L/P/PL-Series), Exemplar (R/RP-Series), Mahana and DelRay**

Component	Coverage Period	Labor Coverage
Firebox, heat exchanger	15 years	1 year
Main burner	15 years	1 year
Gas control valve and related control components (pilot assembly, spark electrode flame sensors, thermopile)	1 year	1 year
Electrical components (internal blowers, ignition control module, wiring, switches, remote control systems, blower control module, accent bulbs)	1 year	1 year
Firebox media (logset, glass beads, river rocks)	1 year	1 year
Glass (thermal breakage)	1 year	1 year
Plated, painted finishes (including interior reflective glass) *	1 year	1 year
Refractory lining	1 year	1 year
Mesh/Glass safety barriers	1 year	1 year
Power vent termination	1 year	1 year
Montigo terminations*	10 years	1 year
Montigo venting (excluding termination)	15 years	1 year

\* Exterior painted surfaces exempt

### QUALIFICATIONS TO THE WARRANTY

This Warranty only covers gas appliances installed in the United States or Canada.

To receive the benefits of this warranty, the appliance must be purchased, installed and serviced annually by a dealer authorized by The Companies for the warranty to be valid.

The gas appliance must be installed by a licensed professional in accordance with The Companies' installation instructions and local building codes. The warranty on the appliance covers only components manufactured by The Companies. The use of components manufactured or supplied by other manufacturers and used in conjunction with the appliance could create serious safety hazards, may result in the denial of certification by recognized national safety agencies and could violate local building codes. Such use may untimely void this warranty. This warranty does not cover any damages occurring from the use of any components not manufactured or supplied by The Companies.

The appliance must be subjected to normal use. The appliance is designed to burn natural gas (NG) or liquefied petroleum (LP) only. Burning conventional fireplace fuels such as wood, coal or any other solid fuel will cause damage to the appliance, produce

excessive temperatures will result in a fire hazard and void all warranties. This warranty is transferable. The appliance must remain in its original place of installation to be valid.

If the components of the appliance covered by this warranty are found to be defective within the time frame stated (see The Companies investigation of claims), The Companies will, at its option, replace or repair defective components of the appliance manufactured by The Companies at no charge and will also pay for labor costs (in accordance with schedule) incurred in replacing or repairing components. If repair or replacement is not commercially practical, The Companies will, at its sole discretion, fully discharge all obligations under the warranty by refunding the verified dealer purchase price of the appliance, excluding the cost of labor unless the labor is covered by the terms of the warranty.

This warranty covers only parts and labor as provided above. In no case shall the companies be responsible for materials, components or construction, which are not manufactured or supplied by The Companies, or for the labor necessary to install, repair or remove such materials, components or construction. All replacement or repair components will be shipped F.O.B. from the nearest Company factory.

### LIMITATION ON LIABILITY

It is agreed and understood that The Companies sole obligation, and purchaser's exclusive remedy under this warranty, under any other warranty, expressed or implied, or in contract, tort or otherwise, shall be limited to repair, replacement or refund as specified above. The opinion of The Companies with respect to these matters shall be final.

In no event shall The Companies be responsible for any incidental or consequential damages caused by (but not limited to) improper installation, installation by an unqualified or unauthorized installer, accident, lack of regular maintenance, user error, abuse, misuse, Acts of God, power surges, floods, natural disasters, force majeure, defects in its appliance whether such damage occurs or is discovered before or after replacement or repair, and whether or not such damage is caused by The Companies negligence. Some jurisdictions do not allow the exclusion or limitation of incidental or consequential damages, so the above limitation or exclusion may not apply to you. The duration of any implied warranty with respect to the appliance is limited to the duration of the foregoing warranty. Some jurisdictions do not allow limitations on how long an implied warranty lasts, so the above limitation or exclusion may not apply to you.

# Appendix

## Appendix B: Warranty Continued

### EXCLUSIONS TO WARRANTY

Corrosion or rust of any kind due to a lack of maintenance, inadequate combustion air or improper venting and corrosive chemicals/environments, expansion and contraction of metals or minor movements of components causing noise are not covered by this warranty.

Willful misconduct (i.e. use of the appliance with problems known to the purchaser and causing further damages), including unauthorized or self-performed 'fixing' or exploration of the appliance's internal workings will void the warranty.

Appliances on which the serial number has been altered, defaced, removed or made illegible will void the warranty.

Costs incurred for diagnosis, service work, shipping and handling of defective or replacement parts are not covered under this warranty.

The published warranties are not applicable for any equipment manufactured by The Companies that has been sold direct to the consumer via internet or auction websites. The Companies do not endorse, approve or certify any online sale of its products through auction websites, online retailers or any other method of online sales direct to consumers.

### INVESTIGATION OF CLAIMS AGAINST WARRANTY

The Companies reserve the right to investigate any and all claims against this warranty and decide upon method of settlement.

The Companies are not responsible for work done without written consent of The Companies.

The Companies shall in no event be responsible for any warranty work done without first obtaining the Companies written consent.

The Companies employees and dealers have no authority to make any warranties to neither alter this warranty nor authorize any remedies in addition to or inconsistent with those stated within this warranty.

### IF WARRANTY SERVICE IS NEEDED

To make a claim under this warranty, contact your installing dealer or contractor. The installing dealer is responsible for providing service and will contact the companies to initiate warranted parts replacements. In the event the installing dealer is unavailable, contact your nearest authorized Montigo dealer ([www.Montigo.com](http://www.Montigo.com)) or contact Montigo direct at [techsupport@montigo.com](mailto:techsupport@montigo.com). Ensure you have your sales receipt and the model and serial number of your appliance.

### DO NOT ATTEMPT TO DO ANY SERVICE WORK YOURSELF

If you cannot locate the installing dealer, or nearest dealer/distributor, you must notify The Companies in writing.

### USA Offices

6955 Salashan Parkway  
Ferndale WA, 98248  
[techsupport@montigo.com](mailto:techsupport@montigo.com)

### Canadian Offices

27342 Gloucester Way  
Langley, BC V4W 4A1  
[techsupport@montigo.com](mailto:techsupport@montigo.com)

The terms and conditions of this warranty may be altered or amended from time to time without prior notice.

**WARRANTY PERIOD:** Warranty coverage begins on the date of original purchase. In the case of new construction, warranty coverage begins on the date of first occupancy of the dwelling or six months after the sale of the product by an independent, authorized Company dealer/ distributor, whichever occurs earlier.



Section:

# Maintenance

## Appendix C: Amendment

### (Gas Fireplace / Equipment sold in the State of Massachusetts) 5.08: Modifications to NFPA-54, Chapter 10

- (1) Revise NFPA-54 section 10.5.4.2 by adding a second exception as follows:

Existing chimneys shall be permitted to have their use continued when a gas conversion burner is installed, and shall be equipped with a manually reset device that will automatically shut off the gas to the burner in the event of a sustained back-draft.

- (2) Revise 10.8.3 by adding the following additional requirements:

- (a) For all side wall horizontally vented gas fueled equipment installed in every dwelling, building or structure used in whole or in part for residential purposes, including those owned or operated by the Commonwealth and where the side wall exhaust vent termination is less than seven (7) feet above finished grade in the area of the venting, including but not limited to decks and porches, the following requirements shall be satisfied:

1. **INSTALLATION OF CARBON MONOXIDE DETECTORS.** At the time of installation of the side wall horizontal vented gas fueled equipment, the installing plumber or gas fitter shall observe that a hard wired carbon monoxide detector with an alarm and battery back-up is installed on the floor level where the gas equipment is to be installed. In addition, the installing plumber or gas fitter shall observe that a battery operated or hard wired carbon monoxide detector with an alarm is installed on each additional level of the dwelling, building or structure served by the side wall horizontal vented gas fueled equipment. It shall be the responsibility of the property owner to secure the services of qualified licensed professionals for the installation of hard wired carbon monoxide detectors
  - a. In the event that the side wall horizontally vented gas fueled equipment is installed in a crawl space or an attic, the hard wired carbon monoxide detector with alarm and battery back-up may be installed on the next adjacent floor level.
  - b. In the event that the requirements of this subdivision can not be met at the time of completion of installation, the owner shall have a period of thirty (30) days to comply with the above requirements; provided, however, that during said thirty (30) day period, a battery operated carbon monoxide detector with an alarm shall be installed.
2. **APPROVED CARBON MONOXIDE DETECTORS.** Each carbon monoxide detector as required in accordance with the above provisions shall comply with NFPA 720 and be ANSI/UL 2042 listed and IAS certified.
3. **SIGNAGE.** A metal or plastic identification plate shall be permanently mounted to the exterior of the building at a minimum height of eight (8) feet above grade directly in line with the exhaust vent terminal for the horizontally vented gas fueled heating appliance or equipment. The sign shall read, in print size no less than one-half (1/2) inch in size, "GAS VENT DIRECTLY BELOW. KEEP CLEAR OF ALL OBSTRUCTIONS".

4. **INSPECTION.** The state or local gas inspector of the side wall horizontally vented gas fueled equipment shall not approve the installation unless, upon inspection, the inspector observes carbon monoxide detectors and signage installed in accordance with the provisions of 248 CMR 5.08(2)(a)1 through 4.

- (b) **EXEMPTIONS:** The following equipment is exempt from 248 CMR 5.08(2)(a)1 through 4:

1. The equipment listed in Chapter 10 entitled "Equipment Not Required To Be Vented" in the most current edition of NFPA 54 as adopted by the Board; and
2. Product Approved side wall horizontally vented gas fueled equipment installed in a room or structure separate from the dwelling, building or structure used in whole or in part for residential purposes.
  - (c) **MANUFACTURER REQUIREMENTS - GAS EQUIPMENT VENTING SYSTEM PROVIDED.** When the manufacturer of Product Approved side wall horizontally vented gas equipment provides a venting system design or venting system components with the equipment, the instructions provided by the manufacturer for installation of the equipment and the venting system shall include:
    1. Detailed instructions for the installation of the venting system design or the venting system components; and
    2. A complete parts list for the venting system design or venting system.
  - (d) **MANUFACTURER REQUIREMENTS - GAS EQUIPMENT VENTING SYSTEM NOT PROVIDED.** When the manufacturer of a Product Approved side wall horizontally vented gas fueled equipment does not provide the parts for venting the flue gases, but identifies "special venting systems", the following requirements shall be satisfied by the manufacturer:
    1. The referenced "special venting system" instructions shall be included with the appliance or equipment installation instructions; and
    2. The "special venting systems" shall be Product Approved by the Board, and the instructions for that system shall include a parts list and detailed installation instructions.
  - (e) A copy of all installation instructions for all Product Approved side wall horizontally vented gas fueled equipment, all venting instructions, all parts lists for venting instructions, and/or all venting design instructions shall remain with the appliance or equipment at the completion of the installation.

- (3) After NFPA-54 section 10.10.4.2 add a new section 10.10.4.3 as follows:

When more than four gas appliances are to be vented through a common gas vent or common horizontal vent manifold, a plan of the proposed vent installation shall be submitted to the Inspector and the serving gas supplier for review and approval.

Extraction from: Massachusetts Rules and Regulations

5.00: Amendments To 2002 Edition Of ANSI Z223.1-NFPA-54



**Notes**

Two columns of horizontal lines for taking notes.

# **Divine Outdoor VO Outdoor Gas Fireplace**