

CORNER FASTENER (W/ LOCK) STF-C64A/STF-C64B With/Without Spring

LOAD CAPACITY **330 N** SUS



- Designed to allow front operation.
- Can be used with corner fastener hinge STH-C64 **1**.
- With safety lock to prevent accidental release.
- Can be used with padlock **2**.
- Available with or without spring.
- Strike hooks are also sold separately.

[Applications]

- Doors and covers required for dust proof, drip proof and vibration prevention, measuring equipment, communication equipment, machine tools, etc.

[Remarks]

- The clamping margin of STF-C64A shall not exceed 4mm.

[Parts Included]

- Strike hook

[Sold Separately]

- Sealing pin 502-7SS, 502-9SS, 613-9SS
- Strike hook 01-613SS, 02-613SS, 07-613SS



Corner fastener hinge **1** also available.

[Installation]

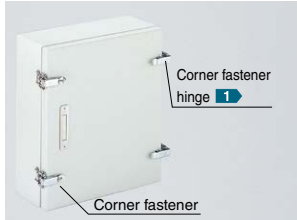

When locked



Pull lever and lift latch to open.



When opened

[When Locked]

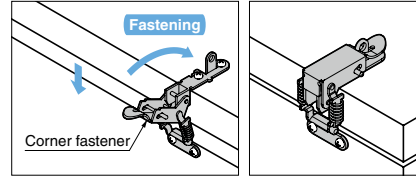

[STF-C64A Clamping Force]

Clamping Margin mm	Clamping Force N	Clamping Force kgf
1	15	1.5
2	30	3.1
3	45	4.6
4	60	6.1

Clamping force is only a guide.

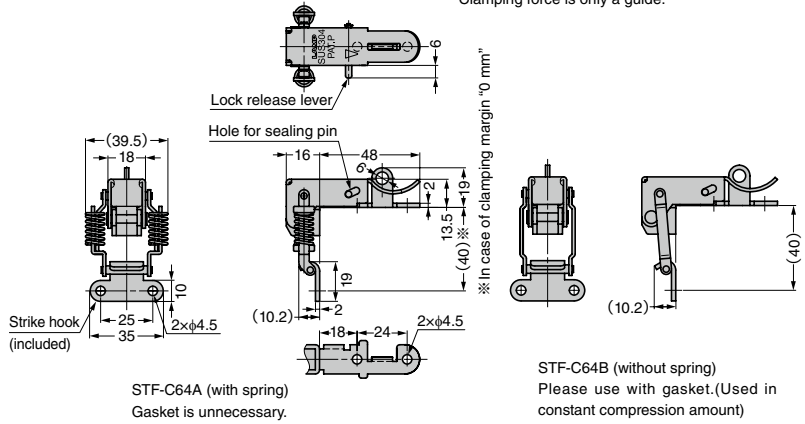

[Body]

RhS	CAD	Item Code	Item Name	Type	Door Thickness	Load Capacity N	Load Capacity kgf	Material	Finish	Weight (g)	Box (pcs)	Carton (pcs)
		120-042-200	STF-C64A	With Spring	14~28	330	34	Stainless Steel (SUS304)	Barrel	66.5	15	210
		120-042-201	STF-C64B	Without Spring					Polished	60	15	210

[Sealing Pin] Sold Separately

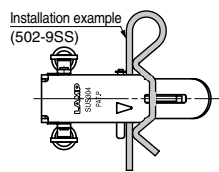

Material	Finish
Stainless Steel (SUS304)	Plain

Used for preventing malfunction of lock release lever.

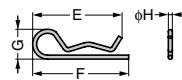

RhS	CAD	Item Code	Item Name	E	F	G	H	Weight (g)	Box (pcs)	Carton (pcs)
		120-041-823	502-9SS	63	66	18	2.6	-	1	-
		120-041-825	613-9SS	55	59	15	2.3	4	1	-

RhS	CAD	Item Code	Item Name	Weight (g)	Box (pcs)	Carton (pcs)
		120-041-822	502-7SS	3	1	-

Refer to **1** : P.284, **2** : P.873

[Strike Hook] Sold Separately

Material	Finish
Stainless Steel (SUS304)	Barrel Polished

RhS	CAD	Item Code	Item Name	Weight (g)	Box (pcs)	Carton (pcs)
		120-040-415	01-613SS	5	1	-

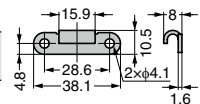

RhS	CAD	Item Code	Item Name	Weight (g)	Box (pcs)	Carton (pcs)
		120-040-421	02-613SS	7	1	-

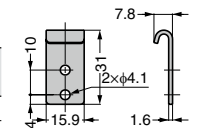

RhS	CAD	Item Code	Item Name	Weight (g)	Box (pcs)	Carton (pcs)
		120-040-452	07-613SS	10	1	-

