

IntAfit 76mm Locking Heavy Duty Runners

Profile Height: 76mm

Profile Width: 19.2mm

Load Rating: 227kg (based on 457mm)

Extension: Double

Perfect Solution For:

- Tool Storage
- Vehicle Conversions
- Industrial Machinery
- Computer Server Storage
- ATM & Vending Machines

Closed Length	SKU
304mm (12")	DS76012LK2
355mm (14")	DS76014LK2
406mm (16")	DS76016LK2
457mm (18")	DS76018LK2
508mm (20")	DS76020LK2
559mm (22")	DS76022LK2
610mm (24")	DS76024LK2
660mm (26")	DS76026LK2
711mm (28")	DS76028LK2
762mm (30")	DS76030LK2
813mm (32")	DS76032LK2
864mm (34")	DS76034LK2
914mm (36")	DS76036LK2
965mm (38")	DS76038LK2
1016mm (40")	DS76040LK2
1067mm (42")	DS76042LK2
1118mm (44")	DS76044LK2
1169mm (46")	DS76046LK2
1219mm (48")	DS76048LK2
1270mm (50")	DS76050LK2
1321mm (52")	DS76052LK2
1372mm (54")	DS76054LK2
1422mm (56")	DS76056LK2
1473mm (58")	DS76058LK2
1524mm (60")	DS76060LK2

Load rating testing shown is for a 30,000 cycle test for extendible elements deeper than wide. Drawer runners which are installed in drawers that are wider than they are deep are subject to lateral stress which will reduce load carrying capacity. Test was done according to ANSI/BIFMA X5.9 - 2008 Standard 15.2.1. Please contact us if you have any questions regarding product specification & testing results.

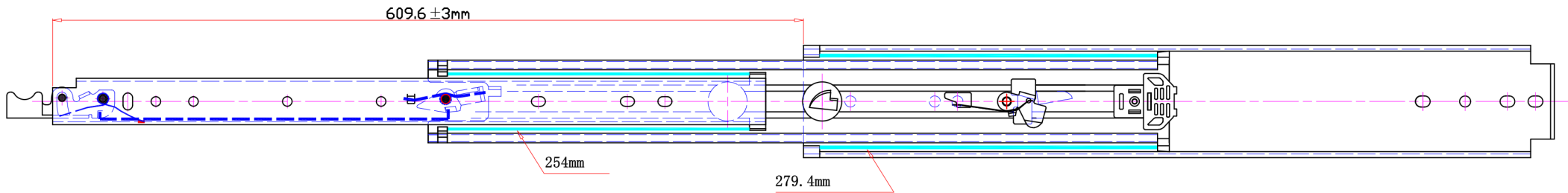
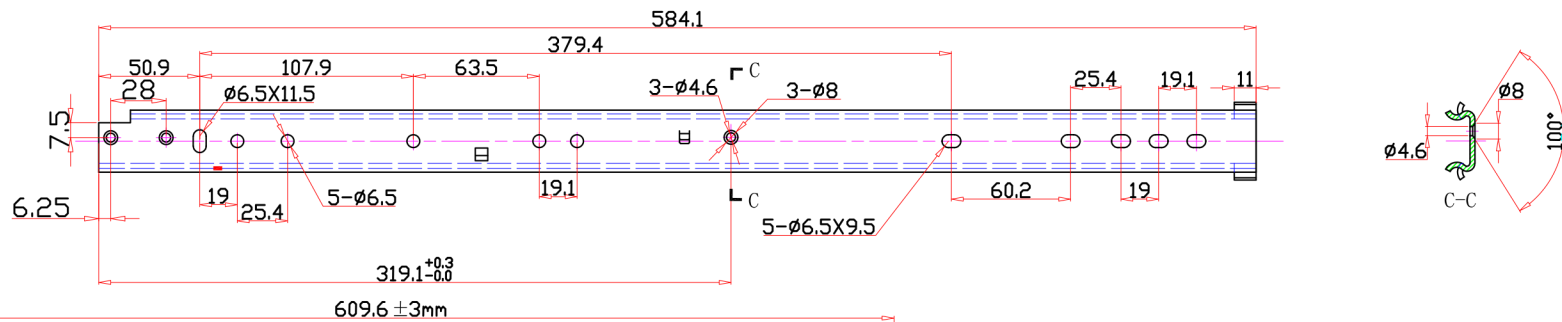
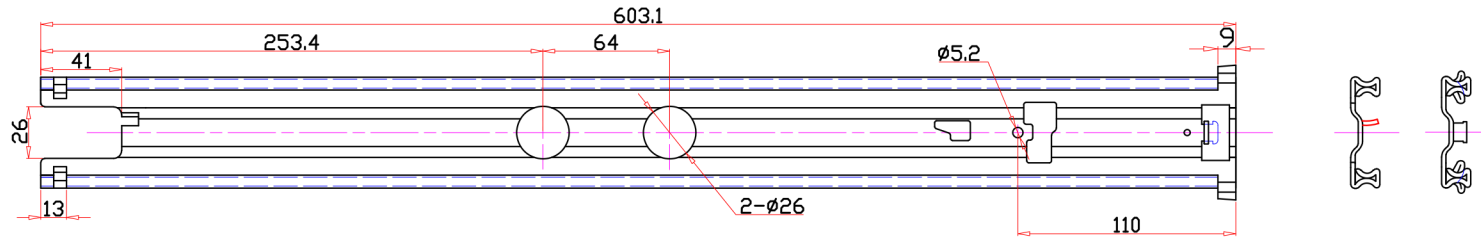
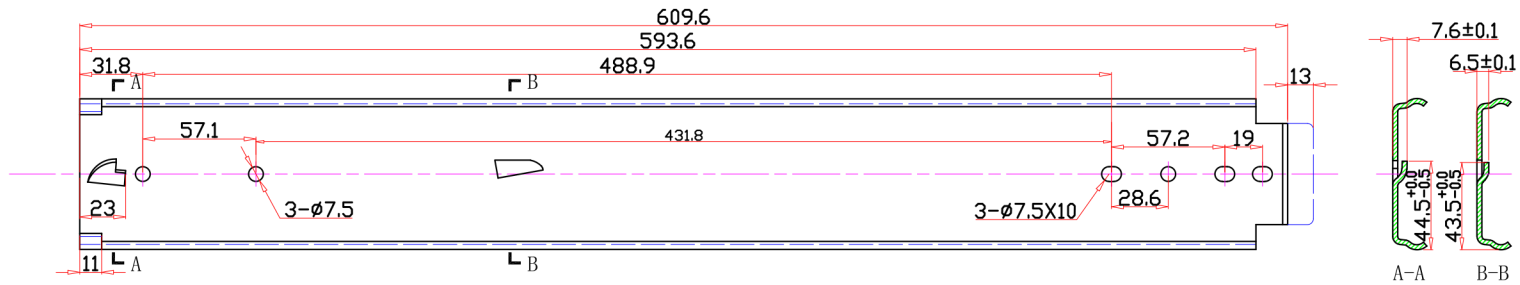

DS76024LK2