

IntAfit 76mm Heavy Duty Runners

Profile Height: 76mm

Profile Width: 19.2mm

Load Rating: 227kg (based on 457mm)

Extension: Double

Perfect Solution For:

- Tool Storage
- Vehicle Conversions
- Industrial Machinery
- Computer Server Storage
- ATM & Vending Machines

Closed Length	SKU
304mm (12")	DS76012
355mm (14")	DS76014
406mm (16")	DS76016
457mm (18")	DS76018
508mm (20")	DS76020
559mm (22")	DS76022
610mm (24")	DS76024
660mm (26")	DS76026
711mm (28")	DS76028
762mm (30")	DS76030
813mm (32")	DS76032
864mm (34")	DS76034
914mm (36")	DS76036
965mm (38")	DS76038
1016mm (40")	DS76040
1067mm (42")	DS76042
1118mm (44")	DS76044
1169mm (46")	DS76046
1219mm (48")	DS76048
1270mm (50")	DS76050
1321mm (52")	DS76052
1372mm (54")	DS76054
1422mm (56")	DS76056
1473mm (58")	DS76058
1524mm (60")	DS76060

Load rating testing shown is for a 30,000 cycle test for extendible elements deeper than wide. Drawer runners which are installed in drawers that are wider than they are deep are subject to lateral stress which will reduce load carrying capacity. Test was done according to ANSI/BIFMA X5.9 - 2008 Standard 15.2.1. Please contact us if you have any questions regarding product specification & testing results.

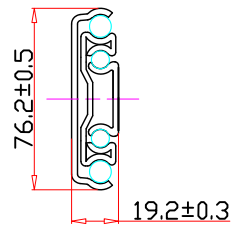
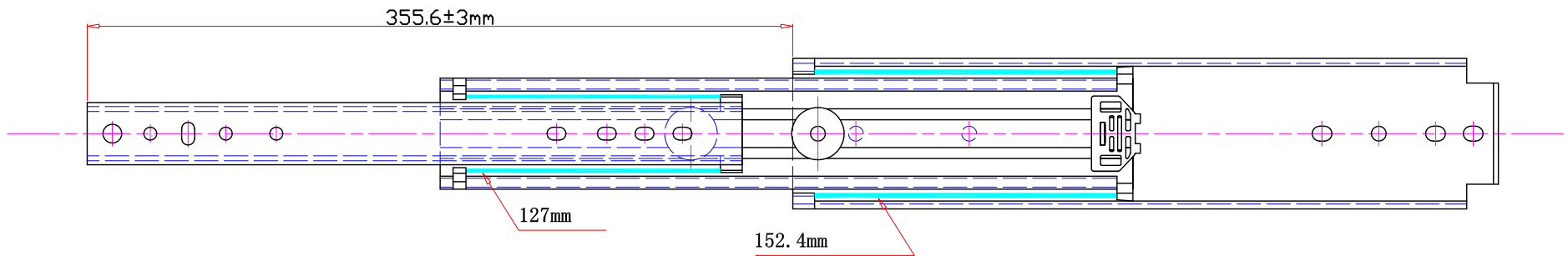
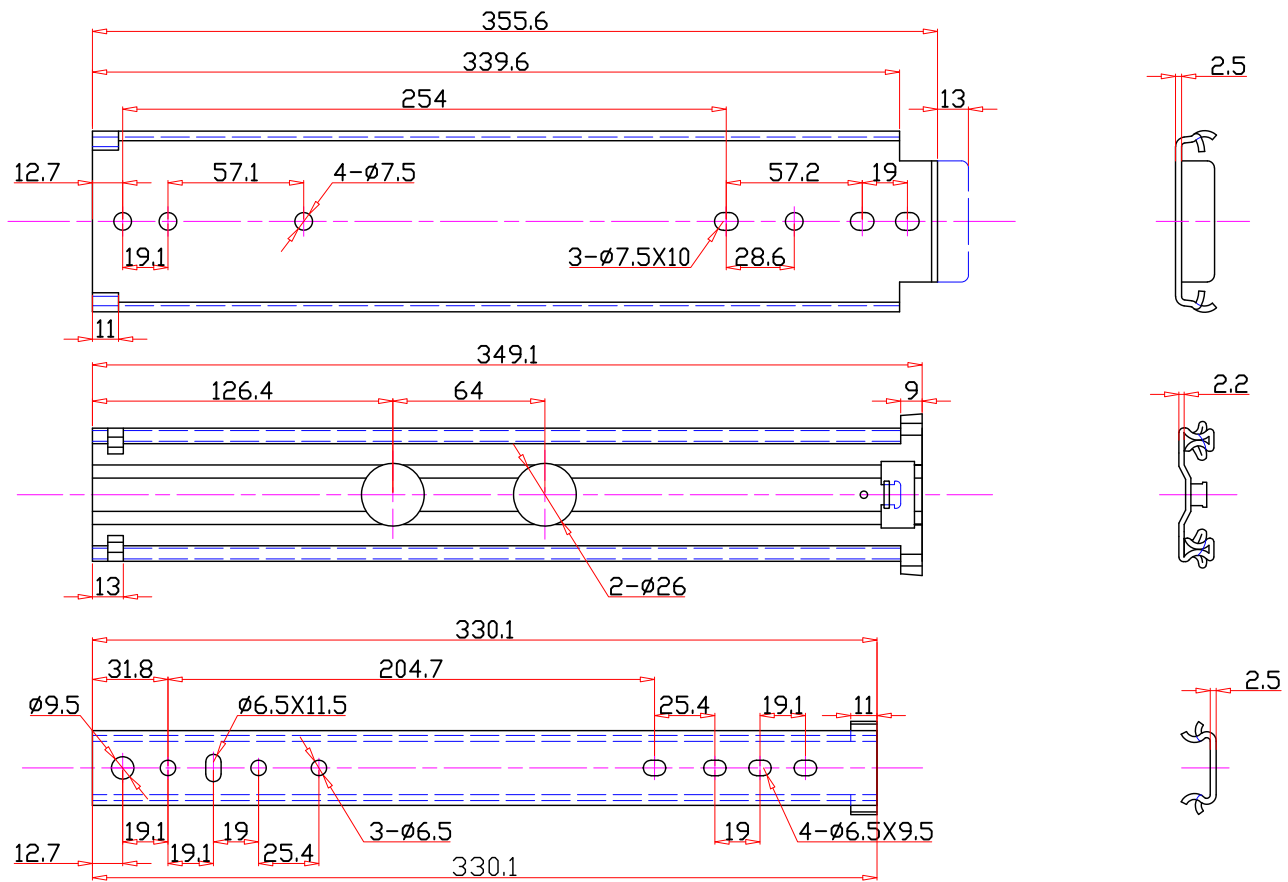

DS76014