



39mm Ball Bearing Table Slide

Load Rating: 50kg

Slide Profile Height: 39.5mm

Slide Profile Thickness: 13mm

Slide & Bracket Profile Height: 42.5mm

Slide & Bracket Profile Thickness: 34mm

Synchronised by Cable

Length

838mm

SKU

DS50838

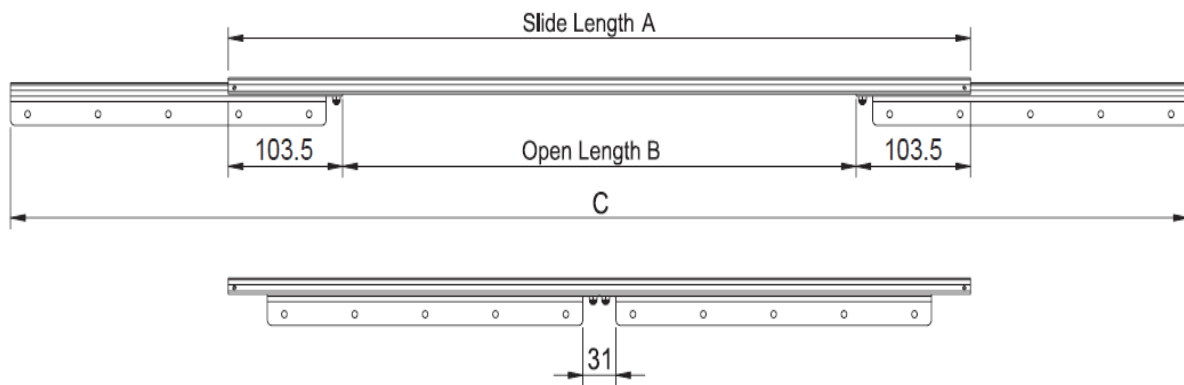

Outer Member

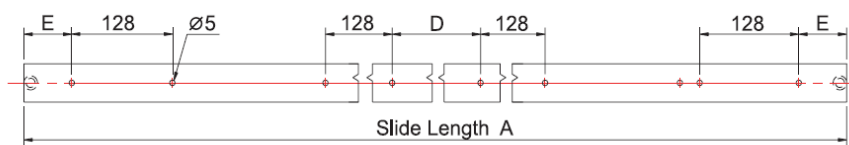

Profile

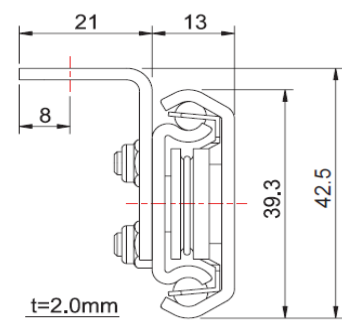

Wing

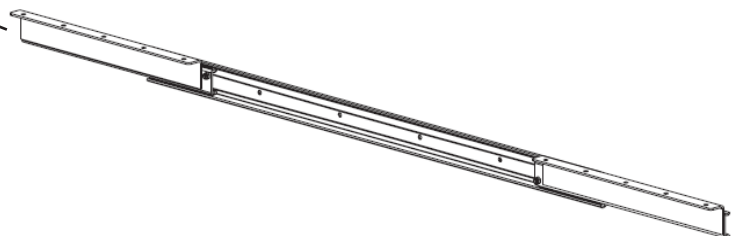
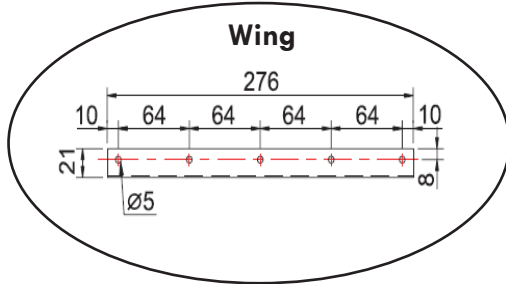

SKU	Slide Length A (mm)	Open Length B (mm)	C (mm)	D (mm)	E (mm)	Load Rating
DS50838	838	631	1214	241	42.5	50KG

Dimensions not binding.