



TRIDONIC

▼ enlightening your ideas



Catalogue 2012

Magnetic chokes for fluorescent lamps

Overview

| | |
|------------------|--------|
| Product overview | Page 4 |
| Standards | Page 5 |

Product information

| | |
|---------------------------------------|--------|
| Magnetic chokes for fluorescent lamps | Page 6 |
|---------------------------------------|--------|

EC series

Suitable for lamp type

230 V 50 Hz

| | | | | |
|-------------------------------------|---------|----|----|-----|
| EC 4 – 85 W, push-in terminal | Page 8 | T5 | T8 | CFL |
| EC 15 – 75 W, ConCut / IDC terminal | Page 10 | • | • | • |

240 V 50 Hz

| | | | | |
|-------------------------------------|---------|---|---|---|
| EC 4 – 26 W, push-in terminal | Page 12 | • | • | • |
| EC 15 – 75 W, ConCut / IDC terminal | Page 14 | • | • | • |

ETAWATT series

230 V 50 Hz

| | | | | |
|-------------------|---------|--|---|---|
| ETAWATT 18 – 58 W | Page 16 | | • | • |
|-------------------|---------|--|---|---|

EC series, protection class II

230 V 50 Hz

| | | | | |
|--------------|---------|--|---|---|
| EC 18 – 28 W | Page 17 | | • | • |
|--------------|---------|--|---|---|

| | |
|---|---------|
| Wiring diagrams and installation examples | Page 18 |
|---|---------|

Product overview

**EC**

Lamp types: T5, T8, T12, TC-L,
TC-S, TC-D, TC-DD

Magnetic chokes for linear and compact fluorescent lamps:

- Max. winding temperature $t_w = 130\text{ °C}$
- Nominal life time 100,000 hours at $t_w = 130\text{ °C}$
- Additional types on request

**ETAWATT**

Lamp types: T8, T12, TC-L,
TC-D, TC-DD

Magnetic chokes for linear and compact fluorescent lamps:

- Max. winding temperature $t_w = 130\text{ °C}$
- Plug terminal $0.5 - 1.5\text{ mm}^2$ for rigid wires

**EC (SK 2)**

Lamp types: T5, T8, TC-L,
TC-S, TC-D, TC-DD

Magnetic chokes, encapsulated, with reinforced insulation
for class II applications:

- Max. winding temperature $t_w = 130\text{ °C}$
- Plug terminal $0.5 - 1.5\text{ mm}^2$ for rigid wires
- Irreversible thermal cutout
- Trigger value, thermal protection 150 °C

Standards

| | | | | | EN 60921 | EN 61347-1 | EN 61347-2/8 |
|------------|---------|-----------------------|-------------------|---------|----------|------------|--------------|
| Series | Voltage | Connection technology | Type | Page | | | |
| EC | 230 V | push-in terminal | EC 4 – 85 W | Page 8 | • | • | • |
| | | ConCut / IDC terminal | EC 15 – 75 W | Page 10 | • | • | • |
| | 240 V | push-in terminal | EC 4 – 26 W | Page 12 | • | • | • |
| | | ConCut / IDC terminal | EC 15 – 75 W | Page 14 | • | • | • |
| ETAWATT | 230 V | push-in terminal | ETAWATT 18 – 58 W | Page 16 | • | • | • |
| EC – SK II | 230 V | push-in terminal | EC 18 – 28 W | Page 17 | • | | • |

Magnetic chokes for fluorescent lamps

EC magnetic chokes for fluorescent lamps, compact fluorescent lamps and the luminaire insets for compact fluorescent lamps UEC are robust and extremely cost-effective solutions with long lives. The wide range of low-loss chokes in energy efficiency classes B2 and B1 from Tridonic covers all the relevant applications and ensures that the lamps are operated as specified.

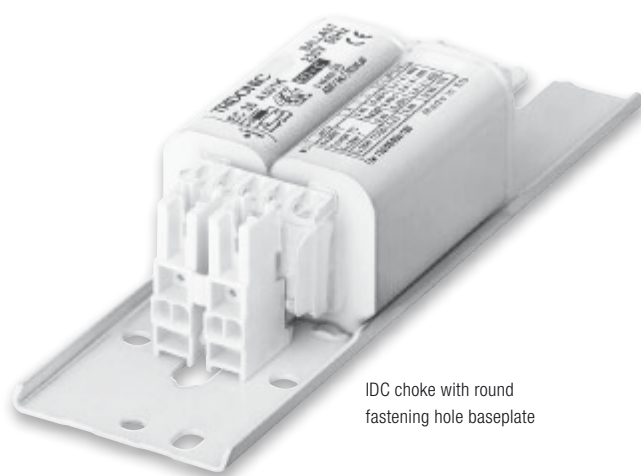

All EC magnetic chokes for luminaire installation are characterised by minimal energy consumption, compact windings, optimised dimensions and high-quality materials.

In temperature-sensitive applications, the EEI = B1 version offers additional benefits thanks to its lower energy consumption and 15 K lower self-heating.

Optimised for specified lamp operation

EC magnetic chokes ensure that the preheating current, ignition voltage and lamp current all remain within the specified tolerances for optimum operation of fluorescent lamps.

Long lamp life can only be achieved by preheating the electrodes before the ignition voltage is applied to the lamp. The EC units heat to precisely the right temperature because if the preheat current is too low or too high the lamp electrodes will be destroyed and the life of the lamp cut short.

The chokes ensure a sufficiently high ignition voltage after the preheat phase by opening a glow starter or electronic starter. The latter automatically selects the right time to open the starter to reliably ignite the lamp at very high or very low ambient temperatures.

The EC chokes are designed to very narrow tolerances so the impedance perfectly limits the lamp current and maximum luminous flux is achieved.

The low magnetic leakage field – and therefore the very low noise emission – means that the magnetic chokes from Tridonic can be placed near electrical equipment that is sensitive to interference.

Design for long life

Because of their high-quality insulation material, coil core and copper wire, chokes in the EC series from Tridonic achieve a nominal life of approximately 100,000 hours of operation, in other words about ten years of constant use at a winding temperature of 130 °C ($t_w = 130$ °C).

The winding temperature is the ambient temperature plus the increase in temperature due to the power consumption of the unit. A change in temperature of 10 °C down or up leads to a doubling or halving of the life of the unit.

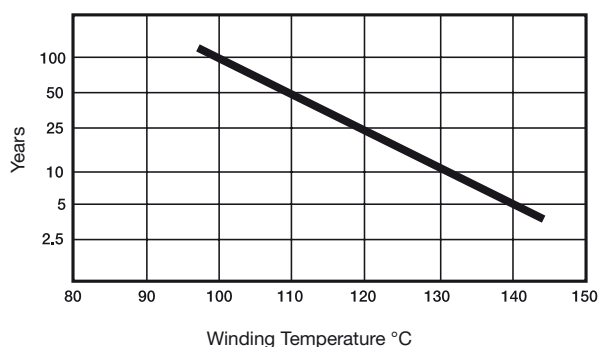

Constant high quality

Uniform high quality standards are guaranteed by the use of high-grade materials together with manufacturing processes certified to ISO 9001. Fully automatic manufacture also ensures constant reproducible quality. All the chokes are subjected to 100 % final testing and safety testing.

Standards and approval marks

EC magnetic chokes from Tridonic are ENEC certified, carry the CE mark and meet all the relevant European as well as international standards relating to safety, operation and electro-magnetic compatibility (EMC).

Lamp matrix

Which control gear for which lamp?

The latest lamp matrix is available on the internet: www.tridonic.com, menu "Technical data", submenu "Lamp matrix"

Technical information

The latest technical information is available on the internet at: www.tridonic.com, menu "Technical data", submenu "Data sheets"

Personal enquiries

A form for personal enquiries is available on the internet at: www.tridonic.com, menu "Contact", submenu "Contact form"

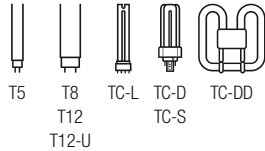

EC 4 – 85 W, push-in terminal 230 V 50 Hz

Product description

- Magnetic chokes for fluorescent lamps
 - Nominal life time 100,000 hours at $t_w = 130\text{ °C}$
 - Additional types on request
- For product data sheet go to www.tridonic.com,
or available on request

Technical data

| | |
|--------------------------------|---|
| Rated voltage | 230 V, 50 Hz |
| Max. winding temperature t_w | 130 °C |
| Push-in terminal | 0.5 – 1.5 mm ² for rigid wires |

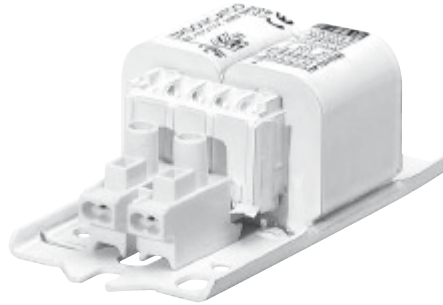

Standards, page 5

Wiring diagrams and installation examples, page 18

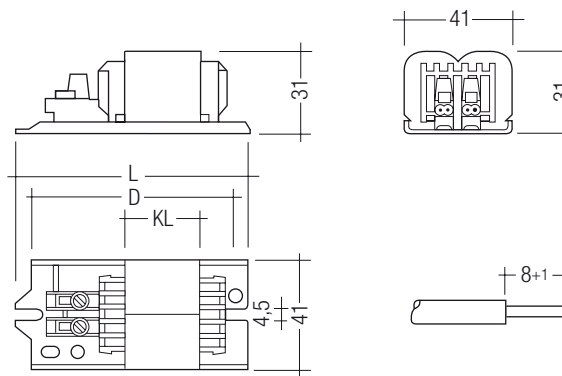

Ordering data

| Type | Article number | Packaging | Packaging, pallet | Weight per piece |
|---|----------------|-------------------|-------------------|------------------|
| Energy Efficiency Index EEI = B2 | | | | |
| EC 8 C101K 230/50 027A084 | 22148945 | 5 pieces strapped | 2,200 pieces | 0.30 kg |
| EC 09 C101K 230/50 027A084 | 22148946 | 5 pieces strapped | 2,200 pieces | 0.30 kg |
| EC 13 C101K 230/50 027A084 | 20821676 | 5 pieces strapped | 2,200 pieces | 0.30 kg |
| EC 16 C101K 230/50 027A084 | 20887799 | 5 pieces strapped | 2,200 pieces | 0.30 kg |
| EC 18 LC111K 230/50 054A110 | 22148943 | 5 pieces strapped | 1,400 pieces | 0.50 kg |
| EC 18 TCD C101K 230/50 027A084 | 20887802 | 5 pieces strapped | 2,200 pieces | 0.30 kg |
| EC 36 LC111K 230/50 054A110 | 22116601 | 5 pieces strapped | 1,400 pieces | 0.50 kg |
| EC 58 C141K 230/50 090A155 | 22175010 | 5 pieces strapped | 1,000 pieces | 0.85 kg |
| EC 80/85 C140 230/50 140A231 | 22175020 | 5 pieces strapped | 600 pieces | 1.30 kg |
| Energy Efficiency Index EEI = B1 | | | | |
| EC 09 B27 230/50 027A084 | 20821657 | 5 pieces strapped | 2,200 pieces | 0.30 kg |
| EC 13 B27 230/50 027A084 | 22116351 | 5 pieces strapped | 2,200 pieces | 0.30 kg |
| EC 16 B27 230/50 027A084 | 20821698 | 5 pieces strapped | 2,200 pieces | 0.30 kg |
| EC 18 B27 230/50 027A084 | 20821714 | 5 pieces strapped | 2,200 pieces | 0.30 kg |
| EC 30 LB103K 230/50 090A151 | 20889548 | 5 pieces strapped | 1,000 pieces | 0.84 kg |
| EC 40 B 90 230/50 090A155 | 20561465 | 5 pieces strapped | 1,000 pieces | 0.83 kg |
| EC 65 B140 230/50 140A231 | 22175030 | 5 pieces strapped | 600 pieces | 1.30 kg |

Specific technical data

| Lamp wattage | Lamp type | Rated lamp current | Type | Article number | Length L | Hole spacing D | Core length KL | ΔT | λ | Compensation, parallel ($\cos \varphi > 0.9$) | |
|---|-----------|--------------------|-----------------|----------------|----------|------------------|----------------|------------|-----------|---|---------------|
| | | | | | | | | | | Capacitor $\pm 10\%$ 250 V | Mains current |
| Energy Efficiency Index EEI = B2 | | | | | | | | | | | |
| 1 x 4 W | T5 | 0.170 A | EC 8 C101K | 22148945 | 84.5 mm | 74.0 – 80.0 mm | 27 mm | 50 K | 0.25 | 2.0 μ F | 0.04 A |
| 1 x 6 W | T5 | 0.160 A | EC 8 C101K | 22148945 | 84.5 mm | 74.0 – 80.0 mm | 27 mm | 45 K | 0.30 | 2.0 μ F | 0.05 A |
| 1 x 8 W | T5 | 0.145 A | EC 8 C101K | 22148945 | 84.5 mm | 74.0 – 80.0 mm | 27 mm | 45 K | 0.35 | 2.0 μ F | 0.06 A |
| 2 x 6 W | T5 | 0.160 A | EC 8 C101K | 22148945 | 84.5 mm | 74.0 – 80.0 mm | 27 mm | 40 K | 0.44 | 2.0 μ F | 0.05 A |
| 2 x 4 W | T5 | 0.170 A | EC 8 C101K | 22148945 | 84.5 mm | 74.0 – 80.0 mm | 27 mm | 40 K | 0.34 | 2.0 μ F | 0.05 A |
| 1 x 5 W | TC-S | 0.180 A | EC 09 C101K | 22148946 | 84.5 mm | 74.0 – 80.0 mm | 27 mm | 50 K | 0.28 | 2.0 μ F | 0.05 A |
| 1 x 7 W | TC-S | 0.175 A | EC 09 C101K | 22148946 | 84.5 mm | 74.0 – 80.0 mm | 27 mm | 50 K | 0.32 | 2.0 μ F | 0.05 A |
| 1 x 9 W | TC-S | 0.170 A | EC 09 C101K | 22148946 | 84.5 mm | 74.0 – 80.0 mm | 27 mm | 50 K | 0.36 | 2.0 μ F | 0.06 A |
| 1 x 11 W | TC-S | 0.155 A | EC 09 C101K | 22148946 | 84.5 mm | 74.0 – 80.0 mm | 27 mm | 40 K | 0.47 | 2.0 μ F | 0.07 A |
| 1 x 13 W | T5 | 0.165 A | EC 13 C101K | 20821676 | 84.5 mm | 74.0 – 80.0 mm | 27 mm | 45 K | 0.45 | 2.0 μ F | 0.08 A |
| 1 x 10 W | T8 | 0.170 A | EC 13 C101K | 20821676 | 84.5 mm | 74.0 – 80.0 mm | 27 mm | 45 K | 0.37 | 2.0 μ F | 0.07 A |
| 1 x 13 W | TC-D | 0.165 A | EC 13 C101K | 20821676 | 84.5 mm | 74.0 – 80.0 mm | 27 mm | 50 K | 0.45 | 2.0 μ F | 0.08 A |
| 1 x 10 W | TC-D | 0.180 A | EC 13 C101K | 20821676 | 84.5 mm | 74.0 – 80.0 mm | 27 mm | 55 K | 0.37 | 2.0 μ F | 0.07 A |
| 1 x 10 W | TC-DD | 0.180 A | EC 13 C101K | 20821676 | 84.5 mm | 74.0 – 80.0 mm | 27 mm | 50 K | 0.39 | 2.0 μ F | 0.07 A |
| 2 x 8 W | T5 | 0.145 A | EC 13 C101K | 20821676 | 84.5 mm | 74.0 – 80.0 mm | 27 mm | 35 K | 0.60 | 2.0 μ F | 0.09 A |
| 2 x 7 W | TC-S | 0.175 A | EC 13 C101K | 20821676 | 84.5 mm | 74.0 – 80.0 mm | 27 mm | 50 K | 0.46 | 2.0 μ F | 0.08 A |
| 2 x 9 W | TC-S | 0.170 A | EC 13 C101K | 20821676 | 84.5 mm | 74.0 – 80.0 mm | 27 mm | 45 K | 0.57 | 1.5 μ F | 0.08 A |
| 1 x 16 W | T8 | 0.200 A | EC 16 C101K | 20887799 | 84.5 mm | 74.0 – 80.0 mm | 27 mm | 50 K | 0.48 | 2.0 μ F | 0.09 A |
| 1 x 16 W | TC-DD | 0.195 A | EC 16 C101K | 20887799 | 84.5 mm | 74.0 – 80.0 mm | 27 mm | 50 K | 0.48 | 2.0 μ F | 0.09 A |
| 1 x 18 W | T8 | 0.370 A | EC 18 LC111K | 22148943 | 110.0 mm | 97.0 – 105.0 mm | 54 mm | 55 K | 0.32 | 4.5 μ F | 0.13 A |
| 1 x 23 W | T8 | 0.290 A | EC 18 LC111K | 22148943 | 110.0 mm | 97.0 – 105.0 mm | 54 mm | 45 K | 0.40 | 3.5 μ F | 0.12 A |
| 1 x 18 W | TC-D | 0.220 A | EC 18 TCD C101K | 20887802 | 84.5 mm | 74.0 – 80.0 mm | 27 mm | 55 K | 0.49 | 2.0 μ F | 0.11 A |
| 1 x 36 W | T8 | 0.430 A | EC 36 LC111K | 22116601 | 110.0 mm | 97.0 – 105.0 mm | 54 mm | 55 K | 0.46 | 4.5 μ F | 0.22 A |
| 1 x 38 W | T8 | 0.430 A | EC 36 LC111K | 22116601 | 110.0 mm | 97.0 – 105.0 mm | 54 mm | 55 K | 0.49 | 4.5 μ F | 0.23 A |
| 1 x 58 W | T8 | 0.670 A | EC 58 C141K | 22175010 | 155.0 mm | 137.5 – 153.5 mm | 90 mm | 50 K | 0.46 | 7.0 μ F | 0.67 A |
| 1 x 80 W | T12 | 0.870 A | EC 80/85 C140 | 22175020 | 231.0 mm | 210.0 – 224.0 mm | 140 mm | 45 K | 0.46 | 8.0 μ F | 0.46 A |
| 1 x 85 W | T12 | 0.800 A | EC 80/85 C140 | 22175020 | 231.0 mm | 210.0 – 224.0 mm | 140 mm | 40 K | 0.53 | 8.0 μ F | 0.47 A |
| Energy Efficiency Index EEI = B1 | | | | | | | | | | | |
| 1 x 5 W | TC-S | 0.180 A | EC 09 B27 | 20821657 | 84.5 mm | 74.0 – 80.0 mm | 27 mm | 40 K | 0.25 | 2.0 μ F | 0.05 A |
| 1 x 7 W | TC-S | 0.175 A | EC 09 B27 | 20821657 | 84.5 mm | 74.0 – 80.0 mm | 27 mm | 40 K | 0.30 | 2.0 μ F | 0.05 A |
| 1 x 9 W | TC-S | 0.170 A | EC 09 B27 | 20821657 | 84.5 mm | 74.0 – 80.0 mm | 27 mm | 35 K | 0.34 | 2.0 μ F | 0.06 A |
| 1 x 11 W | TC-S | 0.155 A | EC 09 B27 | 20821657 | 84.5 mm | 74.0 – 80.0 mm | 27 mm | 35 K | 0.43 | 2.0 μ F | 0.07 A |
| 1 x 13 W | T5 | 0.165 A | EC 13 B27 | 22116351 | 84.5 mm | 74.0 – 80.0 mm | 27 mm | 35 K | 0.46 | 2.0 μ F | 0.08 A |
| 1 x 10 W | T8 | 0.170 A | EC 13 B27 | 22116351 | 84.5 mm | 74.0 – 80.0 mm | 27 mm | 40 K | 0.35 | 2.0 μ F | 0.07 A |
| 1 x 10 W | TC-D | 0.180 A | EC 13 B27 | 22116351 | 84.5 mm | 74.0 – 80.0 mm | 27 mm | 40 K | 0.38 | 2.0 μ F | 0.06 A |
| 1 x 13 W | TC-D | 0.165 A | EC 13 B27 | 22116351 | 84.5 mm | 74.0 – 80.0 mm | 27 mm | 40 K | 0.44 | 2.0 μ F | 0.07 A |
| 2 x 8 W | T5 | 0.145 A | EC 13 B27 | 22116351 | 84.5 mm | 74.0 – 80.0 mm | 27 mm | 30 K | 0.55 | 2.0 μ F | 0.09 A |
| 2 x 7 W | TC-S | 0.175 A | EC 13 B27 | 22116351 | 84.5 mm | 74.0 – 80.0 mm | 27 mm | 40 K | 0.45 | 2.0 μ F | 0.07 A |
| 2 x 9 W | TC-S | 0.170 A | EC 13 B27 | 22116351 | 84.5 mm | 74.0 – 80.0 mm | 27 mm | 35 K | 0.55 | 1.5 μ F | 0.09 A |
| 1 x 16 W | TC-DD | 0.195 A | EC 16 B27 | 20821698 | 84.5 mm | 74.0 – 80.0 mm | 27 mm | 45 K | 0.45 | 2.0 μ F | 0.10 A |
| 1 x 18 W | TC-D | 0.220 A | EC 18 B27 | 20821714 | 84.5 mm | 74.0 – 80.0 mm | 27 mm | 50 K | 0.47 | 2.0 μ F | 0.11 A |
| 1 x 30 W | T8 | 0.365 A | EC 30 LB103K | 20889548 | 151.0 mm | 110.0 – 144.0 mm | 90 mm | 35 K | 0.36 | 4.5 μ F | 0.17 A |
| 2 x 15 W | T8 | 0.310 A | EC 30 LB103K | 20889548 | 151.0 mm | 110.0 – 144.0 mm | 90 mm | 35 K | 0.49 | 4.5 μ F | 0.18 A |
| 1 x 36 W | T8 | 0.430 A | EC 40 B 90 | 20561465 | 155.0 mm | 137.5 – 153.5 mm | 90 mm | 30 K | 0.43 | 4.5 μ F | 0.22 A |
| 1 x 36 W | TC-L | 0.430 A | EC 40 B 90 | 20561465 | 155.0 mm | 137.5 – 153.5 mm | 90 mm | 40 K | 0.45 | 4.5 μ F | 0.22 A |
| 1 x 65 W | T12-U | 0.670 A | EC 65 B140 | 22175030 | 231.0 mm | 210.0 – 224.0 mm | 140 mm | 30 K | 0.49 | 7.0 μ F | 0.32 A |
| 1 x 58 W | T8 | 0.670 A | EC 65 B140 | 22175030 | 231.0 mm | 210.0 – 224.0 mm | 140 mm | 30 K | 0.45 | 7.0 μ F | 0.32 A |

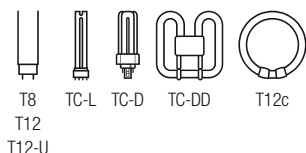

EC 15 – 75 W, ConCut / IDC terminal
230 V 50 Hz

Product description

- Magnetic chokes for fluorescent lamps
 - Nominal life time 100,000 hours at $t_w = 130\text{ °C}$
 - Additional types on request
- For product data sheet go to www.tridonic.com, or available on request

Technical data

| | |
|---|---------------------------|
| Rated voltage | 230 V, 50 Hz |
| Max. winding temperature t_w | 130 °C |
| ConCut (insulation displacement connection) | 0.5 – 1.5 mm ² |



Standards, page 5

Wiring diagrams and installation examples, page 18

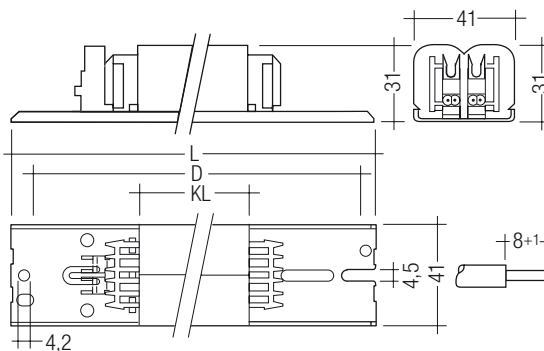

Ordering data

| Type | Article number | Packaging | Packaging, pallet | Weight per piece |
|---|----------------|-------------------|-------------------|------------------|
| Energy Efficiency Index EEI = B2 | | | | |
| EC 15 OC501K 230/50 040A151 | 22175125 | 5 pieces strapped | 1,400 pieces | 0.52 kg |
| EC 15 C501K 230/50 050A151 | 22148747 | 5 pieces strapped | 1,400 pieces | 0.50 kg |
| EC 2x18 OC501K 230/50 040A151 | 22175112 | 5 pieces strapped | 1,400 pieces | 0.43 kg |
| EC 18 C501K 230/50 050A151 | 22175069 | 5 pieces strapped | 1,400 pieces | 0.50 kg |
| EC 18 LC501K 230/50 054A151 | 22115859 | 5 pieces strapped | 1,400 pieces | 0.55 kg |
| EC 21 C501K 230/50 050A151 | 22148753 | 5 pieces strapped | 1,400 pieces | 0.50 kg |
| EC 26 TCD OC111K 230/50 040A110 IDC | 22175185 | 5 pieces strapped | 1,800 pieces | 0.50 kg |
| EC 26 OC101K 230/50 050A110 IDC | 22148858 | 5 pieces strapped | 1,400 pieces | 0.53 kg |
| EC 30 C501K 230/50 050A151 | 22148755 | 5 pieces strapped | 1,400 pieces | 0.50 kg |
| EC 32 C501K 230/50 090A191 | 22149052 | 5 pieces strapped | 1,000 pieces | 0.85 kg |
| EC 36 C501K 230/50 050A151 | 22175058 | 5 pieces strapped | 1,400 pieces | 0.51 kg |
| EC 36 LC501K 230/50 054A151 | 22115862 | 5 pieces strapped | 1,400 pieces | 0.55 kg |
| EC 36-1 C501K 230/50 100A191 LOSE | 22149284 | 5 pieces strapped | 1,000 pieces | 1.00 kg |
| EC 58 C501K 230/50 090A191 | 22115907 | 5 pieces strapped | 1,000 pieces | 0.85 kg |
| EC 58 LC501K 230/50 100A191 | 22148638 | 5 pieces strapped | 1,000 pieces | 0.90 kg |
| EC 70 C501K 230/50 090A191D | 22148762 | 5 pieces strapped | 1,000 pieces | 0.88 kg |
| EC 70 LC501K 230/50 100A191D | 22149286 | 5 pieces strapped | 1,000 pieces | 0.95 kg |
| Energy Efficiency Index EEI = B1 | | | | |
| EC 18 B 50 230/50 050A110 IDC | 22117273 | 5 pieces strapped | 1,600 pieces | 0.50 kg |
| EC 18 B501K 230/50 090A191 | 22148749 | 5 pieces strapped | 1,000 pieces | 0.85 kg |
| EC 20 B 90 230/50 090A155 IDC | 22116988 | 5 pieces strapped | 1,000 pieces | 0.84 kg |
| EC 30 B501K 230/50 054A151 | 22148754 | 5 pieces strapped | 1,400 pieces | 0.55 kg |
| EC 36 B501K 230/50 090A191 | 22148758 | 5 pieces strapped | 1,000 pieces | 0.85 kg |

Specific technical data

| Lamp wattage | Lamp type | Rated lamp current | Type | Article number | Length L | Hole spacing D | Core length KL | Δ T | λ | Compensation, parallel (cos φ > 0.9) | |
|---|-----------|--------------------|------------------|----------------|----------|------------------|----------------|------|------|--------------------------------------|---------------|
| | | | | | | | | | | Capacitor ± 10 % 250 V | Mains current |
| Energy Efficiency Index EEI = B2 | | | | | | | | | | | |
| 1 x 15 W | T8 | 0.310 A | EC 15 OC501K | 22175125 | 151 mm | 110.0 – 144.0 mm | 40 mm | 60 K | 0.33 | 4.5 µF | 0.12 A |
| 1 x 15 W | T8 | 0.310 A | EC 15 C501K | 22148747 | 151 mm | 110.0 – 144.0 mm | 50 mm | 50 K | 0.33 | 4.5 µF | 0.12 A |
| 2 x 18 W | T8 | 0.370 A | EC 2x18 OC501K | 22175112 | 151 mm | 110.0 – 144.0 mm | 40 mm | 55 K | 0.52 | 4.5 µF | 0.22 A |
| 1 x 18 W | T8 | 0.370 A | EC 18 C501K | 22175069 | 151 mm | 110.0 – 144.0 mm | 50 mm | 55 K | 0.33 | 4.5 µF | 0.13 A |
| 1 x 18 W | T8 | 0.370 A | EC 18 LC501K | 22115859 | 151 mm | 110.0 – 144.0 mm | 54 mm | 55 K | 0.32 | 4.5 µF | 0.13 A |
| 1 x 23 W | T8 | 0.290 A | EC 18 LC501K | 22115859 | 151 mm | 110.0 – 144.0 mm | 54 mm | 45 K | 0.40 | 3.5 µF | 0.12 A |
| 1 x 26 W | TC-D | 0.325 A | EC 18 LC501K | 22115859 | 151 mm | 110.0 – 144.0 mm | 54 mm | 45 K | 0.43 | 3.0 µF | 0.15 A |
| 1 x 28 W | TC-DD | 0.320 A | EC 18 LC501K | 22115859 | 151 mm | 110.0 – 144.0 mm | 54 mm | 45 K | 0.49 | 3.0 µF | 0.15 A |
| 1 x 18 W | TC-L | 0.370 A | EC 18 LC501K | 22115859 | 151 mm | 110.0 – 144.0 mm | 54 mm | 55 K | 0.33 | 4.5 µF | 0.13 A |
| 1 x 24 W | TC-L | 0.345 A | EC 18 LC501K | 22115859 | 151 mm | 110.0 – 144.0 mm | 54 mm | 50 K | 0.38 | 3.0 µF | 0.15 A |
| 1 x 21 W | TC-DD | 0.260 A | EC 21 C501K | 22148753 | 151 mm | 110.0 – 144.0 mm | 50 mm | 35 K | 0.42 | 3.0 µF | 0.11 A |
| 1 x 26 W | TC-D | 0.325 A | EC 26 TCD OC111K | 22175185 | 110 mm | 97.0 – 105.0 mm | 40 mm | 65 K | 0.32 | 3.5 µF | 0.14 A |
| 1 x 26 W | TC-D | 0.325 A | EC 26 OC101K | 22148858 | 110 mm | 97.0 – 105.0 mm | 50 mm | 45 K | 0.43 | 3.0 µF | 0.15 A |
| 1 x 24 W | TC-L | 0.345 A | EC 26 OC101K | 22148858 | 110 mm | 97.0 – 105.0 mm | 50 mm | 50 K | 0.40 | 3.0 µF | 0.15 A |
| 1 x 30 W | T8 | 0.365 A | EC 30 C501K | 22148755 | 151 mm | 110.0 – 144.0 mm | 50 mm | 60 K | 0.47 | 4.5 µF | 0.17 A |
| 2 x 15 W | T8 | 0.310 A | EC 30 C501K | 22148755 | 151 mm | 110.0 – 144.0 mm | 50 mm | 50 K | 0.49 | 4.5 µF | 0.18 A |
| 1 x 32 W | T12c | 0.450 A | EC 32 C501K | 22149052 | 191 mm | 150.0 – 184.0 mm | 90 mm | 35 K | 0.40 | 5.0 µF | 0.18 A |
| 1 x 36 W | T8 | 0.430 A | EC 36 C501K | 22175058 | 151 mm | 110.0 – 144.0 mm | 50 mm | 50 K | 0.47 | 4.5 µF | 0.22 A |
| 2 x 18 W | T8 | 0.370 A | EC 36 C501K | 22175058 | 151 mm | 110.0 – 144.0 mm | 50 mm | 50 K | 0.50 | 4.5 µF | 0.22 A |
| 1 x 40 W | T12-U | 0.430 A | EC 36 LC501K | 22115862 | 151 mm | 110.0 – 144.0 mm | 54 mm | 55 K | 0.51 | 4.5 µF | 0.24 A |
| 1 x 40 W | T12c | 0.415 A | EC 36 LC501K | 22115862 | 151 mm | 110.0 – 144.0 mm | 54 mm | 55 K | 0.51 | 4.5 µF | 0.24 A |
| 1 x 36 W | T8 | 0.430 A | EC 36 LC501K | 22115862 | 151 mm | 110.0 – 144.0 mm | 54 mm | 55 K | 0.46 | 4.5 µF | 0.22 A |
| 1 x 38 W | T8 | 0.430 A | EC 36 LC501K | 22115862 | 151 mm | 110.0 – 144.0 mm | 54 mm | 55 K | 0.49 | 4.5 µF | 0.23 A |
| 1 x 38 W | TC-DD | 0.430 A | EC 36 LC501K | 22115862 | 151 mm | 110.0 – 144.0 mm | 54 mm | 50 K | 0.49 | 4.5 µF | 0.23 A |
| 1 x 36 W | TC-L | 0.430 A | EC 36 LC501K | 22115862 | 151 mm | 110.0 – 144.0 mm | 54 mm | 55 K | 0.44 | 4.5 µF | 0.22 A |
| 2 x 18 W | T8 | 0.370 A | EC 36 LC501K | 22115862 | 151 mm | 110.0 – 144.0 mm | 54 mm | 50 K | 0.52 | 4.5 µF | 0.22 A |
| 2 x 18 W | TC-L | 0.370 A | EC 36 LC501K | 22115862 | 151 mm | 110.0 – 144.0 mm | 54 mm | 50 K | 0.44 | 4.5 µF | 0.20 A |
| 1 x 40 W | T12c | 0.415 A | EC 36-1 C501K | 22149284 | 191 mm | 150.0 – 184.0 mm | 100 mm | 40 K | 0.34 | 6.0 µF | 0.21 A |
| 1 x 36 W | T8 | 0.430 A | EC 36-1 C501K | 22149284 | 191 mm | 150.0 – 184.0 mm | 100 mm | 40 K | 0.34 | 6.0 µF | 0.21 A |
| 1 x 58 W | T8 | 0.670 A | EC 58 C501K | 22115907 | 191 mm | 150.0 – 184.0 mm | 90 mm | 50 K | 0.47 | 7.0 µF | 0.32 A |
| 1 x 58 W | T8 | 0.670 A | EC 58 LC501K | 22148638 | 191 mm | 150.0 – 184.0 mm | 100 mm | 45 K | 0.47 | 7.0 µF | 0.31 A |
| 1 x 75 W | T12 | 0.670 A | EC 70 C501K | 22148762 | 191 mm | 150.0 – 184.0 mm | 90 mm | 45 K | 0.55 | 6.0 µF | 0.39 A |
| 1 x 70 W | T8 | 0.700 A | EC 70 C501K | 22148762 | 191 mm | 150.0 – 184.0 mm | 90 mm | 45 K | 0.52 | 7.0 µF | 0.37 A |
| 1 x 75 W | T12 | 0.670 A | EC 70 LC501K | 22149286 | 191 mm | 150.0 – 184.0 mm | 100 mm | 50 K | 0.56 | 6.0 µF | 0.39 A |
| 1 x 70 W | T8 | 0.700 A | EC 70 LC501K | 22149286 | 191 mm | 150.0 – 184.0 mm | 100 mm | 50 K | 0.51 | 7.0 µF | 0.37 A |
| Energy Efficiency Index EEI = B1 | | | | | | | | | | | |
| 1 x 18 W | TC-D | 0.220 A | EC 18 B 50 | 22117273 | 110 mm | 97.0 – 105.0 mm | 50 mm | 25 K | 0.42 | 2.0 µF | 0.10 A |
| 1 x 18 W | T8 | 0.370 A | EC 18 B501K | 22148749 | 191 mm | 150.0 – 184.0 mm | 90 mm | 35 K | 0.30 | 4.5 µF | 0.13 A |
| 1 x 23 W | T8 | 0.290 A | EC 18 B501K | 22148749 | 191 mm | 150.0 – 184.0 mm | 90 mm | 30 K | 0.40 | 3.0 µF | 0.14 A |
| 1 x 26 W | TC-D | 0.325 A | EC 18 B501K | 22148749 | 191 mm | 150.0 – 184.0 mm | 90 mm | 30 K | 0.43 | 3.0 µF | 0.14 A |
| 1 x 28 W | TC-DD | 0.320 A | EC 18 B501K | 22148749 | 191 mm | 150.0 – 184.0 mm | 90 mm | 30 K | 0.46 | 3.0 µF | 0.15 A |
| 1 x 18 W | TC-L | 0.370 A | EC 18 B501K | 22148749 | 191 mm | 150.0 – 184.0 mm | 90 mm | 40 K | 0.29 | 4.5 µF | 0.10 A |
| 1 x 24 W | TC-L | 0.345 A | EC 18 B501K | 22148749 | 191 mm | 150.0 – 184.0 mm | 90 mm | 30 K | 0.39 | 3.0 µF | 0.13 A |
| 1 x 18 W | T8 | 0.370 A | EC 20 B 90 | 22116988 | 155 mm | 137.5 – 153.5 mm | 90 mm | 30 K | 0.30 | 4.5 µF | 0.13 A |
| 1 x 26 W | TC-D | 0.325 A | EC 20 B 90 | 22116988 | 155 mm | 137.5 – 153.5 mm | 90 mm | 35 K | 0.38 | 3.5 µF | 0.14 A |
| 1 x 18 W | TC-L | 0.370 A | EC 20 B 90 | 22116988 | 155 mm | 137.5 – 153.5 mm | 90 mm | 30 K | 0.29 | 4.5 µF | 0.13 A |
| 1 x 30 W | T8 | 0.365 A | EC 30 B501K | 22148754 | 151 mm | 110.0 – 144.0 mm | 54 mm | 45 K | 0.44 | 4.5 µF | 0.17 A |
| 2 x 15 W | T8 | 0.310 A | EC 30 B501K | 22148754 | 151 mm | 110.0 – 144.0 mm | 54 mm | 50 K | 0.44 | 4.5 µF | 0.18 A |
| 1 x 40 W | T12-U | 0.430 A | EC 36 B501K | 22148758 | 191 mm | 150.0 – 184.0 mm | 90 mm | 30 K | 0.43 | 4.5 µF | 0.24 A |
| 1 x 40 W | T12c | 0.415 A | EC 36 B501K | 22148758 | 191 mm | 150.0 – 184.0 mm | 90 mm | 30 K | 0.43 | 4.5 µF | 0.24 A |
| 1 x 36 W | T8 | 0.430 A | EC 36 B501K | 22148758 | 191 mm | 150.0 – 184.0 mm | 90 mm | 30 K | 0.43 | 4.5 µF | 0.22 A |
| 1 x 38 W | T8 | 0.430 A | EC 36 B501K | 22148758 | 191 mm | 150.0 – 184.0 mm | 90 mm | 30 K | 0.45 | 4.5 µF | 0.22 A |
| 1 x 38 W | TC-DD | 0.430 A | EC 36 B501K | 22148758 | 191 mm | 150.0 – 184.0 mm | 90 mm | 30 K | 0.45 | 4.5 µF | 0.22 A |
| 1 x 36 W | TC-L | 0.430 A | EC 36 B501K | 22148758 | 191 mm | 150.0 – 184.0 mm | 90 mm | 30 K | 0.44 | 4.5 µF | 0.22 A |
| 2 x 18 W | T8 | 0.370 A | EC 36 B501K | 22148758 | 191 mm | 150.0 – 184.0 mm | 90 mm | 30 K | 0.45 | 4.5 µF | 0.22 A |
| 2 x 18 W | TC-L | 0.370 A | EC 36 B501K | 22148758 | 191 mm | 150.0 – 184.0 mm | 90 mm | 30 K | 0.46 | 4.5 µF | 0.20 A |

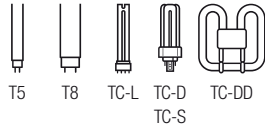

EC 4 – 26 W, push-in terminal
240 V 50 Hz

Product description

- Magnetic chokes for fluorescent lamps
 - Nominal life time 100,000 hours at $t_w = 130\text{ °C}$
 - Additional types on request
- For product data sheet go to www.tridonic.com, or available on request

Technical data

| | |
|--------------------------------|---|
| Rated voltage | 240 V, 50 Hz |
| Max. winding temperature t_w | 130 °C |
| Push-in terminal | 0.5 – 1.5 mm ² for rigid wires |

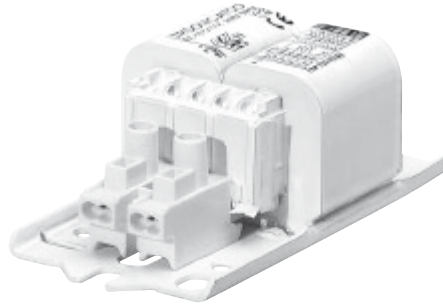

Standards, page 5

Wiring diagrams and installation examples, page 18

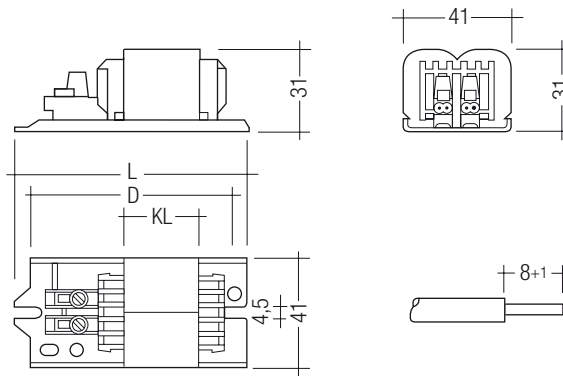

Ordering data

| Type | Article number | Packaging | Packaging, pallet | Weight per piece |
|---|----------------|-------------------|-------------------|------------------|
| Energy Efficiency Index EEI = B2 | | | | |
| EC 8 C102K 240/50 027A084 | 22148939 | 5 pieces strapped | 2,200 pieces | 0.30 kg |
| EC 09 C102K 240/50 027A084 | 22149307 | 5 pieces strapped | 2,200 pieces | 0.30 kg |
| EC 13 C102K 240/50 027A084 | 20821682 | 5 pieces strapped | 2,200 pieces | 0.33 kg |
| EC 16 C102K 240/50 027A084 | 22115480 | 5 pieces strapped | 2,200 pieces | 0.30 kg |
| EC 18 TCD C102K 240/50 027A084 | 22149235 | 5 pieces strapped | 2,200 pieces | 0.30 kg |
| EC 26 LC102K 240/50 054A110 | 20889280 | 5 pieces strapped | 1,400 pieces | 0.53 kg |
| Energy Efficiency Index EEI = B1 | | | | |
| EC 09 B27 240/50 027A084 | 20821660 | 5 pieces strapped | 2,200 pieces | 0.30 kg |
| EC 18 B27 240/50 027A084 | 20821720 | 5 pieces strapped | 2,200 pieces | 0.30 kg |

Specific technical data

| Lamp wattage | Lamp type | Rated lamp current | Type | Article number | Length L | Hole spacing D | Core length KL | ΔT | λ | Compensation, parallel ($\cos \varphi > 0.9$) | |
|---|-----------|--------------------|-----------------|----------------|----------|----------------|----------------|------------|-----------|---|---------------|
| | | | | | | | | | | Capacitor $\pm 10\%$ 250 V | Mains current |
| Energy Efficiency Index EEI = B2 | | | | | | | | | | | |
| 1 x 4 W | T5 | 0.170 A | EC 8 C102K | 22148939 | 84.5 mm | 74 – 80 mm | 27 mm | 55 K | 0.25 | 2.0 μ F | 0.04 A |
| 1 x 6 W | T5 | 0.160 A | EC 8 C102K | 22148939 | 84.5 mm | 74 – 80 mm | 27 mm | 45 K | 0.28 | 2.0 μ F | 0.05 A |
| 1 x 8 W | T5 | 0.145 A | EC 8 C102K | 22148939 | 84.5 mm | 74 – 80 mm | 27 mm | 45 K | 0.38 | 2.0 μ F | 0.06 A |
| 2 x 6 W | T5 | 0.160 A | EC 8 C102K | 22148939 | 84.5 mm | 74 – 80 mm | 27 mm | 40 K | 0.44 | 2.0 μ F | 0.05 A |
| 2 x 4 W | T5 | 0.170 A | EC 8 C102K | 22148939 | 84.5 mm | 74 – 80 mm | 27 mm | 45 K | 0.34 | 2.0 μ F | 0.05 A |
| 1 x 5 W | TC-S | 0.180 A | EC 09 C102K | 22149307 | 84.5 mm | 74 – 80 mm | 27 mm | 60 K | 0.28 | 2.0 μ F | 0.05 A |
| 1 x 7 W | TC-S | 0.175 A | EC 09 C102K | 22149307 | 84.5 mm | 74 – 80 mm | 27 mm | 55 K | 0.31 | 2.0 μ F | 0.05 A |
| 1 x 9 W | TC-S | 0.170 A | EC 09 C102K | 22149307 | 84.5 mm | 74 – 80 mm | 27 mm | 50 K | 0.36 | 2.0 μ F | 0.06 A |
| 1 x 11 W | TC-S | 0.155 A | EC 09 C102K | 22149307 | 84.5 mm | 74 – 80 mm | 27 mm | 40 K | 0.44 | 2.0 μ F | 0.07 A |
| 1 x 13 W | T5 | 0.165 A | EC 13 C102K | 20821682 | 84.5 mm | 74 – 80 mm | 27 mm | 40 K | 0.45 | 2.0 μ F | 0.07 A |
| 1 x 10 W | T8 | 0.170 A | EC 13 C102K | 20821682 | 84.5 mm | 74 – 80 mm | 27 mm | 40 K | 0.37 | 2.0 μ F | 0.07 A |
| 1 x 10 W | TC-D | 0.180 A | EC 13 C102K | 20821682 | 84.5 mm | 74 – 80 mm | 27 mm | 50 K | 0.36 | 2.0 μ F | 0.07 A |
| 1 x 13 W | TC-D | 0.165 A | EC 13 C102K | 20821682 | 84.5 mm | 74 – 80 mm | 27 mm | 45 K | 0.45 | 2.0 μ F | 0.08 A |
| 1 x 10 W | TC-DD | 0.180 A | EC 13 C102K | 20821682 | 84.5 mm | 74 – 80 mm | 27 mm | 45 K | 0.36 | 2.0 μ F | 0.07 A |
| 2 x 8 W | T5 | 0.145 A | EC 13 C102K | 20821682 | 84.5 mm | 74 – 80 mm | 27 mm | 30 K | 0.49 | 2.0 μ F | 0.09 A |
| 2 x 7 W | TC-S | 0.175 A | EC 13 C102K | 20821682 | 84.5 mm | 74 – 80 mm | 27 mm | 40 K | 0.45 | 2.0 μ F | 0.08 A |
| 2 x 9 W | TC-S | 0.170 A | EC 13 C102K | 20821682 | 84.5 mm | 74 – 80 mm | 27 mm | 40 K | 0.52 | 2.0 μ F | 0.08 A |
| 1 x 16 W | T8 | 0.200 A | EC 16 C102K | 22115480 | 84.5 mm | 74 – 80 mm | 27 mm | 55 K | 0.46 | 2.0 μ F | 0.09 A |
| 1 x 16 W | TC-DD | 0.195 A | EC 16 C102K | 22115480 | 84.5 mm | 74 – 80 mm | 27 mm | 55 K | 0.46 | 2.0 μ F | 0.09 A |
| 1 x 18 W | TC-D | 0.220 A | EC 18 TCD C102K | 22149235 | 84.5 mm | 74 – 80 mm | 27 mm | 55 K | 0.46 | 2.0 μ F | 0.10 A |
| 1 x 26 W | TC-D | 0.325 A | EC 26 LC102K | 20889280 | 110.0 mm | 97 – 105 mm | 54 mm | 50 K | 0.42 | 3.5 μ F | 0.14 A |
| 1 x 24 W | TC-L | 0.345 A | EC 26 LC102K | 20889280 | 110.0 mm | 97 – 105 mm | 54 mm | 50 K | 0.39 | 4.0 μ F | 0.13 A |
| Energy Efficiency Index EEI = B1 | | | | | | | | | | | |
| 1 x 5 W | TC-S | 0.180 A | EC 09 B27 | 20821660 | 84.5 mm | 74 – 80 mm | 27 mm | 50 K | 0.25 | 2.0 μ F | 0.05 A |
| 1 x 7 W | TC-S | 0.175 A | EC 09 B27 | 20821660 | 84.5 mm | 74 – 80 mm | 27 mm | 45 K | 0.29 | 2.0 μ F | 0.05 A |
| 1 x 9 W | TC-S | 0.170 A | EC 09 B27 | 20821660 | 84.5 mm | 74 – 80 mm | 27 mm | 40 K | 0.34 | 2.0 μ F | 0.06 A |
| 1 x 11 W | TC-S | 0.155 A | EC 09 B27 | 20821660 | 84.5 mm | 74 – 80 mm | 27 mm | 40 K | 0.39 | 2.0 μ F | 0.07 A |
| 1 x 18 W | TC-D | 0.220 A | EC 18 B27 | 20821720 | 84.5 mm | 74 – 80 mm | 27 mm | 60 K | 0.44 | 2.0 μ F | 0.10 A |

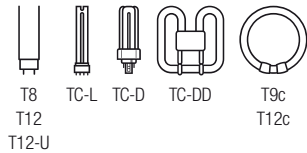

EC 15 – 75 W, ConCut / IDC terminal
240 V 50 Hz

Product description

- Magnetic chokes for fluorescent lamps
 - Nominal life time 100,000 hours at $t_w = 130\text{ °C}$
 - Additional types on request
- For product data sheet go to www.tridonic.com, or available on request

Technical data

| | |
|---|---------------------------|
| Rated voltage | 240 V, 50 Hz |
| Max. winding temperature t_w | 130 °C |
| ConCut (insulation displacement connection) | 0.5 – 1.5 mm ² |



Standards, page 5

Wiring diagrams and installation examples, page 18

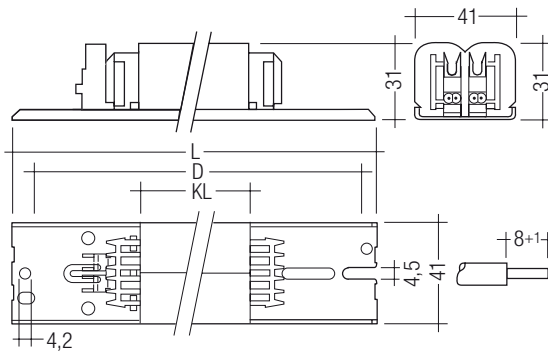

Ordering data

| Type | Article number | Packaging | Packaging, pallet | Weight per piece |
|---|----------------|-------------------|-------------------|------------------|
| Energy Efficiency Index EEI = B2 | | | | |
| EC 15 C502K 240/50 050A151 | 22149234 | 5 pieces strapped | 1,400 pieces | 0.50 kg |
| EC 2x18 OC502K 240/50 040A151 | 22175106 | 5 pieces strapped | 1,400 pieces | 0.43 kg |
| EC 18 C502K 240/50 050A151 | 22175070 | 5 pieces strapped | 1,400 pieces | 0.51 kg |
| EC 18 LC502K 240/50 054A151 | 22148708 | 5 pieces strapped | 1,400 pieces | 0.54 kg |
| EC 30 C502K 240/50 050A151 | 22149241 | 5 pieces strapped | 1,400 pieces | 0.50 kg |
| EC 36 C502K 240/50 050A151 | 22175071 | 5 pieces strapped | 1,400 pieces | 0.52 kg |
| EC 36 LC502K 240/50 054A151 | 22148709 | 5 pieces strapped | 1,400 pieces | 0.55 kg |
| EC 58 C502K 240/50 090A191 | 22149260 | 5 pieces strapped | 1,000 pieces | 0.87 kg |
| EC 70 C502K 240/50 090A191D | 22148773 | 5 pieces strapped | 1,000 pieces | 0.88 kg |
| Energy Efficiency Index EEI = B1 | | | | |
| EC 18 TCD LB112K 240/50 050A110 IDC | 22179254 | 5 pieces strapped | 1,600 pieces | 0.54 kg |
| EC 18 B502K 240/50 090A191 | 22148765 | 5 pieces strapped | 1,000 pieces | 0.85 kg |
| EC 18 TCD LB502K 240/50 050A151 | 22148766 | 5 pieces strapped | 1,400 pieces | 0.50 kg |
| EC 21 B502K 240/50 050A151 | 22148767 | 5 pieces strapped | 1,400 pieces | 0.50 kg |
| EC 36 B502K 240/50 090A191 | 22148771 | 5 pieces strapped | 1,000 pieces | 0.85 kg |
| EC 70 B502K 240/50 100A191D | 22148772 | 5 pieces strapped | 1,000 pieces | 0.97 kg |

Specific technical data

| Lamp wattage | Lamp type | Rated lamp current | Type | Article number | Length L | Hole spacing D | Core length KL | Δ T | λ | Compensation, parallel (cos φ > 0.9) | |
|---|-----------|--------------------|------------------|----------------|----------|----------------|----------------|------|------|--------------------------------------|---------------|
| | | | | | | | | | | Capacitor ± 10 % 250 V | Mains current |
| Energy Efficiency Index EEI = B2 | | | | | | | | | | | |
| 1 x 15 W | T8 | 0.310 A | EC 15 C502K | 22149234 | 151 mm | 110 – 144 mm | 50 mm | 55 K | 0.31 | 4.0 μF | 0.09 A |
| 2 x 18 W | T8 | 0.370 A | EC 2x18 OC502K | 22175106 | 151 mm | 110 – 144 mm | 40 mm | 60 K | 0.51 | 4.0 μF | 0.20 A |
| 1 x 18 W | T8 | 0.370 A | EC 18 C502K | 22175070 | 151 mm | 110 – 144 mm | 50 mm | 55 K | 0.32 | 4.0 μF | 0.12 A |
| 1 x 18 W | T8 | 0.370 A | EC 18 LC502K | 22148708 | 151 mm | 110 – 144 mm | 54 mm | 50 K | 0.30 | 4.0 μF | 0.12 A |
| 1 x 23 W | T8 | 0.290 A | EC 18 LC502K | 22148708 | 151 mm | 110 – 144 mm | 54 mm | 35 K | 0.40 | 3.0 μF | 0.12 A |
| 1 x 26 W | TC-D | 0.325 A | EC 18 LC502K | 22148708 | 151 mm | 110 – 144 mm | 54 mm | 40 K | 0.42 | 3.5 μF | 0.13 A |
| 1 x 28 W | TC-DD | 0.320 A | EC 18 LC502K | 22148708 | 151 mm | 110 – 144 mm | 54 mm | 40 K | 0.46 | 3.5 μF | 0.14 A |
| 1 x 18 W | TC-L | 0.370 A | EC 18 LC502K | 22148708 | 151 mm | 110 – 144 mm | 54 mm | 50 K | 0.30 | 4.0 μF | 0.11 A |
| 1 x 24 W | TC-L | 0.345 A | EC 18 LC502K | 22148708 | 151 mm | 110 – 144 mm | 54 mm | 45 K | 0.39 | 3.5 μF | 0.13 A |
| 1 x 22 W | T9c | 0.400 A | EC 30 C502K | 22149241 | 151 mm | 110 – 144 mm | 50 mm | 75 K | 0.32 | 4.0 μF | 0.16 A |
| 2 x 15 W | T8 | 0.310 A | EC 30 C502K | 22149241 | 151 mm | 110 – 144 mm | 50 mm | 55 K | 0.52 | 4.0 μF | 0.17 A |
| 1 x 36 W | T8 | 0.430 A | EC 36 C502K | 22175071 | 151 mm | 110 – 144 mm | 50 mm | 55 K | 0.46 | 4.0 μF | 0.22 A |
| 2 x 18 W | T8 | 0.370 A | EC 36 C502K | 22175071 | 151 mm | 110 – 144 mm | 50 mm | 55 K | 0.48 | 4.0 μF | 0.22 A |
| 1 x 40 W | T12-U | 0.430 A | EC 36 LC502K | 22148709 | 151 mm | 110 – 144 mm | 54 mm | 55 K | 0.49 | 4.0 μF | 0.22 A |
| 1 x 40 W | T12c | 0.415 A | EC 36 LC502K | 22148709 | 151 mm | 110 – 144 mm | 54 mm | 50 K | 0.49 | 4.0 μF | 0.23 A |
| 1 x 36 W | T8 | 0.430 A | EC 36 LC502K | 22148709 | 151 mm | 110 – 144 mm | 54 mm | 55 K | 0.44 | 4.0 μF | 0.22 A |
| 1 x 38 W | T8 | 0.430 A | EC 36 LC502K | 22148709 | 151 mm | 110 – 144 mm | 54 mm | 55 K | 0.47 | 4.0 μF | 0.22 A |
| 1 x 38 W | TC-DD | 0.430 A | EC 36 LC502K | 22148709 | 151 mm | 110 – 144 mm | 54 mm | 55 K | 0.46 | 4.0 μF | 0.22 A |
| 1 x 36 W | TC-L | 0.430 A | EC 36 LC502K | 22148709 | 151 mm | 110 – 144 mm | 54 mm | 55 K | 0.44 | 4.0 μF | 0.22 A |
| 2 x 18 W | T8 | 0.370 A | EC 36 LC502K | 22148709 | 151 mm | 110 – 144 mm | 54 mm | 50 K | 0.49 | 4.0 μF | 0.10 A |
| 2 x 18 W | TC-L | 0.370 A | EC 36 LC502K | 22148709 | 151 mm | 110 – 144 mm | 54 mm | 50 K | 0.49 | 4.0 μF | 0.21 A |
| 1 x 65 W | T12-U | 0.670 A | EC 58 C502K | 22149260 | 191 mm | 150 – 184 mm | 90 mm | 50 K | 0.46 | 6.0 μF | 0.30 A |
| 1 x 58 W | T8 | 0.670 A | EC 58 C502K | 22149260 | 191 mm | 150 – 184 mm | 90 mm | 50 K | 0.46 | 6.0 μF | 0.30 A |
| 1 x 75 W | T12 | 0.670 A | EC 70 C502K | 22148773 | 191 mm | 150 – 184 mm | 90 mm | 45 K | 0.51 | 6.0 μF | 0.38 A |
| 1 x 70 W | T8 | 0.700 A | EC 70 C502K | 22148773 | 191 mm | 150 – 184 mm | 90 mm | 50 K | 0.55 | 6.0 μF | 0.38 A |
| Energy Efficiency Index EEI = B1 | | | | | | | | | | | |
| 1 x 18 W | TC-D | 0.220 A | EC 18 TCD LB112K | 22179254 | 110 mm | 97 – 105 mm | 50 mm | 35 K | 0.41 | 3.5 μF | 0.14 A |
| 1 x 18 W | T8 | 0.370 A | EC 18 B502K | 22148765 | 191 mm | 150 – 184 mm | 90 mm | 30 K | 0.29 | 4.0 μF | 0.12 A |
| 1 x 23 W | T8 | 0.290 A | EC 18 B502K | 22148765 | 191 mm | 150 – 184 mm | 90 mm | 25 K | 0.38 | 3.0 μF | 0.13 A |
| 1 x 26 W | TC-D | 0.325 A | EC 18 B502K | 22148765 | 191 mm | 150 – 184 mm | 90 mm | 30 K | 0.40 | 3.5 μF | 0.13 A |
| 1 x 28 W | TC-DD | 0.320 A | EC 18 B502K | 22148765 | 191 mm | 150 – 184 mm | 90 mm | 25 K | 0.44 | 3.5 μF | 0.14 A |
| 1 x 18 W | TC-L | 0.370 A | EC 18 B502K | 22148765 | 191 mm | 150 – 184 mm | 90 mm | 30 K | 0.29 | 4.0 μF | 0.10 A |
| 1 x 24 W | TC-L | 0.345 A | EC 18 B502K | 22148765 | 191 mm | 150 – 184 mm | 90 mm | 30 K | 0.38 | 3.5 μF | 0.13 A |
| 1 x 18 W | TC-D | 0.220 A | EC 18 TCD LB502K | 22148766 | 151 mm | 110 – 144 mm | 50 mm | 35 K | 0.41 | 2.0 μF | 0.08 A |
| 1 x 21 W | TC-DD | 0.260 A | EC 21 B502K | 22148767 | 151 mm | 110 – 144 mm | 50 mm | 35 K | 0.41 | 3.0 μF | 0.11 A |
| 1 x 40 W | T12-U | 0.430 A | EC 36 B502K | 22148771 | 191 mm | 150 – 184 mm | 90 mm | 35 K | 0.45 | 4.0 μF | 0.22 A |
| 1 x 40 W | T12c | 0.415 A | EC 36 B502K | 22148771 | 191 mm | 150 – 184 mm | 90 mm | 30 K | 0.46 | 4.0 μF | 0.22 A |
| 1 x 36 W | T8 | 0.430 A | EC 36 B502K | 22148771 | 191 mm | 150 – 184 mm | 90 mm | 35 K | 0.41 | 4.0 μF | 0.20 A |
| 1 x 38 W | T8 | 0.430 A | EC 36 B502K | 22148771 | 191 mm | 150 – 184 mm | 90 mm | 35 K | 0.44 | 4.0 μF | 0.21 A |
| 1 x 38 W | TC-DD | 0.430 A | EC 36 B502K | 22148771 | 191 mm | 150 – 184 mm | 90 mm | 30 K | 0.42 | 4.0 μF | 0.19 A |
| 1 x 36 W | TC-L | 0.430 A | EC 36 B502K | 22148771 | 191 mm | 150 – 184 mm | 90 mm | 35 K | 0.42 | 4.0 μF | 0.18 A |
| 2 x 18 W | T8 | 0.370 A | EC 36 B502K | 22148771 | 191 mm | 150 – 184 mm | 90 mm | 30 K | 0.45 | 4.0 μF | 0.19 A |
| 1 x 75 W | T12 | 0.670 A | EC 70 B502K | 22148772 | 191 mm | 150 – 184 mm | 100 mm | 45 K | 0.56 | 6.0 μF | 0.38 A |
| 1 x 70 W | T8 | 0.700 A | EC 70 B502K | 22148772 | 191 mm | 150 – 184 mm | 100 mm | 45 K | 0.50 | 6.0 μF | 0.36 A |

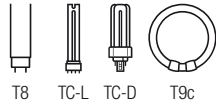

ETAWATT 18 – 58 W
230 V 50 Hz

Product description

- Magnetic chokes for fluorescent lamps
 - Nominal life time 100,000 hours at $t_w = 130\text{ °C}$
- For product data sheet go to www.tridonic.com, or available on request

Technical data

| | |
|--------------------------------|---|
| Rated voltage | 230 V, 50 Hz |
| Max. winding temperature t_w | 130 °C |
| Push-in terminal | 0.5 – 1.5 mm ² for rigid wires |



Standards, page 5

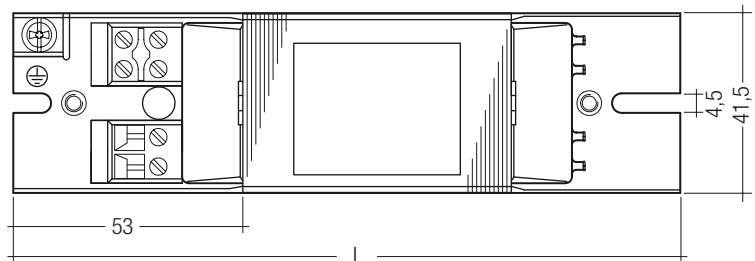

Ordering data

| Type | Article number | Packaging, carton | Packaging, pallet | Weight per piece |
|---|----------------|-------------------|-------------------|------------------|
| Energy Efficiency Index EEI = B2 | | | | |
| ETAWATT 18 NG301 IND 230V/50 | 86454136 | 20 pieces | 800 pieces | 0.76 kg |
| ETAWATT 30 NG301 IND 230V/50 | 86454142 | 20 pieces | 800 pieces | 0.76 kg |
| ETAWATT 36 NG301 IND 230V/50 | 86454158 | 20 pieces | 800 pieces | 0.75 kg |
| ETAWATT 58 NG301 IND 230V/50 | 86454161 | 20 pieces | 800 pieces | 1.20 kg |

Specific technical data

| Lamp wattage | Lamp type | Rated lamp current | Type | Article number | Length L | Hole spacing D | ΔT | λ | Compensation, parallel ($\cos \varphi > 0.9$) | |
|---|-----------|--------------------|------------------|----------------|----------|----------------|------------|-----------|---|---------------|
| | | | | | | | | | Capacitor $\pm 10\%$ 250 V | Mains current |
| Energy Efficiency Index EEI = B2 | | | | | | | | | | |
| 1 x 18 W | T8 | 0.370 A | ETAWATT 18 NG301 | 86454136 | 170 mm | 150 – 159 mm | 45 K | 0.32 | 4.2 μF | 0.13 A |
| 1 x 18 W | TC-L | 0.370 A | ETAWATT 18 NG301 | 86454136 | 170 mm | 150 – 159 mm | 45 K | 0.31 | 4.2 μF | 0.13 A |
| 1 x 23 W | T8 | 0.290 A | ETAWATT 18 NG301 | 86454136 | 170 mm | 150 – 159 mm | 45 K | 0.42 | 4.2 μF | 0.13 A |
| 1 x 24 W | TC-L | 0.345 A | ETAWATT 18 NG301 | 86454136 | 170 mm | 150 – 159 mm | 45 K | 0.40 | 4.2 μF | 0.13 A |
| 1 x 26 W | TC-D | 0.325 A | ETAWATT 18 NG301 | 86454136 | 170 mm | 150 – 159 mm | 45 K | 0.43 | 4.2 μF | 0.13 A |
| 1 x 30 W | T8 | 0.365 A | ETAWATT 30 NG301 | 86454142 | 170 mm | 150 – 159 mm | 50 K | 0.48 | 3.6 μF | 0.18 A |
| 1 x 22 W | T9c | 0.400 A | ETAWATT 30 NG301 | 86454142 | 170 mm | 150 – 159 mm | 50 K | 0.33 | 3.6 μF | 0.18 A |
| 2 x 15 W | T8 | 0.310 A | ETAWATT 30 NG301 | 86454142 | 170 mm | 150 – 159 mm | 50 K | 0.52 | 3.6 μF | 0.18 A |
| 1 x 36 W | T8 | 0.430 A | ETAWATT 36 NG301 | 86454158 | 170 mm | 150 – 159 mm | 50 K | 0.47 | 4.3 μF | 0.21 A |
| 1 x 36 W | TC-L | 0.430 A | ETAWATT 36 NG301 | 86454158 | 170 mm | 150 – 159 mm | 50 K | 0.45 | 4.3 μF | 0.21 A |
| 1 x 38 W | T8 | 0.430 A | ETAWATT 36 NG301 | 86454158 | 170 mm | 150 – 159 mm | 50 K | 0.48 | 4.3 μF | 0.21 A |
| 2 x 18 W | T8 | 0.370 A | ETAWATT 36 NG301 | 86454158 | 170 mm | 150 – 159 mm | 50 K | 0.49 | 4.3 μF | 0.21 A |
| 1 x 58 W | T8 | 0.670 A | ETAWATT 58 NG301 | 86454161 | 235 mm | 220 – 229 mm | 50 K | 0.48 | 4.3 μF | 0.33 A |

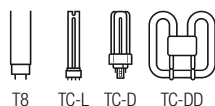

EC 18 – 28 W

230 V 50 Hz

Product description

- Magnetic chokes for fluorescent lamps
 - Encapsulated for protection class II applications
 - Double insulated
 - Irreversible thermal cutout
- For product data sheet go to www.tridonic.com, or available on request

Technical data

| | |
|-----------------------------------|---|
| Rated voltage | 230 V, 50 Hz |
| Max. winding temperature tw | 130 °C |
| Push-in terminal | 0.5 – 1.5 mm ² for rigid wires |
| Trigger value, thermal protection | 150 °C |

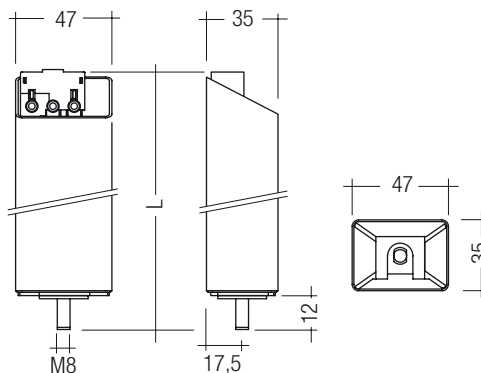

Standards, page 5

Ordering data

| Type | Article number | Packaging, carton | Packaging, pallet | Weight per piece |
|---|----------------|-------------------|-------------------|------------------|
| Energy Efficiency Index EEI = B2 | | | | |
| EC 18 LC201B 230/50 ZIMP113 | 22149220 | 26 pieces | 936 pieces | 0.55 kg |

Specific technical data

| Lamp wattage | Lamp type | Rated lamp current | Type | Article number | Length L | Δ T | λ | Compensation, parallel (cos φ > 0.9) | |
|---|-----------|--------------------|--------------|----------------|----------|------|------|--------------------------------------|---------------|
| | | | | | | | | Capacitor ± 10 % 250 V | Mains current |
| Energy Efficiency Index EEI = B2 | | | | | | | | | |
| 1 x 18 W | T8 | 0.370 A | EC 18 LC201B | 22149220 | 113 mm | 65 K | 0.32 | 4.5 μF | 0.11 A |
| 1 x 23 W | T8 | 0.290 A | EC 18 LC201B | 22149220 | 113 mm | 50 K | 0.42 | 3.5 μF | 0.14 A |
| 1 x 26 W | TC-D | 0.325 A | EC 18 LC201B | 22149220 | 113 mm | 55 K | 0.43 | 3.5 μF | 0.14 A |
| 1 x 28 W | TC-DD | 0.320 A | EC 18 LC201B | 22149220 | 113 mm | 55 K | 0.48 | 3.5 μF | 0.15 A |
| 1 x 18 W | TC-L | 0.370 A | EC 18 LC201B | 22149220 | 113 mm | 65 K | 0.31 | 4.5 μF | 0.11 A |
| 1 x 24 W | TC-L | 0.345 A | EC 18 LC201B | 22149220 | 113 mm | 60 K | 0.40 | 4.0 μF | 0.14 A |

Linear lamps

Single lamp uncompensated

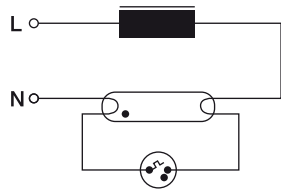

Single lamp series compensated

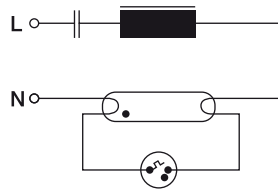

Single lamp parallel compensated

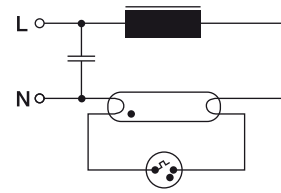

Twin series lamps uncompensated

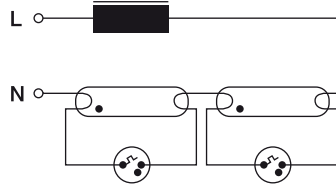

Twin series lamps series compensated

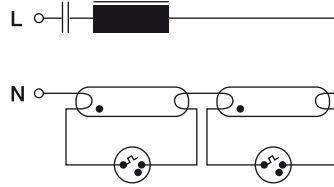

Twin lamp lead / lag

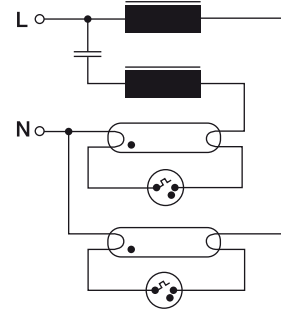

Twin series lamps parallel compensated

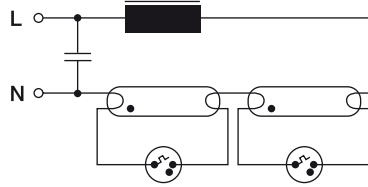

Twin lamp parallel compensated; 2 x value of parallel capacitor (single circuit), 2x18 W T8 = 8 µF (250 V)

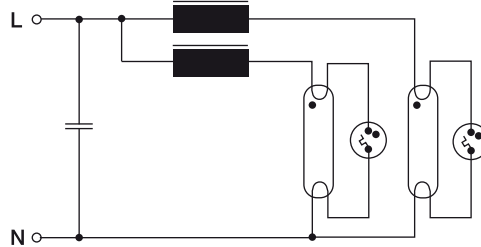

Compact lamps

Single 2-pin lamp uncompensated

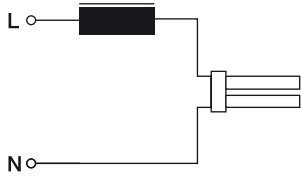

Single 2-pin lamp parallel compensated

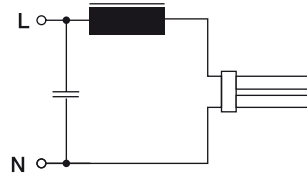

Twin series 2-pin lamps uncompensated

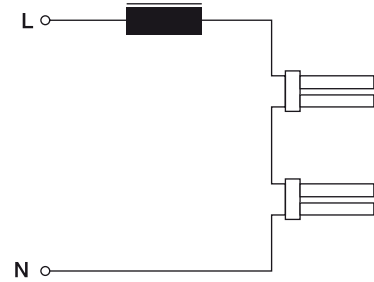

Twin series 2-pin lamps parallel compensated

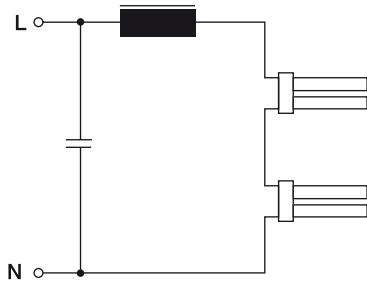

Single 4-pin lamp uncompensated

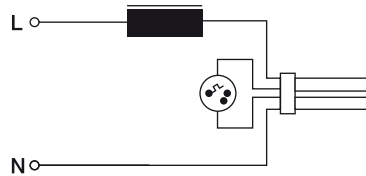

Single 4-pin lamp parallel compensated

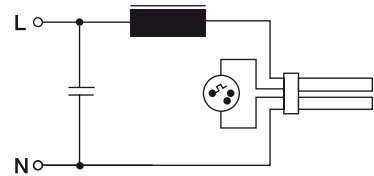

Single 4-pin lamp series compensated

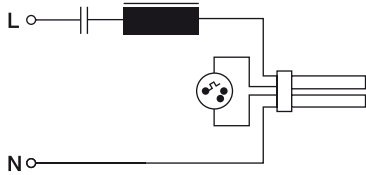

Twin series 4-pin lamps uncompensated

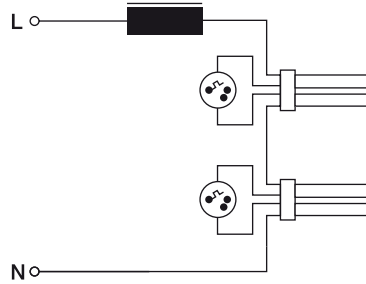

Twin series 4-pin lamps parallel compensated

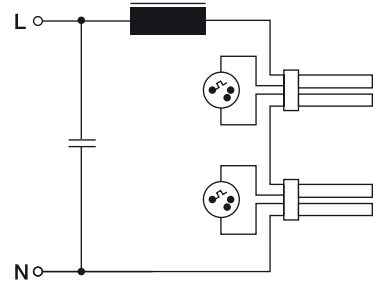

Twin series 4-pin lamps series compensated

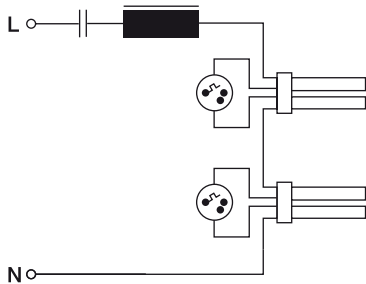

Twin 4-pin lamps lead / lag

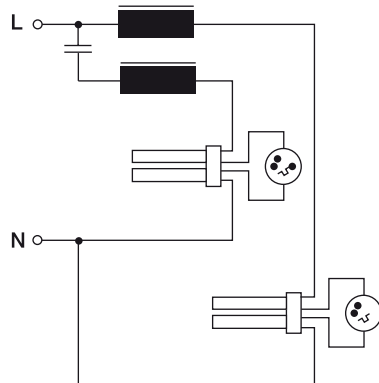

Twin 4-pin lamps parallel compensated

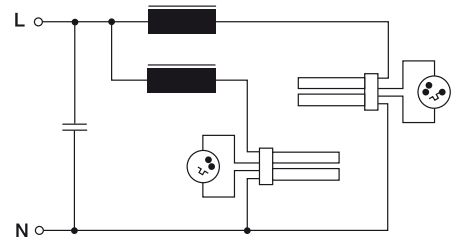

Go to www.tridonic.com to find your personal contact at Tridonic.

Further information and ordering data:



FLASH
customer magazine
Order no. 89100886
11/12



Data sheets available
at www.tridonic.com,
“Technical data” menu



Certificates at
www.tridonic.com,
“Technical data” menu



Effective 09/13
Subject to change without notice.