

Nexus[®] 1252

For Smart Grid and Substation Automation

Accu-Measure™ Technology



**Auto-Calibrating
Metrology**

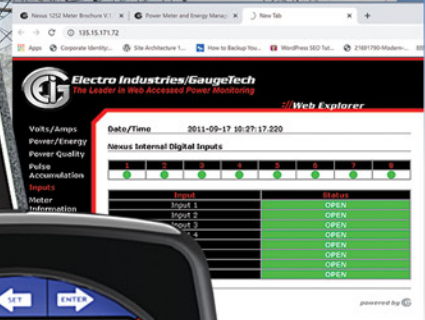

**XML Web Server
with Email Alarms**

Advanced Performance Smart Power Meter and Substation Data Acquisition Node

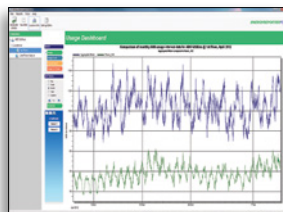

0.06% Billing Grade
Power Metering

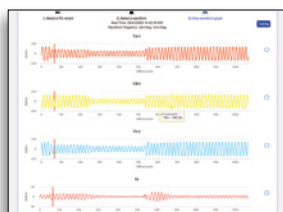

Performance
Quality Monitoring

- Billing Grade Revenue Meter - 0.06%
- Precision Auto-calibrating Metrology
- RTU with I/O & Control
- Power Quality Recorder
- Onboard Ethernet Connectivity
- DNP3 Level 2 Plus
- Extensive Communication Capabilities
- Smart Grid and Automation Solutions

Advanced Smart Grid Solutions

Smart Grid and automated data collection solutions are the backbone of a modern power distribution system. From the residential metering point to the sophisticated transmission substation automation solutions, accurate and reliable data collection is critical to success. The advanced monitoring features of the Nexus® 1252 meter provide the total picture of power usage and power quality for any metered point within a power distribution network, allowing power related decisions to be made quickly and effectively. With EIG's exclusive Total Web Solutions, you can monitor your Nexus® 1252 meter anytime and from anywhere via the Internet and receive critical alarms via email when action is required.

Technology Designed for Utilities, Industrial Users and Critical Power Applications

For Energy Providers

(Utilities, Municipals, ESPs, Independents, etc.)

- Improve Substation Automation Solutions
- Increase Power Distribution Reliability
- Record Faults/Time Protective Equipment
- Monitor Reliability of Breakers and Relays
- Shed or Shift Loads Quickly
- Identify and Manage Peak Demand
- Heighten Response Time to PQ Events
- Enhance Levels of Communication and Data Transmission
- Provide Real Time Data on the Web

For Energy Consumers

(Industrial, Commercial, Government, etc.)

- Real Time PQ Monitoring and Analysis
- Efficiently Control/Manage Energy Consumption
- Reduce Costs/Conserve Energy
- Improve Operational Efficiency
- Increase Productivity/Reduce Downtime
- Optimize Loads/Extend Equipment Life
- Identify and Respond to PQ Events Quickly
- Avoid High Utility Penalties for Exceeding Usage
- View Energy Usage

Obtain High-End Power Quality and Accurate Billing Measurements

High-performance energy usage and power quality meter data is always available at your fingertips with the Nexus® 1252 meter. It provides you with the necessary power system assessment information in real time. The Nexus® 1252 meter provides advanced power disturbance recording, including EN 50160/IEC 61000-4-15 Flicker Analysis and detailed PQ reporting. Use the meter's precision accuracy for primary metering or submetering, or for checking on an installed utility meter.

Expandable I/O and Trending Customize the Nexus® 1252 Meter for Every Application



The Nexus® 1252 meter offers virtually unlimited I/O capability in conjunction with all metering functions. Expandable I/O enables the meter to be used for all metering and data-gathering applications. The meter's modular plug-in design allows you to add analog and digital I/O to meet your specific application. With this advanced I/O capability, you can use the Nexus® 1252 meter to replace RTUs and PLCs for energy management and substation automation solutions. Using this meter, you can monitor the reliability of system apparatus, such as transformers, circuit breakers, or other critical equipment.

Accu-Measure™ Technology

Multi-Part Approach to Precision in Accuracy - The Nexus® 1252 unit is the first meter of its kind to utilize EIG's patented Accu-measure™ technology. Accu-measure™ technology is a technique based on a multi-part approach that allows a field-mounted metering device to achieve laboratory grade accuracy.

Dual High-Powered 16-Bit A/D Converters - Dual 16-bit A/D converters provide supreme sampling accuracy and resolution.

Dual Internal References Stable to 5 PPM - The unit auto-adjusts to dual internal references stable to 5 parts per million. These references ensure that the monitoring equipment maintains its calibration.

Auto-Calibration with Temperature Compensation - The meter uses an auto-calibration technique that re-calibrates the unit when the temperature changes more than 5 degrees Celsius, monitoring for accuracy over temperature.

Precision Accuracy Specifications - With Accu-measure™ technology, this unit meets ANSI C12.20 0.2 Accuracy Class specifications for watt-hour accuracy.

Revenue Metering Features

Transformer and Line Loss Compensation - The unit compensates for transformer and line losses. Power reading compensation is conducted for both iron and copper losses.

CT and PT Compensation - The Nexus® unit compensates for errors in current transformers and potential transformers.

- Voltage Compensation
- Multipoint Current Compensation
- Multipoint Phase Angle Compensation
- Better than 0.01% Resolution

Time of Use Capability - The Nexus® 1252 meter offers comprehensive time of use capability. Standard features include:

- Bidirectional Consumption and Demand Quantities
- 20 Year Calendar
- 4 Seasons/Year
- 12 Holidays/Year
- 4 TOU Schedules/Season
- Prior Month, Prior Season Storage
- Present Month, Present Season Storage

Max/Min Integration - The unit offers timestamped max and min values for almost all measured readings. A timestamp is associated with each max and min value. Any integration period is allowed. The default period is 15 minutes. KW readings are integrated using:

- Block Window
- Thermal Window
- Rolling Window
- Predictive Window

Coincidental Readings - When logging max watt readings, the coincidental VARs at the time of the max are also recorded. You can determine the number of capacitors needed, identify peak inefficiencies, and resolve many other issues.

Password Protection Prevents Unauthorized Tampering - Two 10-character, alphanumeric passwords protect the unit from unauthorized tampering. The first level password allows a user to view readings, but not to change them. The second level password allows the user to re-program the unit.

Load Aggregation/Universal Metering - Using the status inputs, the meter can count pulses and aggregate different loads, providing a total picture of the load and its component parts. The pulse inputs can be used to accumulate and aggregate all other utility values, such as water and gas.

- 8 Pulse Inputs Standard
- 4 Aggregators
- 32 Additional External Pulse Inputs

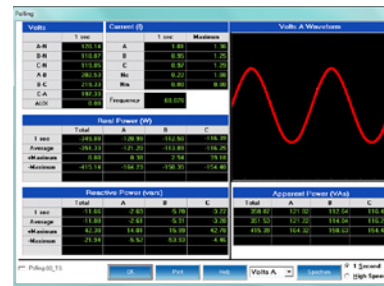

Real Time Readings and Waveform Display

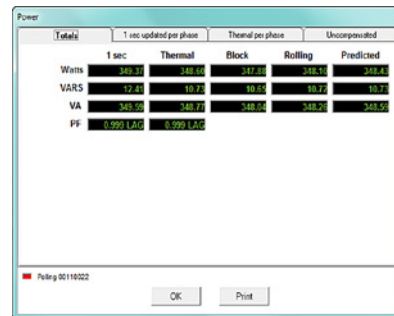

Four Quadrant Energy and Demand

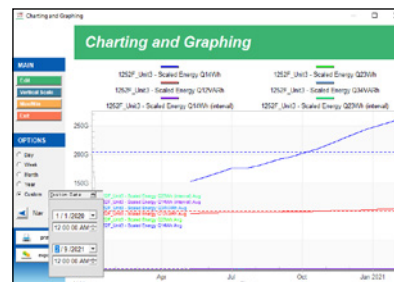

Historical Trends for Any Parameter

Detailed Power Quality Recording

16-Bit Waveform Event and Fault Recorder - The unit records up to 512 samples per cycle for a power quality event. Voltage and current are recorded with pre and post event analysis. Fault recording offers 8x full scale capture capability on current. All voltage and current readings are recorded using a 16-bit A/D converter, providing precise waveform resolution. Both hardware and software triggers are available to activate a waveform recording, which can be used for power quality surveys, fault analysis, breaker timing, etc.

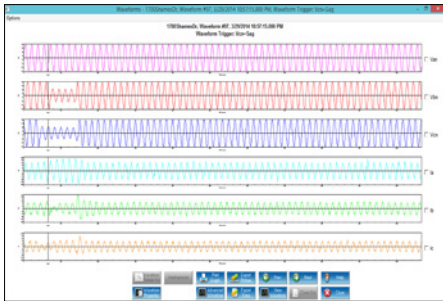

High Resolution Waveform Recording

Measure and Record Harmonic Magnitudes to the 255th Order - The unit measures harmonic magnitudes up to the 255th order for each voltage and current channel. Real time harmonic magnitudes are resolved to the 128th order. THD and K-Factor are also calculated. This high-performance harmonic analysis allows users to conduct power quality analysis at the high end of the harmonic spectrum.

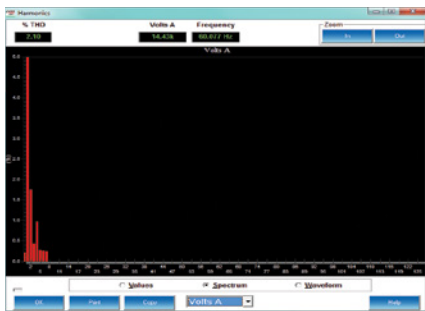

128th Order Real Time Harmonic Spectrum

Subcycle Transient Recorder - The unit records subcycle transients on voltage and current readings. It monitors switching noise from capacitors, static transfer switches, SCRs and many other “power quality harmful” devices. Transients are often the cause of intermittent and expensive periods of downtime. Without the Nexus® 1252 meter, solving these problems is often impossible.

Status Input Triggers - The unit records the waveform at the time of the status change.

The input change and waveform recording are timestamped to a 1 ms resolution. Up to 8 inputs can be plotted on the waveform. This enables a user to time the reliability of relays and circuit breakers.

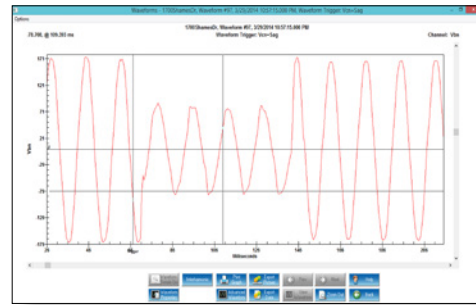

128th Order Real Time Harmonic Spectrum

Additional Inputs - The Nexus® 1252 meter offers inputs for Neutral to Ground voltage measurements. This allows you to analyze rising ground potential, which often damages electrical equipment. The unit also calculates and measures the neutral current.

Independent ITIC/CBEMA Log Plotting - The Nexus® 1252 meter stores an independent ITIC/CBEMA log for magnitude and duration of voltage events. With this log, the user can quickly view total surges, total sags, and average duration, without having to retrieve waveform information.

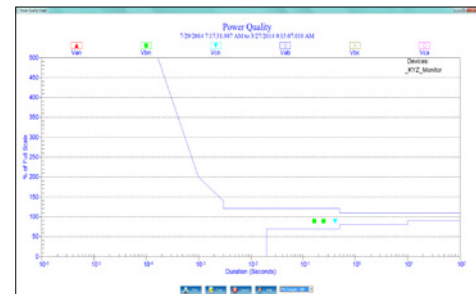

ITIC/CBEMA Plotting Showing Damaging Power Quality Events

Phasor Analysis - The monitor reads a phase angle analysis between the voltage and current channels, allowing for efficiency and system integrity analysis.

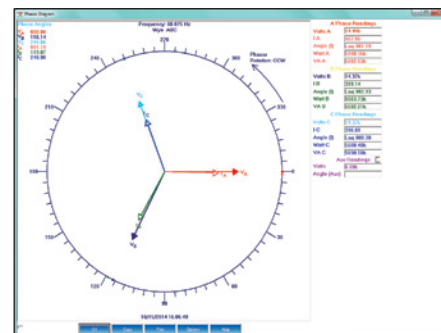

Phasor Analysis

Advanced Reporting and Analysis

EN 50160/IEC 61000-4-15 Flicker and Compliance Monitoring (V2 Only)

It is important to maintain a source of high-quality power to ensure efficient operations. One source of disturbance that can have very negative effects is Flicker, which consists of low frequency to intermittent line disturbances on the power line. Aside from effects on equipment, disturbances of this type can have negative effects on people. An example is the flickering of light sources that can affect humans in different ways, depending on the severity. The Nexus® 1252 meter with V-Switch™ key 2 measures to the Flicker requirements of EN 50160/IEC 61000-4-15 and includes:

- Flicker Evaluation-Instantaneous readings suitable for online monitoring; Short Term Readings (PST - 10 Min) - logging and monitoring; Long Term Readings (PLT - 4 hour) - logging and monitoring
- Polling Pinst, Pst, Pst Max, Pst Min, Plt, Plt Max, Plt Min values
- Log Viewer - view graphed values Pst and Plt for Va, Vb, and Vc or displayed values, including Max and Min.

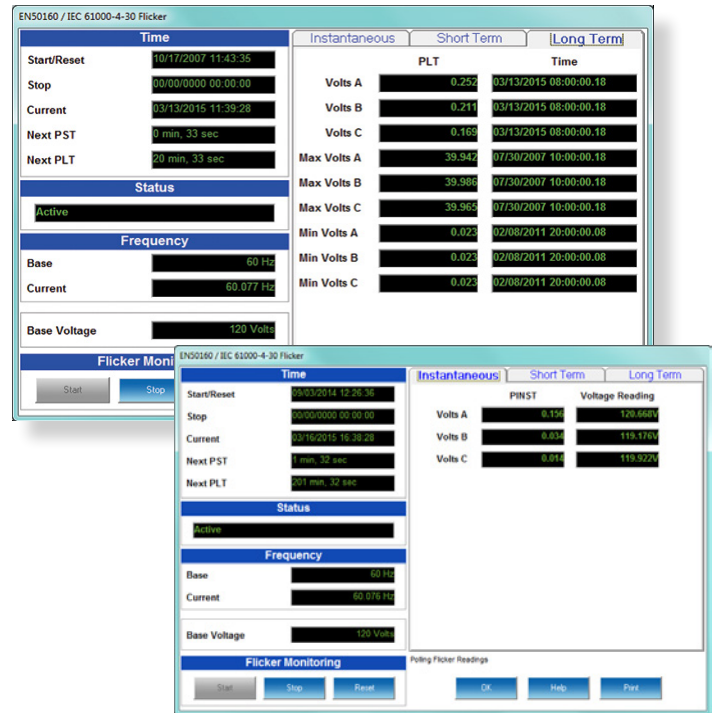

Note that this meter is accurate for evaluation, but not for compliance.

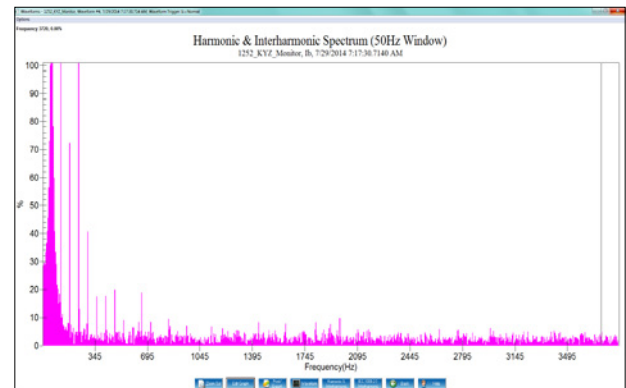
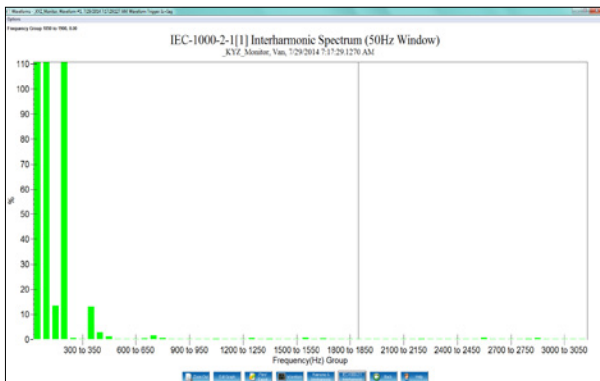

Substation Voltage and Frequency Recording

The Nexus® 1252 meter provides users with the ability to view interharmonics, the discrete frequencies that lie between the harmonics of the power frequency voltage and current. Frequencies can now be observed which are not an integer multiple of the fundamental; and which can appear as discrete frequencies or as a wide-band spectrum.

The user can set a starting point anywhere in the waveform, assuming that there are enough sample points available after the starting point. If there are not enough points in this waveform capture, the software will check the next waveform record stored in the database. If it is contiguous, additional points up to 200 ms will be retrieved for analysis.



Total Web Solutions - Providing Metering Data Integration with the Web

Total Web Solutions is an advanced Ethernet communication architecture that allows you to custom design webpages, display metering data and host your meter power information web site directly on a Nexus® meter.

The Nexus® meter hosts the web data without any need for dedicated server software, ActiveX Controls or Java Applets. The meter does the data collection, the formatting, and the page hosting. Additionally, this solution is very Information Technology department friendly because it creates almost no network traffic and provides all formatted data through an HTTP interface without resident client software.

Advanced Features Include:

- Fully Customizable Webpage Development
- Direct Webpage Hosting with Live Readings
- Multiple Meter Hosting on One Page
- Read Direct from Meters (No Server Software Needed)
- No ActiveX Controls or Java Downloads
- IT Dept. Friendly: Works through Firewalls; Low-Cost/High Functionality
- Instant Alarm Emails – Directly from the Meter

WebExplorer (Directly Host Metering Data)

EIG's WebExplorer provides you with direct access to all power data through a web browser without needing to download ActiveX Controls or Java Applets. Because it is a standard HTML webpage to an IT department, it works directly through corporate firewalls. WebExplorer is fully programmable so you can customize your own SCADA quality webpages, graphics, and configurations.

- Easily Incorporated into Any Existing Web Applications
- Fully Programmable Webpage Generator
- Brings in Direct XML Links, Customizing Many Meters onto One Page
- Quick Page Upload Time
- Easily Passes through Firewalls
- No ActiveX Controls or Java Applets Downloaded to Client



WebExplorer

WebXML

WebReacher

WebXML

Creates Real Time Data in XML Format. WebXML allows the Nexus® meter to gather data from the Nexus® host or through other meters and put the data directly into an XML format. This allows you to share data through the web with multiple applications and to create custom webpages, using WebExplorer. WebXML technology is easy to configure and extremely flexible. With WebXML, your data is instantly available to a host of software applications, including standard web browsers, spreadsheet applications, presentation software, and word processing applications, among others.

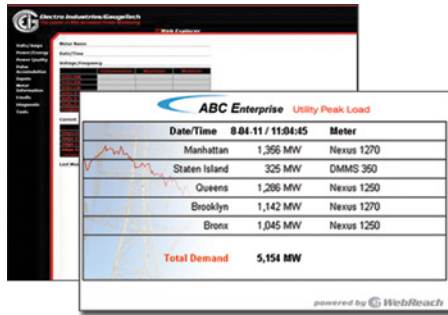

- XML Support
- Automatically Process and Present Data in Readable Format
- Add Scale Factors, Multipliers or Any Other Desired HTML Capability
- Display Data from Host Meter and/or Any Other Meter Using Modbus RTU or TCP/IP (WebReacher)
- Customized Programming for Data Collection
- Easily Viewed by Different Applications
- Modbus Data Concentrator

WebReacher

With EIG's exclusive WebReacher technology, you can now access remote meters around the world, retrieve data and consolidate it onto one webpage or web site without any separate software SCADA package or client-side ActiveX Controls or Java Applets.

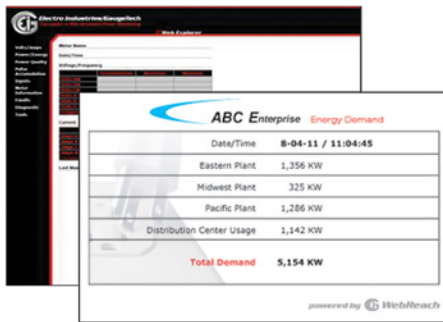

- No Additional Application Software Costs
- No Server System Required
- No Complex Integration
- No ActiveX Controls or Java Applets on Client
- No Costly Point Charges (Up to 32 Devices)

WebAlarm

EIG's WebAlarm sends real time email alerts via the Internet to up to 9 recipients simultaneously for any combination of event notifications. With WebAlarm, you can easily program the type of email format for the alert: either short format for text messages or long format that will provide detailed alarm conditions for any devices with full email support (computers, PDAs, cell phones).

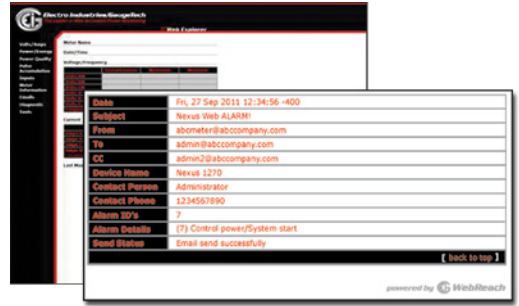

- Real Time Alerts
- Simultaneous Emails to Multiple Recipients
- Update Users on Virtually Any Abnormality
- Uses Standard SMTP – Just Assign Email Addresses
- Shows the Last 10 Emails on Web Site for Later Investigation

WebMod (Open Architecture 3rd Party Integration)

The 10/100BaseT design allows the unit to speak with 12 simultaneous sockets of Modbus TCP/IP. Once the card is placed inside the Nexus® meter, Port 2 becomes a gateway enabling other Modbus based IED equipment to be interfaced to the network LAN, thus allowing multiple simultaneous requests for data. EIG's WebMod features Modbus TCP/IP open protocol that can be easily integrated with most other software or hardware. And with the built-in Modbus data concentrator, you can poll up to 8 devices or 512 unique polling items from any device that can speak Modbus RTU or Modbus TCP/IP protocols.



WebDNP

Using this feature, you can gain access to the meter speaking native DNP over Ethernet. This allows the unit to open an exclusive network socket for DNP3. Using this unique technology, all other meter web features are available simultaneously. Even with DNP3 over Ethernet, you still have access to multiple Modbus sockets, email alarms and many other communication features.

Multiple Programmable Memory Logs

The meter utilizes two separate logs of historical information. In addition to all power parameters, the historical logs allow users to trend data from Electro Industries' remote I/O devices. Furthermore, circuit breaker pressure, transformer temperature or any other analog or digital parameter can be monitored. You can use the information gained to perform power analysis and to learn when preventive maintenance of critical equipment should be performed.

Primary Historical Trending Log File — Log 1 - Log any measured parameter from either the main unit or any of the option modules. Either 8, 16, 32 or 64 values can be logged per programmable interval.

Secondary Historical Trending Log File — Log 2 - This log can be set up as an additional historical interval log or as an exclusive energy log. Either 8, 16, 32 or 64 values can be logged per interval.

Out of Limit Log - The unit offers an independent out of limit log. This allows a user to download out of limit information to obtain a sequence of events for any occurrence. Utilizing the 1 ms clock resolution, the logs can be combined with different metered points throughout a distribution system to provide an accurate system-wide depiction of a power disturbance.

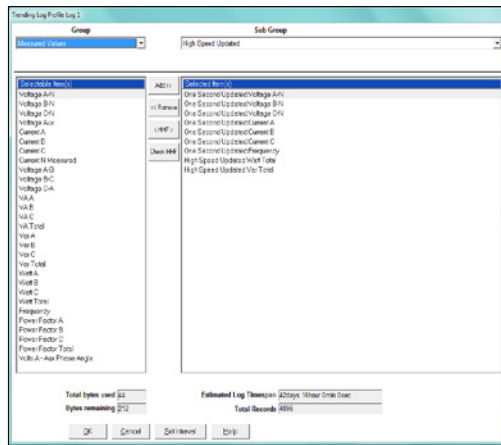

Easily Select Parameters for Historical Logs

Event-triggered Waveform Recording Log - The meter records waveforms with a resolution of up to 512 samples per cycle. The unit records the waveform when a value goes out of limit and when the value returns to normal. All information is time stamped to the nearest millisecond. The 8 onboard high-speed inputs can be tied to the waveform recording. You can record when the breaker tripped as compared to when the relay activated.

This is very useful for fault and breaker integrity analysis. The unit can be programmed to take more than one recording every time an event occurs. Thousands of cycles can be recorded per event.

ITIC/CBEMA Log - The meter stores a separate ITIC/CBEMA log that records magnitude and duration of voltage clock resolution. The logs can be combined with different metered points throughout a distribution system to provide an accurate system-wide depiction of a power disturbance.

Relay Output Log - The unit records when a relay output from the external I/O is activated, timestamps the event and provides a reason for the relay's changed status.

Input Status Log - The unit records input status changes with a timestamp and duration.

Uploadable Flash Memory - The Nexus® 1252 meter utilizes uploadable flash memory technology on all processors and DSPs located in the unit. This ensures that the unit can be upgraded without removing it from service.

Samples Per Cycle	Number of Cycles Recorded Per Screen*	Max. Number of Cycles Recorded Per Event	Number of Channels
16	8 Pre / 56 Post Event Screen	6080	7
32	4 Pre / 28 Post Event Screen	3040	7
64	2 Pre / 12 Post Event Screen	1520	7
128	1 Pre / 7 Post Event Screen	760	7
256	1 Pre / 3 Post Event Screen	760	3
512	1 Pre / 3 Post Event Screen	760	1

Note: * Calculations at 60 Hz.

Available Logs	Storage Alloc.	Records
Historical 1	1664 kB	555 Days
Historical 2	400 kB	133 Days
Out of Limit	96 kB	512 Events
ITIC/CBEMA/PQ	64 kB	512 Events
Relay Output	48 kB	256 Events
Input Status	48 kB	1024 Events
Waveform Events	1568 kB	95 Events
Flicker	160 kB	5120 Days
System Events	16 kB	1024 Events
TOU Recording	128 kB	20 Years

Note: Historical Log 1 is calculated recording 8 values every 15 minutes. Historical Log 2 is calculated storing all integrated hour readings every 15 minutes. Every log reading is recorded with exact timestamps.

Use the Meter As an RTU

Electro Industries offers multiple Analog and Digital I/O modules that mount externally to the Nexus® meter. The unit supports up to 4 I/O modules using internal power. An additional power supply extends I/O capability. The meter's Master port eliminates the need for RTUs in many substation applications. The meter can poll different I/O devices, log data and send data to a master station via Modbus or DNP3 protocol. This I/O functionality is available in the Nexus® 1252 meter at much lower cost than traditional substation RTUs.

Relay Control — Programmable Logical Protection and Control

The Nexus® 1252 meter provides advanced logic and control on programmable limit settings. The 7,000 values that the meter measures can have limits and logic set to trigger operations. This feature allows a user to configure the meter to be used as a control device for many applications such as:

- Capacitor Control
- Load Shedding
- Automatic Transfer Schemes
- Transformer Monitoring & Control
- Redundant Protection (Not designed for Primary Over-Current Protection)
- Many Other Control Functions

Graphical Programming Interface for Relaying and Control

EIG's unique ElectroLogic™ relay control structure allows users to develop up to 3 tiers of logic control based on limits and status conditions. All data is displayed in a graphical tree structure. The user can set logical descriptors, such as:

- AND/NAND/XAND Gates
- OR/NOR/XOR Gates
- Hysteresis/NHysteresis Control

Using the graphical array, each tier can be configured to the desired logical scheme, enabling the meter to address complex control requirements. The meter's ElectroLogic™ relay control can be extended for a virtually unlimited number of relay outputs. Simply add additional I/O modules. Response time is typically less than 200 ms per I/O module, extendible to multiple seconds.

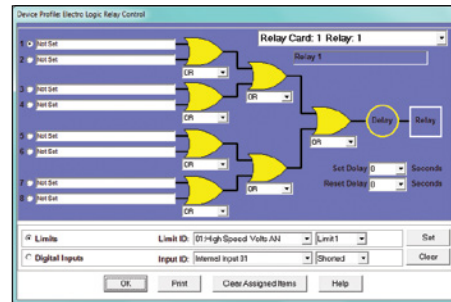

Graphical 3 Tier Programming Interface

Superior Construction and Isolation

This unit is a rugged, durable device. It provides considerable protection and isolation from damaging outside forces.

Case Construction - The unit is mounted in a shielded metal case. It is resistant to contamination from harmful dust, sand, or other matter. All screws and hardware are stainless steel.

Power Supply - The power supply offers both MOV protection and active line filtering to reduce any damaging occurrences to the supply.

Voltage Inputs - The voltage inputs are optically isolated. Issues such as noisy grounds, switching noise, SWC, or any similar problems pose no threat to the Nexus® 1252 meter.

Current Inputs - The current inputs are direct shorts. They offer a stud input U-Bolt design with an internal toroidal sensor. Since this is a 0.15" thick solid brass U-Bolt without solder or weld joints, the unit's current input and surge withstand capability is significant.

Communication Ports - All communication ports are isolated from the main unit and additionally isolated from each other. This avoids dangerous ground loops.

I/O Modules - Each I/O module is isolated from the main unit and from other I/O modules. No signal entering an I/O module can damage any other part of the Nexus® 1252 meter.

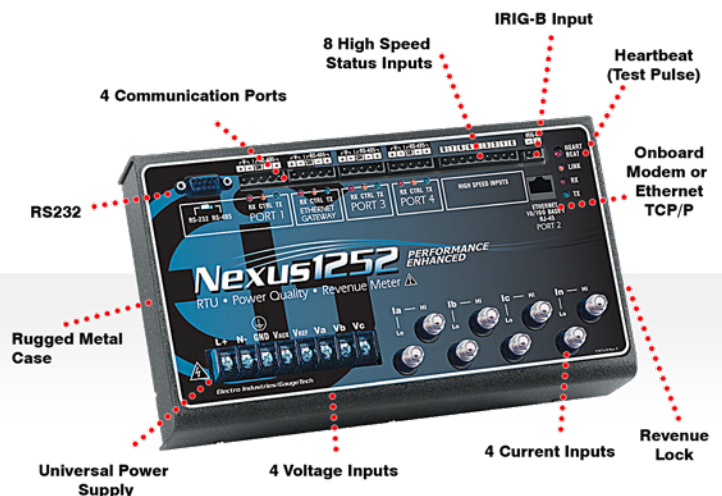

Robust Communication for Every Option

4 Isolated High-speed Communication Ports - The meter offers 4 built-in identical communication ports. Each port speaks any desired protocol. Standard protocols include Modbus RTU/ASCII and DNP3 Level 2. Logs and Waveform event data can be retrieved in Modbus ASCII/RTU. Port 3 and Port 4 can be used as a Modbus master for I/O modules.

- Voltage Readings
- Synchronizing Schemes

The Vaux channel can be used to get the frequency, magnitude, and phase angle on both sides of a switch or between generator and bus voltage.

Industry Leading DNP3 Level 2 Plus - The Nexus® 1252 meter provides the industry's most advanced DNP3 protocol implementation. The meter complies with all DNP3 Level 1 and Level 2 certification requirements PLUS a host of additional features including:

Additional Capabilities

8 Built-in Digital High-speed Status Inputs - These inputs automatically sense whether the circuit is externally wetted. If externally wetted, the input will accept up to 300 V DC. If internally wetted, the unit supplies the needed voltage for the desired control application.

High-speed Transducer Outputs for Control Purposes - The meter offers 200 ms updates for all instantaneous readings. The unit can be a high-speed control transducer for power generation, transmission line synchronization and any other synchronizing and control scheme.

Vaux Input - The unit has a high-speed Vaux input. This input can be used for multiple purposes:

- Up to 136 measurements (64 Binary Inputs, 8 Binary Counters, 64 Analog Inputs) can be mapped to DNP static points in the customizable DNP point map.
- Up to 16 relays and 8 resets can be controlled through DNP.
- Report-by-exception processing (DNP Events) deadbands can be set on a per-point basis.
- 250 events consisting of combinations of four events (Binary Input Change, Frozen Counter, Counter Change, Analog Change).
- Freeze Commands: Freeze, Freeze/No-Ack, Freeze with Time, Freeze with Time/No-Ack.
- Freeze with Time command enables the Nexus® meter to have internal time driven Frozen Counter and Frozen Counter Event data. When the Nexus® meter receives the Time and Interval, the data will be created.
- Third party certification is available.

- Neutral to Ground

Multiple Communication Paths (One Example Shown Below)

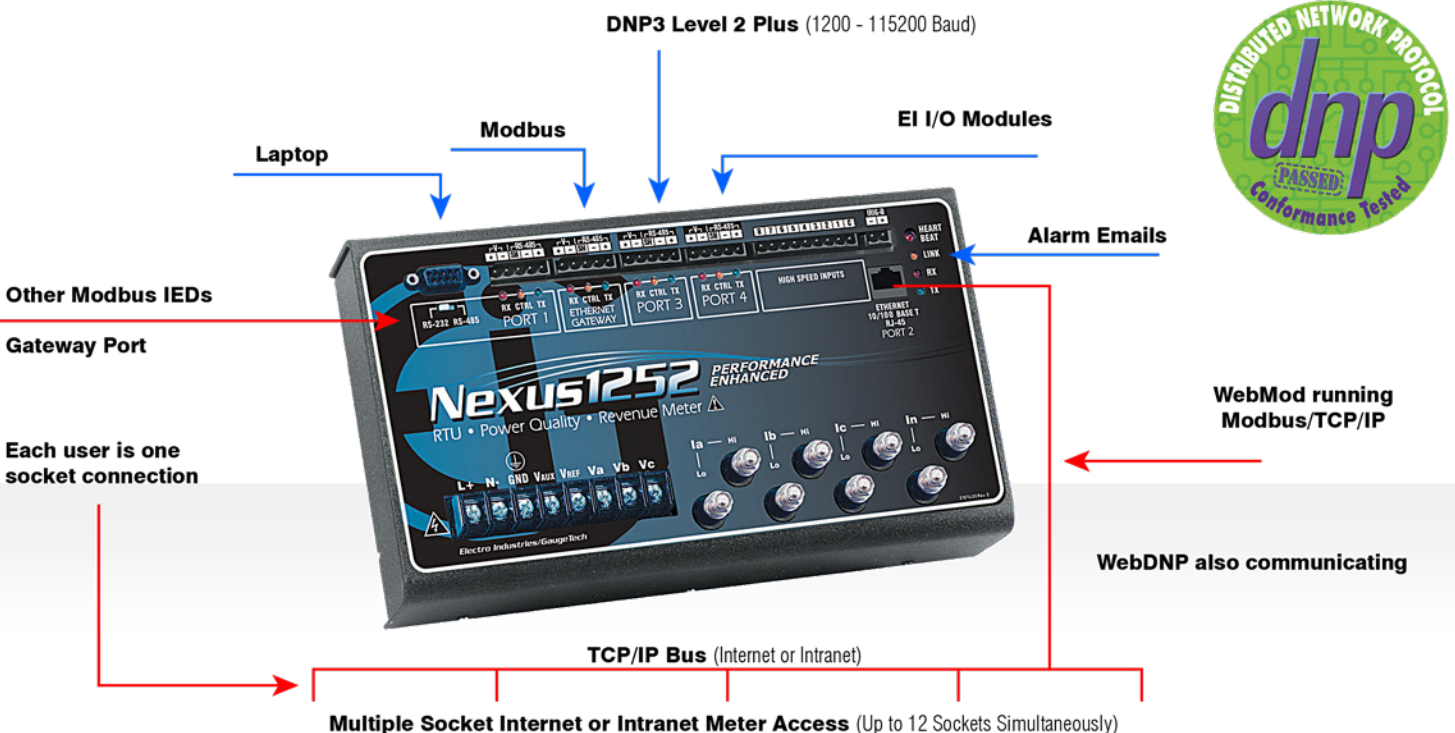

Improve Reliability with Substation System Equipment Monitoring

The Nexus® 1252 meter allows you to monitor the health and status of critical substation equipment, such as transformers and circuit breakers. This ensures the user that the electrical distribution infrastructure is sound and reliable.



Circuit Breaker Monitoring

- Record Faults
- Monitor Operations of Relays and Breakers
- Record Fault Events with Millisecond Timing
- Count Operations
- Calculate Accumulated I²T on Contacts



Transformer Monitoring

- Measure Voltage, Current, Power and PF
- Limit on VA Ratings
- Data Trend and/or Alarm Transformer Temperature
- Log Ambient Temperature
- Monitor TAP Position



P40N+ Series Multifunction LED Displays

- **P40N+:** Multifunction LED Display. Also used as Master volt display for single function remote displays. USB Front panel port for data downloads and real time polling.
- **P41N+:** Ampere Display Slave
- **P43N+:** Watt/VAR/PF Display Slave



Multifunction/Master



Ampere Slave



Watt/VAR/PF Slave

Analog Transducer Signal Outputs

- **1MAON4:** 4 Analog Outputs, 0 ± 1 mA, self-powered, scalable
- **1MAON8:** 8 Analog Outputs, 0 ± 1 mA, self-powered, scalable
- **20MAON4:** 4 Analog Outputs, 4–20 mA, self-powered, scalable
- **20MAON8:** 8 Analog Outputs, 4–20 mA, self-powered, scalable
- **Wiring:** Common Mode
- **Accuracy:** 0.1% of Full Scale
- **Calibration:** Self-Calibrating
- **Scaling:** Programmable
- **Ordering Specifics:** Up to 4 modules can be used.

Analog Transducer Signal Inputs

- **8AI1:** 8 Analog Inputs, 0 ± 1 mA

- **8AI2:** 8 Analog Inputs, 0 ± 20 mA
- **8AI3:** 8 Analog Inputs, 0 ± 5 V DC
- **8AI4:** 8 Analog Inputs, 0 ± 10 V DC
- **Wiring:** Common Mode
- **Accuracy:** 0.25% of Full Scale
- **Scaling:** Programmable
- **Ordering Specifics:** Up to 4 modules can be used.

Digital Dry Contact Relay Outputs

- **4RO1:** 4 Relay Outputs, 5 A, 125 V AC/DC, Form C
- **Ordering Specifics:** Up to 4 modules can be used.

Digital Solid State Pulse Outputs

- **4PO1:** 4 Solid State Pulse Outputs, Form A or C KYZ Pulses
- **Maximum Pulse Speed:** 20 pulses per second.
- **Ordering Specifics:** Up to 4 modules can be used.

Digital Inputs

- **8DI1:** 8 Digital Status Inputs Wet/Dry Auto-Detect Up to 300 Volts DC

Additional I/O Accessories

- **PSIO:** Power supply for up to 4 additional I/O modules. This accessory may be needed when using 3 or more displays and/or modules.
- **MBIO:** Mounting bracket for I/O modules.



Stackable I/O Module Design

Wiring Diagrams

Refer to the Nexus® 1252 manual for additional wiring diagrams.

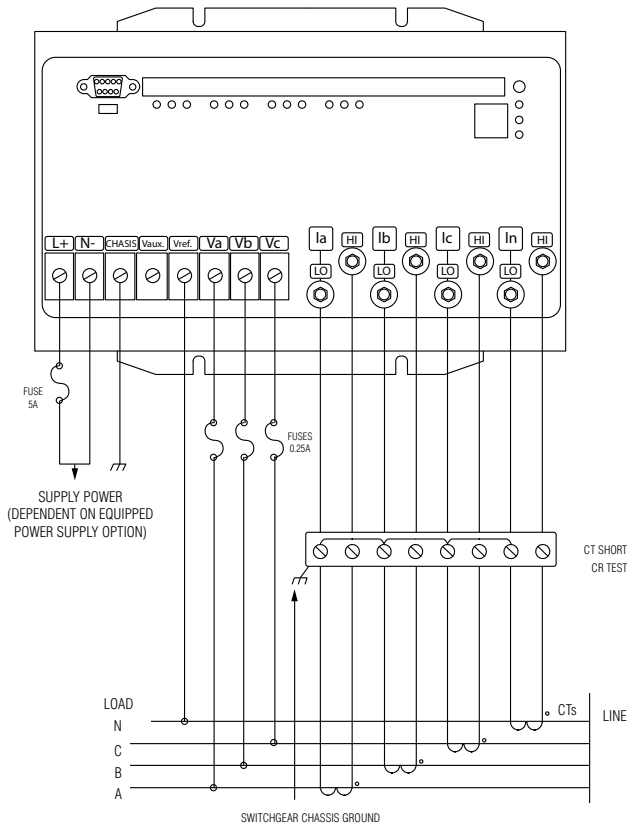

4 WIRE WYE: 3 ELEMENT DIRECT VOLTAGE

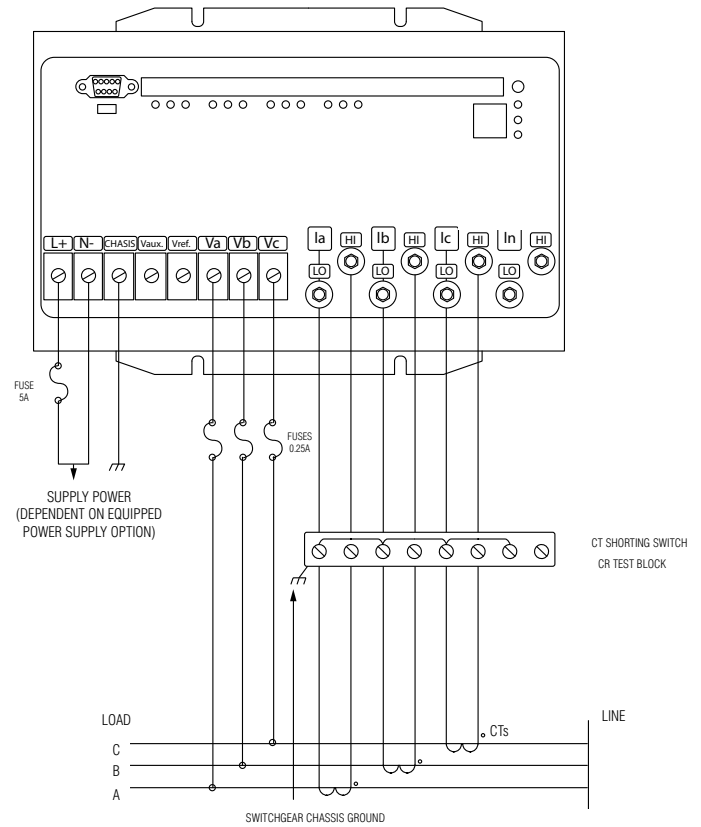

3 WIRE: 3 ELEMENT DIRECT DELTA

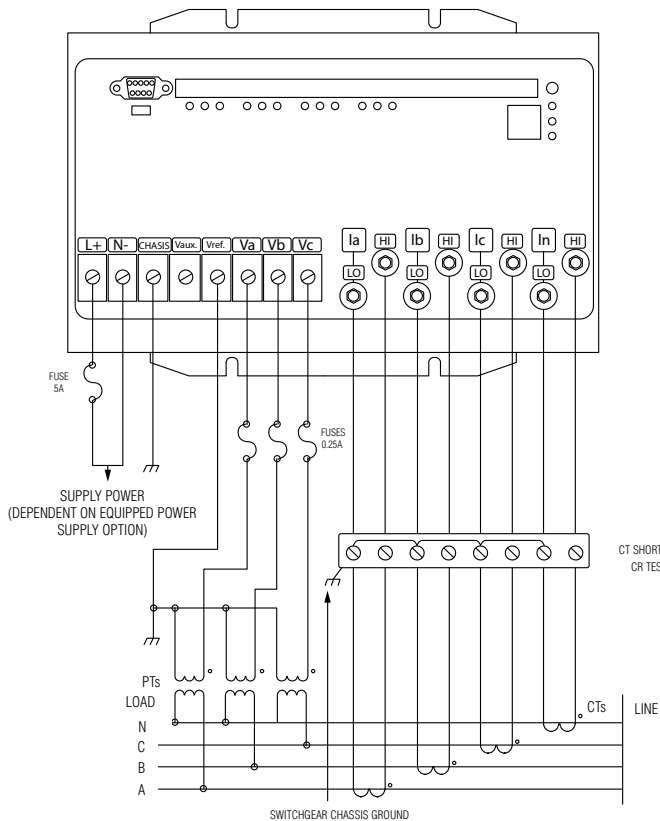

4 WIRE WYE: 3 ELEMENT CONNECTION USING 3 PTs and 4 CTs

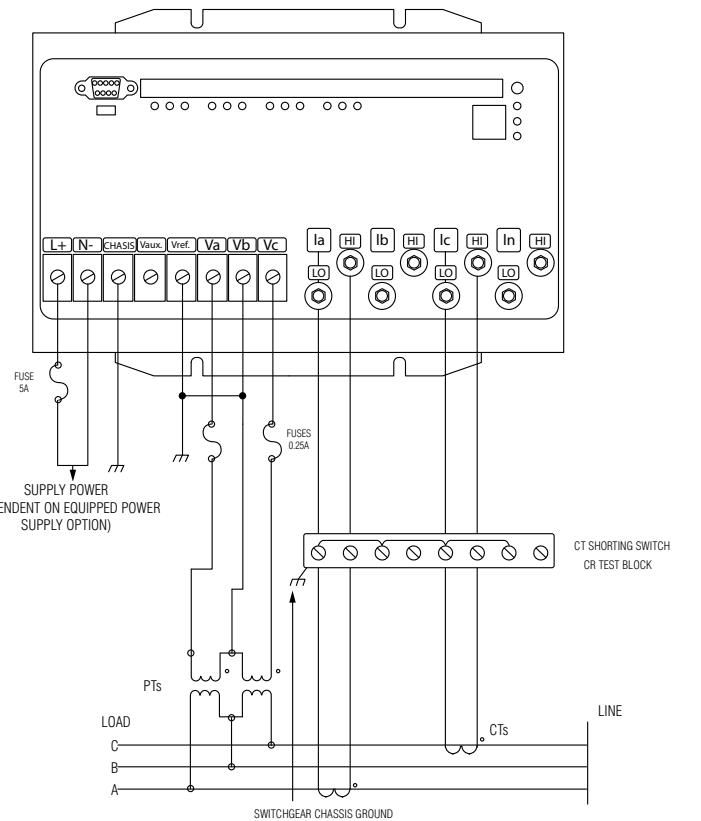

3 WIRE: 3 ELEMENT OPEN DELTA

Mounting Information

Contact Electro Industries for different mounting options.

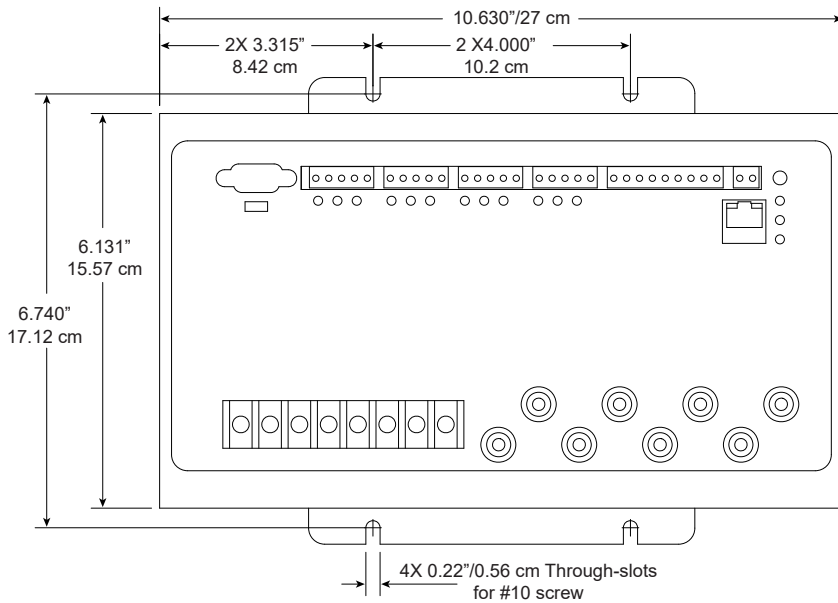

**Nexus® Monitor
Front View**

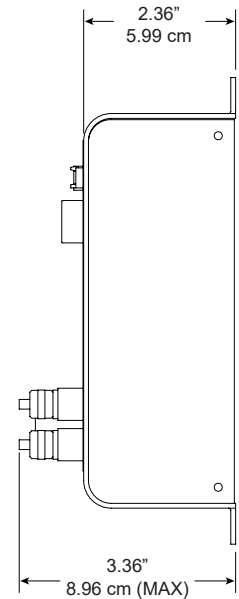

**Nexus® Monitor
Side View**

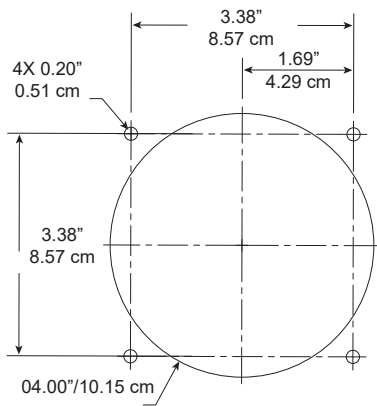

**Nexus® P40N+ Display
Cutout Pattern**

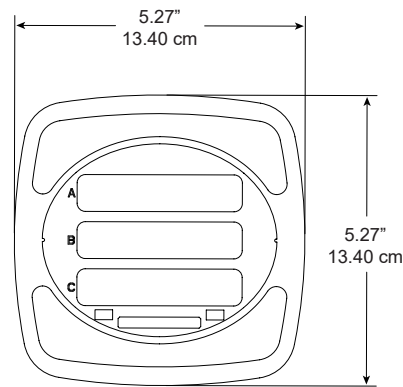

**Nexus® P40N+ Display
Front View**

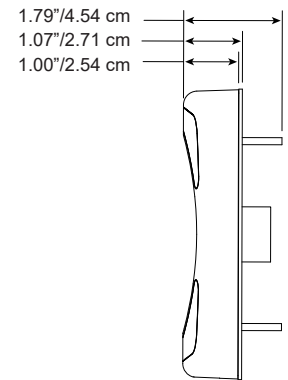

**Nexus® P40N+ Display
Side View**

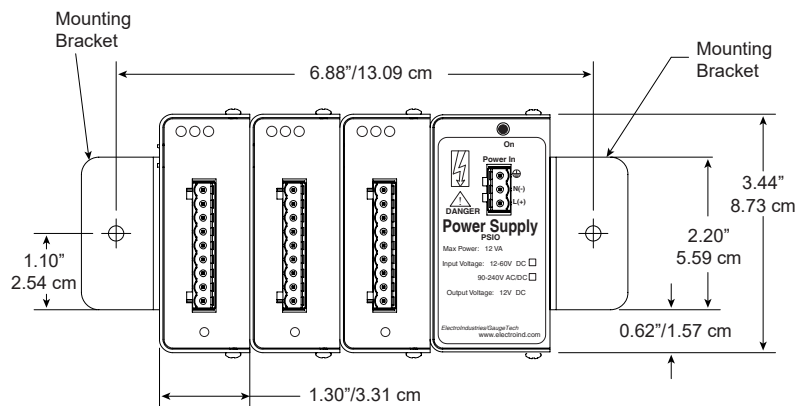

Nexus® I/O Modules Front View

Specifications

Voltage Inputs (4: A, B, C, Ref.) Range:

- 150 V L-N, 300 V L-L (Suffix-120) (Used with PTs for Extended Range)
- 300 V L-N, 600 V L-L (Suffix-G)

Current Inputs (4: A, B, C, N)

- Class 10 - 5 A nominal
- Class 2 - 1 A nominal (special order)
- Class 0.5 - 0.25 nominal (special order)
- CT ratio is programmable to any value
- Fault Current recording to 60 A peak secondary based on 5 A full scale

Over Current Withstand Capability (@23 °C)

- 2x Current Class, continuous
- 100 A for 10 Seconds
- 300 A for 3 Seconds
- 500 A for 1 Second
- Continuous Withstand Rating: 20 A

Burden

- Voltage Inputs: 0.05 VA@120 V rms
- Current Inputs: 0.002 VA@5 A rms

Isolation

- All inputs and outputs are isolated to 2500 V DC. All Com Ports are additionally isolated from each other.

Temperature Rating

- Operating Temperature: (-40 to +70) °C
- Humidity: Up to 95% Non-condensing

Sensing Method

- Up to 512 Samples per Cycle (Programmable)
- 16-Bit A/D Resolution – Dual Converters
- Accu-measure™ Auto-Calibration Technology
- True RMS

Accuracy Rating

- This unit complies with ANSI C12.20 and IEC 62053-22 accuracy requirements.

Update Time

- 200 ms — High Speed Readings
- 1 second — Revenue Accurate Readings

Control Power Requirements

- 120 V AC/DC (-20%) - 230 V AC (+20%) (Suffix -D2)
- 24 V DC (-20%) - 48 V DC (+20%) (Suffix -D)
- Burden: 20 VA Max

Frequency Range

- Fundamental (20 to 65) Hz

Communication Format

- Programmable parity and stop bits
- Communication protocols: Modbus TCP/IP, ASCII/RTU and DNP3 Level 2 Plus
- 4 Communication ports, 2 slave ports, 2 selectable master/slave ports
- All ports use 2-wire RS485 communication; Port 1 is RS232 or RS485 selectable
- INP200 - Total Web Solutions - 10/100BaseT Ethernet

Construction

- Housed in a metal case. All screws are stainless steel.

Shipping

- Total shipping weight: approx. 5 lbs. (2.2 kgs)
- Shipping container dimensions: 14" x10" x6" (35.6 cm x 25.4 cm x 15.2 cm)
- Displays and I/O modules ship in separate containers.

Compliance

- ANSI C12.20 0.2 CL
- CE (IEC 61000-6-2 & IEC 61000-6-4 & IEC 61326-1)*
 - EN/IEC 61000-4-2 Level 3 (Electrostatic Discharge)*
 - EN/IEC 61000-4-3 (Radiated EM Immunity)*
 - EN/IEC 61000-4-4 (Electrical Fast Transient)*
 - EN/IEC 61000-4-5 (Surge Immunity)*
 - EN 61000-4-6 (Conducted Immunity)*
 - EN 61000-4-8 (Magnetic Immunity)*
 - EN 61000-4-11 (Voltage Variations Immunity)*
 - IEC/CISPR11, Class A (Radiated Emissions)*
 - IEC/CISPR22 (Conducted Emissions)*
- UL 61010*

*Third party lab tested

Measurement Accuracy (% of Reading)

Parameter	200 Millisecond	1 Second	Display Resolution
Voltage (L-N)	0.1%	0.05%	7
Voltage (L-L)	0.1%	0.05%	7
Current	0.1%	0.025%	7
Frequency	0.03 Hz	0.01 Hz	7
W @ PF = 1	0.1%	0.06 %	3
KW @ PF = 0.5	0.1%	0.1%	1
VAR	0.1%	0.08%	7
Power Factor	0.1%	0.08%	7
Harmonics	N/A	0.2%	7
Watt Hour	N/A	0.08%	3
VA hour	N/A	0.08%	1
VAR hour	N/A	0.08%	7

Note: Readings are in percent of reading where applicable (a more accurate standard), not in percent of Full Scale (a less accurate standard).

To Order a Nexus® 1252 Meter:

1. Fill out the options desired in the order chart below. List accessories separately.
2. Specify display type and number.
3. Specify desired I/O modules and mounting bracket(s).
4. Specify the CommunicatorPQA® application.
5. If you provide CT and PT ratios and wiring, EIG will program the units at the factory.

Example:

Options: Nexus 1252-A-120-D2-60Hz-V2-INP200-P40N+

Accessories: 1mAoN4-8A1-MBIO-COMPQA5P1Y

This equates to a Nexus® 1252 Advanced meter with an operating voltage of (0-150) V L-N and (0-300) V L-L, a 90-276 Volts AC/DC power supply, 60 Hz frequency, V-Switch™ Key 2, an internal 10/100BaseT Ethernet port, a multifunction LED display, a 0-1 mA output module, an analog input module, an I/O module mounting bracket, and a one year license for Communicator-PQA® software.

Ordering Information - All fields must be filled in to create a valid part number.									
	Nexus® Base	Memory Options	Operation Voltage	Control Power	Frequency Range	V-Switch™ Pack	Internal Expansion Port Options	Revenue Seal	
Option Numbers:	-	-	-	-	-	-	-	-	-
Example:	Nexus® 1252	A	120	D	60 Hz	V1	INP200	X	
	Nexus® 1252 (Meter/Transducer)	A Advanced	120 (0-150) V L-N (0-300) V L-L	D (18-60) V DC Power Supply	60 Hz	V1 Standard Nexus® 1252 Meter	X No Expansion Port	X	
			G 300 V L-N 600 V L-L	D2 (90-276) V AC/DC Power Supply	50 Hz	V2 Advanced Flicker Measurement	INP200 Total Web Solutions 10/100BaseT Ethernet	ICR Revenue Seal	
Accessory Options									
Displays									
P40N+	Multi-Function LED Display/Master				PSIO	Power Supply for Additional I/O Modules			
P41N+	Amp Display Meter				MBIO	I/O Mounting Bracket (must be ordered with purchase of I/O module)			
P43N+	Watt/VAR/PF Display Slave								
I/O Modules					Software				
1mAON4	4 Analog Outputs, 0±1 mA				COMPQA5P1Y	CommunicatorPQA® 5 software to Windows Single Computer License (One year)			
1mAON8	8 Analog Outputs, 0±1 mA								
20mAON4	4 Analog Outputs, 4–20 mA								
20mAON8	8 Analog Outputs, 4–20 mA								
8AI1	8 Analog Inputs, 0±1 mA								
8AI2	8 Analog Inputs, 0±20 mA								
8AI3	8 Analog Inputs, 0±5 V DC								
8AI4	8 Analog Inputs, 0±10 V DC								
4RO1	4 Relay Outputs								
4PO1	4 Solid State Pulse Outputs								
8DI1	8 Digital Status Inputs								