

100% EXTENSION

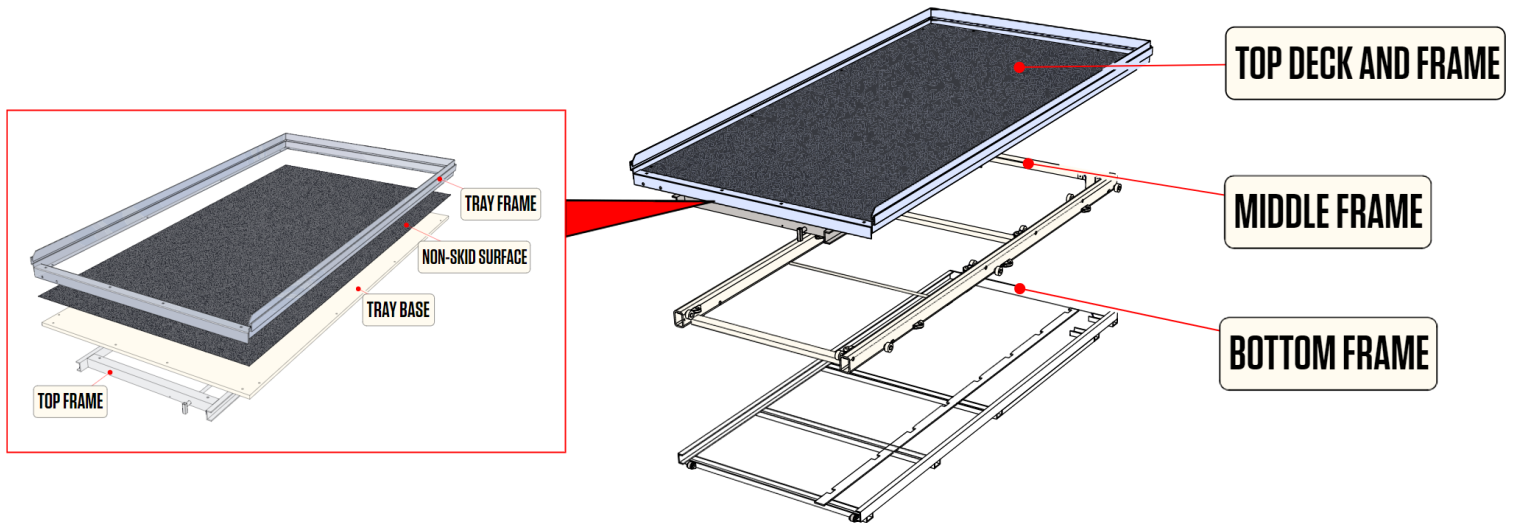

100% EXTENSION

CG1000XL/CG1500XL/2200XL Owner's Manual



TOOLS NEEDED:

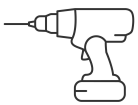

drill



tape measure

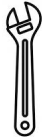

crescent wrench



5/16" drill bit



1/2" drill bit



knife

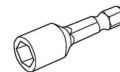

1/2" socket



ratchet or impact driver



CONTENTS:

(you may have extra parts - lucky you!)

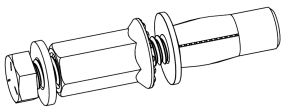

plusnut tool
(assembled on 2.5" bolt with washer and plusnut)

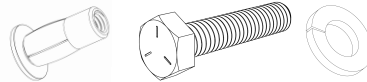

mounting hardware:
plusnuts
1.5" bolts
washers

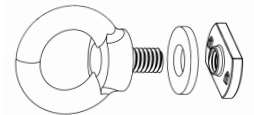

tie-down eye bolts:
eye bolts
nylon washers
weld nuts

Warning: It is the responsibility of the installer to ensure the DECKED CG1000XL/CG1500XL/CG2200XL unit is securely fastened to a base which will provide safe and reliable operation. **DO NOT INSTALL ON DROP-IN PLASTIC BEDLINERS, RUBBER FLOOR MATS OR COMPOSITE BEDS.** The many variations in application and placement of a sliding platform present specific issues to consider for safety and utility. The following recommendations are intended to be general in nature and provide important safety information for the installer to consider during installation.

FOLLOW US:



@DECKEDUSA | #DECKEDUSA

NOTE: NOT RECOMMENDED FOR COMPOSITE BEDS or INSTALLATION ONTO A DECKED DRAWER SYSTEM

PLEASE SEE ALTERNATE INSTALL FOR THE FORD F-150 LIGHTNING AND F-150's WITH THE PRO-POWER ONBOARD OPTION.

Usage

All DECKED CargoGlide units are designed for use in stationary and level conditions only. When installed in a vehicle, the DECKED CargoGlide unit must be closed and latched securely prior to and during any vehicle movement. The vehicle must be parked in a level position prior to unlocking and extending a DECKED CargoGlide unit; otherwise, the weight of the cargo could be difficult or dangerous to move. Control loads by opening and closing slowly. Heavy, uncontrolled loads may cause bodily injury or damage your DECKED CargoGlide latch or safety stop systems.

Regular inspection is recommended.

Forces

The DECKED CargoGlide unit must be securely fastened to a base floor or other structure to prevent movement. A tipping force is applied to the unit when it is extended, which is countered by the attachments at the front (cabside) and middle of the unit. Furthermore, vehicle acceleration, cornering and braking will result in additional forces affecting your cargo and the DECKED CargoGlide unit. Impacts due to dropping a load will result in temporary higher forces impacting the fasteners and should be avoided.

Spacers, Drop Links and DECKED shoulder bolts

Many vehicle compartments have a lip on the bottom of the bed, or angled tailgates and other obstructions above the floor level. Some truck beds may require a spacer kit to clear the obstruction or tailgate angle during extension of the sliding deck. The spacers must be placed under all of the DECKED CargoGlide areas that normally contact the floor to provide necessary support. Spacer kits are available for all models; these are sold separately. Tailgate cable Drop Links and DECKED shoulder bolts will work for some models - call us with any questions at 208-806-0251.

To assure the tailgate never interferes with the DECKED CargoGlide system, there should be at minimum of 1" - 2" of vertical clearance, with no load, between the highest point on the tailgate and the lowest extended point of the DECKED CargoGlide. Test the fit and function to determine if spacers are needed BEFORE drilling into your bed. General rule: the highest point on the tailgate must be less than 3/4" above the bed floor to ensure no interference with the tailgate. Watch this video to determine the incline of your tailgate: <https://DECKED.com/pages/cargoglide-install>.

Frame Separation

DECKED CargoGlide frames can be separated to make installation and removal easier. Verify fitment in the bed with the upper deck installed. Close the tailgate. All good? Remove the upper deck for installation if you choose.

CG1000XL, CG1500XL and CG2200XL models have hinged stopper flaps on the top and middle frames. To separate frames, simply open the CargoGlide all the way until it stops, then close it a few inches so you can lift the hinged stopper flaps. While holding stoppers flaps up and being careful not to pinch fingers between the stop flaps and the cross bar, hold the latch handle open and slowly slide the deck out until the stopper flaps pass the stop cross bar. Then continue to slide frames apart while holding the frame securely. (Caution: the deck and frames are heavy and will drop abruptly as the last bearing clears the track if not held securely. Two or more people are recommended to carry the frame while it is being removed.)

Reinstallation is as easy as simply sliding the frames back into place since the hinged stoppers automatically engage as they pass the stopping points. Make sure the stops have swung into the fully down position, so the CargoGlide frames will not separate unless you manually lift the hinged stoppers.



SCAN ME

INSTRUCTION VIDEOS

CG1000XL/CG1500XL/CG2200XL INSTALLATION INSTRUCTIONS

In-depth videos can be found at <https://decked.com/pages/cargoglide-install>

NOTE: Our standard plusnut installation kit is now applicable for both steel and aluminum* vehicle beds.

***SEE ALTERNATE INSTALLATION INSTRUCTIONS BELOW FOR FORD F-150 LIGHTNING AND PRO POWER ONBOARD MODELS ONLY**

There may be installation situations where an obstruction below the vehicle bed surface prevents using a plusnut, requiring the use of long bolts and/or other fasteners that are not included. **⚠️ WARNING:** PRIOR TO DRILLING HOLES FOR PLUSNUT INSTALLATIONS, CONFIRM THAT THERE ARE NO FUEL LINES, WIRES OR OTHER OBSTRUCTIONS UNDER THE VEHICLE THAT MAY BE DAMAGED WHERE YOU WILL BE DRILLING HOLES. **⚠️**

Position & Check Clearances

1. Find a friend and place the entire DECKED CargoGlide unit into the bed of the truck or van. Push to the cabside and center the unit between the wheel wells.
2. Close the tailgate to ensure proper clearance.
 - It is recommended to first cut the flaps of the box top off and lay it in the vehicle bed to prevent scratches to the bed when positioning the DECKED CargoGlide unit/frame. Be sure to remove the box after positioning the unit/frame.



- Open the tailgate, disengage the upper deck latch and pull the deck out to the 2nd position until it locks in place.
- Measure from the cabside bulkhead to the bottom mounting frame. There should be a minimum of 1/2" clearance.
- Measure side to side from the CargoGlide to the bed wall at both the front and back of the unit to confirm it is properly centered.

3. Check to ensure nothing interferes with the location and operation of the DECKED CargoGlide, including clearance of the tailgate and/or doorway edges.
 - Loads placed on the DECKED CargoGlide may cause deflection, reducing the tailgate clearance. It is necessary that you ensure at least 1" to 2" between the lowest part of the CargoGlide and the highest point on the tailgate.
 - Optional spacer kits or drop link kits can be purchased to provide the additional clearance if needed.



CG1000XL/CG1500XL/CG2200XL INSTALLATION INSTRUCTIONS

Align Frame

- Plusnut fasteners are provided for easy installation from the top side of most vehicle beds, so you don't have to crawl under your vehicle to bolt in your DECKED CargoGlide.
- Slots are placed at each fastening point. For most vehicles, these slots ensure plusnuts can be installed on the top and in the middle of the bed ribs.
- Six (6) mounting points are needed for 52" - 56" long XL units. (See below left)
- Six (6) mounting points are needed for 63" - 73" long XL units. (See below middle - ***NOTE F-150 PPO INFORMATION***)
- Eight (8) mounting points are needed for 80" - 95" long XL units. (See below right)

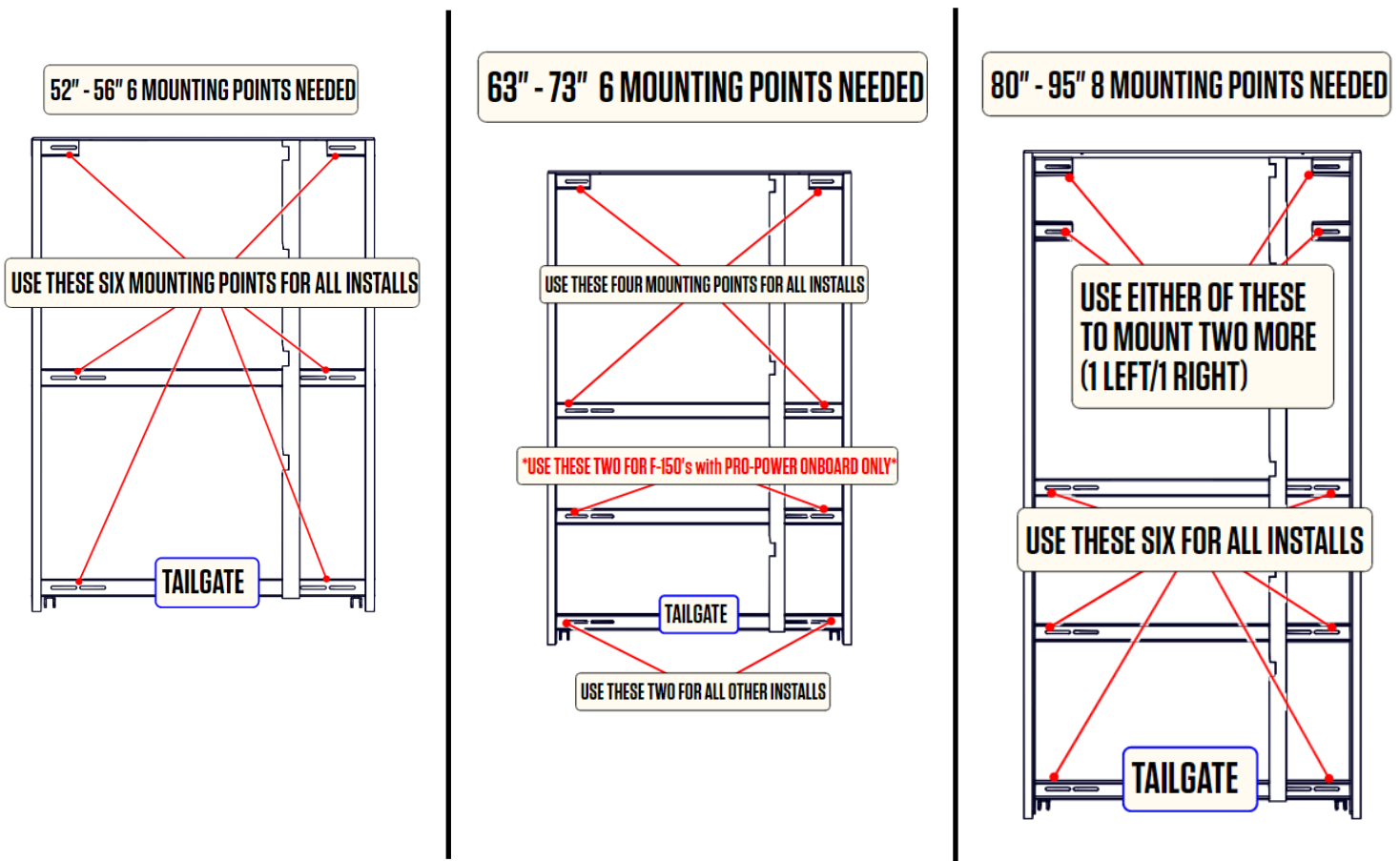

***NOTE: The F-150 equipped with any of the Pro Power Onboard options has a high-voltage line running along the tailgate edge of the bed box. This area must be avoided for any CargoGlide installation. Please follow the specific mounting locations for all F-150's (including the F-150 Lightning) with the Pro Power Onboard option.**

CG1000XL/CG1500XL/CG2200XL INSTALLATION INSTRUCTIONS

Drill Mounting Holes

1. Select a fastening position nearest the center on the top of a bed rib.
 - Align the CargoGlide bottom frame so that all mounting locations reside over the middle of a bed rib. See **DETAIL A**.
 - Holes must be placed at least 1/4" from any edges of the top bed rib surface. See **DETAIL B**.

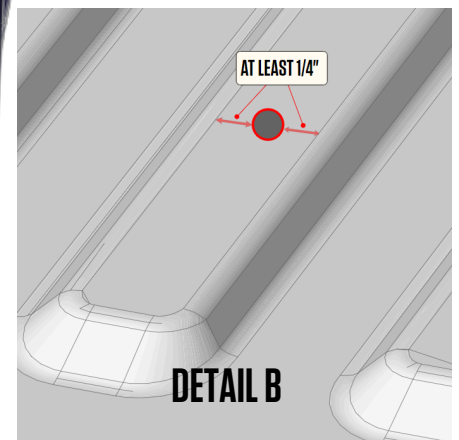
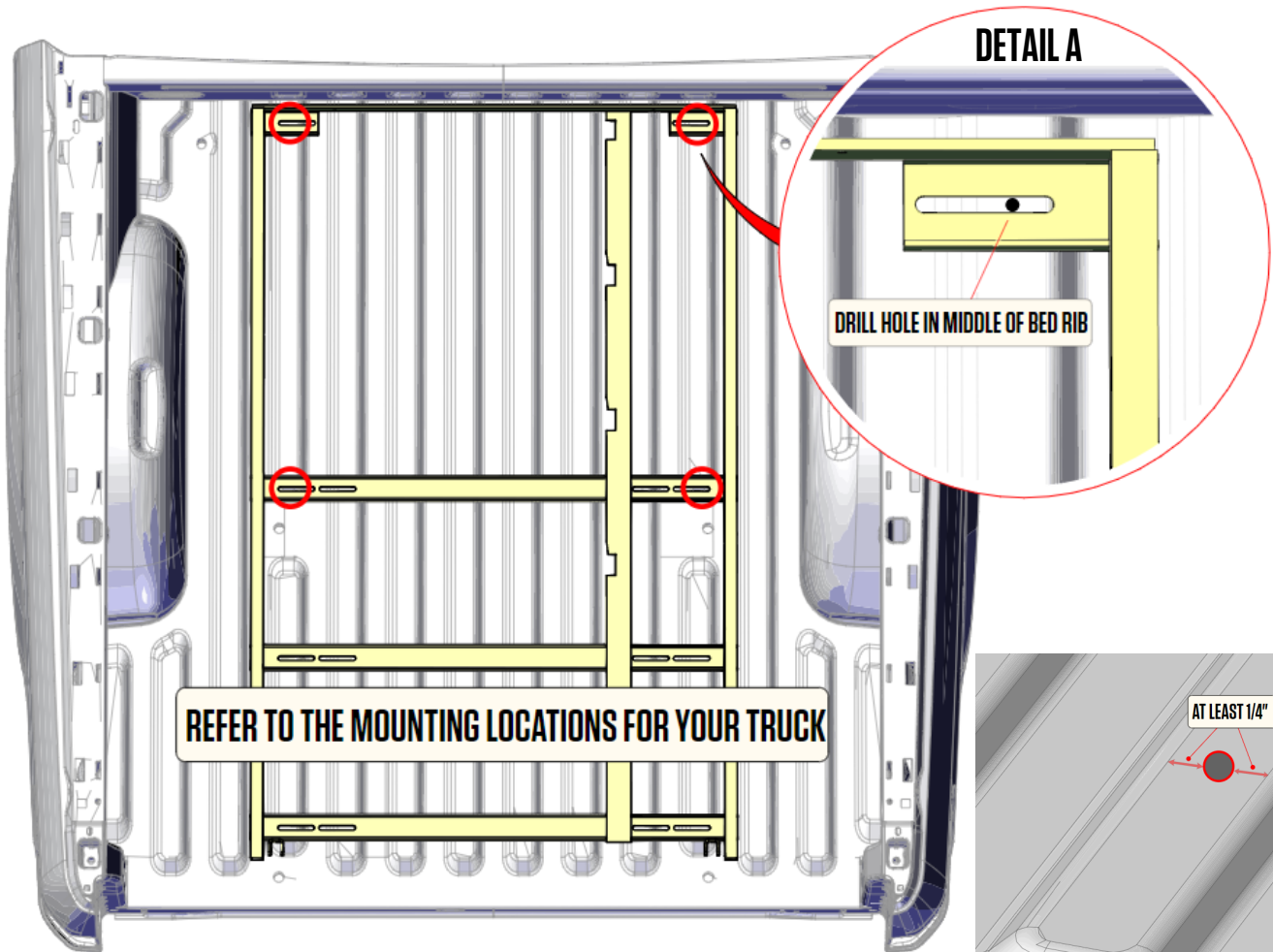

- It is not recommended to install the plusnuts in the rib valleys. If this can't be avoided, spacers will be needed to fill the gap.
- Plusnuts must be installed on flat surfaces. Do not install plusnuts on any rib slopes or uneven surfaces.
- A 5/16" installation bolt can be placed through the frame and into a pilot hole to temporarily secure the unit in place while you drill the other pilot holes.
- Move the CargoGlide frame a few inches out of your way and use a 1/2" bit to enlarge the holes you just made.
- Insert a plusnut into each hole.

CG1000XL/CG1500XL/CG2200XL INSTALLATION INSTRUCTIONS

Install Plus-Nuts

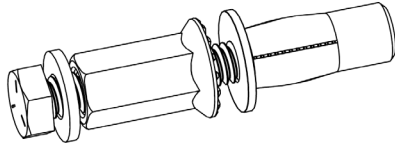

plusnut assembly

The plusnut assembly is comprised of the following components in order: (One should be pre-assembled and ready to use.)

- 5/16" x 2.5" bolt crimping bolt
- washer
- plusnut compression tool (with serrations facing the plusnut) (← image on left)
- plusnut (threaded onto the bolt)

- Using a wrench to hold the plusnut compression tool in place, use another wrench or socket to tighten the bolt into the plusnut. As you tighten the bolt, you will feel strong resistance, then light resistance, then strong resistance again as it collapses the plusnut anchor under the vehicle bed. **DO NOT OVERTIGHTEN.**
- After the plusnut has been fully compressed, remove the bolt and repeat on the other plusnuts you are installing.

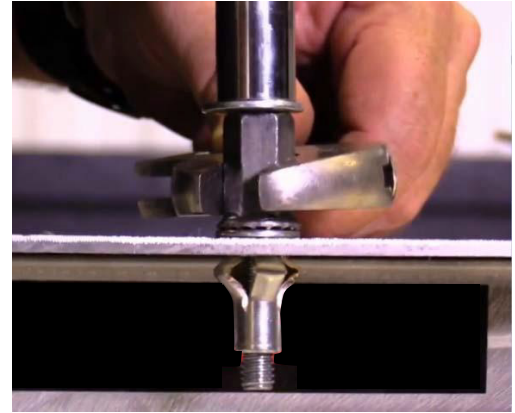

example of plusnut being compressed

Fasten Unit

- Move the frame back into place over the plusnuts.
- Install the 5/16" bolts from your installation kit. Install a washer on the bolt and install through the mounting hole in the DECKED CargoGlide frame and into the plusnut. Tighten securely in each of the mounting locations.
- Inspect periodically to ensure bolts remain securely fastened.



Test Function

Carefully slide out unit, releasing latch handle to ensure it stops at each stop position and that there is safe clearance for fingers, tailgates, etc.

IMPORTANT: Grab your favorite beverage, crack 'er open and make a toast to your installation. You did it. Immediately post a photo of your significant other, child or canine (in no order of significance - please someone show us your pet alligator) appreciating your accomplishment. Add hashtag #DECKEDUSA | @DECKEDUSA.



SAFETY CHECK!

PRIOR TO PLACING ANY CARGO ON THE UNIT, CHECK TO MAKE SURE UNIT IS WORKING PROPERLY.

- Make sure the stopper flaps are in the down position and engaged when extended.
- Failure to do this can result in the top or middle frame sliding off the frame below it causing injury or damage.
- Carefully slide out unit, releasing latch handle to make sure it stops at each stop position and that there is safe clearance for fingers, tailgates, etc.

DECKED Products – Limited Lifetime Warranty

(Valid on DECKED Products purchased on or after 8/1/2021)

DECKED LLC, (the “Manufacturer”) warrants the original purchaser only that DECKED Truck and Van Products (The “DECKED” Product) will be free from defects in material and workmanship from the date of purchase and continuing for the expected lifetime of the DECKED Product. The DECKED Product must be registered by the original purchaser with DECKED, LLC via its website at, www.decked.com/register, and a copy of the original sales receipt must be supplied to the Manufacturer at the time a warranty claim is made. This warranty terminates if the original purchaser transfers the DECKED Product to any other person or vehicle.

WHAT IS COVERED

All DECKED Products identified above on or after August 1, 2021

DECKED’s Limited Lifetime Warranty applies to US and Canadian customers only. International shipments are covered by DECKED’s 3 Year Limited Warranty.

WHAT WE WILL DO TO CORRECT PROBLEMS

Subject to the limitations and exclusions described in this limited warranty, the Manufacturer will remedy defects in workmanship or materials by providing one of the following remedies at its option and without charge to the original purchaser for parts: (a) repairing the defective portion of the DECKED Product or (b) replacing the entire DECKED Product. In addition, the Manufacturer may elect at its option not to repair or replace the DECKED Product, but rather issue to the original purchaser a refund equal to the purchase price paid for the DECKED Product or a credit to be used towards the purchase of a new DECKED Product.

WHAT IS NOT COVERED

This limited warranty expressly excludes:

- Damage or defects caused by normal wear and tear, cosmetic rust, scratches, accidents, unlawful vehicle operation, installation in a non-supported vehicle or installed in a vehicle which does not match the DECKED Product’s SKU-intended fitment or use, or modification of the product, or any types of repair of a DECKED Product other than those authorized or provided by the Manufacturer.
- Damage or defects resulting from conditions beyond the Manufacturer’s control and specifications including, but not limited to modification, misuse, overloading, or failure to assemble, install or use the DECKED Product in accordance with the Manufacturer’s written instructions or guidelines included with the DECKED Product or separately made available to the original purchaser.
- Damage to the contents of the DECKED Product or vehicle.
- TO THE EXTENT PERMITTED BY LAW, IN NO EVENT SHALL THE MANUFACTURER BE LIABLE FOR ANY INCIDENTAL, SPECIAL, INDIRECT, OR CONSEQUENTIAL DAMAGES, INCLUDING ECONOMIC LOSS, WHETHER RESULTING FROM NONPERFORMANCE, USE, MISUSE, OR INABILITY TO USE THE DECKED PRODUCT OR THE MANUFACTURER’S NEGLIGENCE.

NO OTHER EXPRESS WARRANTY APPLIES

This Limited Lifetime Warranty is the sole and exclusive warranty for DECKED Products. No employee, agent, dealer, or other person is authorized to alter this warranty or make any other warranty on behalf of DECKED LLC.

NOTIFICATION PROCEDURES

If the DECKED Product does not conform with the terms of this limited warranty, the original purchaser must promptly notify the Manufacturer in writing upon discovery of the nonconformity. In order to receive remedies under this limited warranty, a warranty claim must have been registered with DECKED LLC by the original purchaser, must describe the nature of the products nonconformity, include a copy of the original sales receipt, invoice, or other proof of purchase and be accompanied with photos or video. Repairs or modifications made to the DECKED Product by other than the Manufacturer or its authorized agent will nullify this limited warranty. Coverage under this limited warranty is conditioned at all times upon the owner’s compliance with these required registration, notification, and repair procedures.

Product registration may be performed at: <https://decked.com/register>

Warranty claims must include reciprocal contact information and may be made via certified mail or email to:

DECKED Warranty and Claims Contact info:

DECKED LLC

PO Box 885

Ketchum, ID 83340

warranty@decked.com

208-806-0251

DECKED.COM | #DECKEDUSA | @DECKEDUSA

