

USER MANUAL

ActiveAQUA[®]

HYDRO  CULTURE

MEGAGARDEN (HYDROPONIC SYSTEM)



MGSYS & MGSYSNM

OVERVIEW

Congratulations on the purchase of an Active Aqua MegaGarden system. The MegaGarden is a high performance hydroponic growing system designed with simplicity in mind. Anyone from the novice to the professional green thumb can use the MegaGarden with ease and get fantastic results. This exclusive Hydrofarm design is compact yet very productive, utilizing automated flood & drain (ebb & flow) technology, and uses less water to grow more produce. Crops grown in the MegaGarden experience dramatic growth rates as the roots are directly fed with oxygenated nutrient solution, versus conventional soil gardening which requires the roots to search for food sources in the dirt. With the assistance of a Hydrofarm grow light system such as a high intensity grow light, or a T5 fluorescent, the MegaGarden can provide year-round production for all your gardening desires!

HYDROPONICS: SIMPLE, QUICK, AND EASY

Hydroponics is simply a more efficient way to provide nutrition and water to your plants. In a soil garden, nutrients and water are randomly scattered about throughout the medium, and plants have to expend a lot of energy growing roots to find them. In a hydroponic garden, the nutrients and water are delivered directly to your plants' roots by pumping solution on timed cycles. Plants grow quicker and may be harvested sooner because they are absorbing nutrition at a faster rate.



TABLE OF CONTENTS

Overview	2
Hydroponics: Simple, Quick, and Easy	2
Assembly	5
View tube Installation	5
Support Column	5
Flood & Drain Installation	5
Pump & Tube Assembly	7
Cleaning and Maintenance	8
Cleaning (optional)	8
Special Notes and Instructions	8
Lighting	10
Temperature and Air Circulation	10
Harvest	10
GROW!T Clay Pebbles	10
Limited Warranty	12

PARTS LIST - (WHAT'S IN THE BOX)

PARTS LIST

- A** - 8 Gallon reservoir (x 1)
- B** - Grow tray with holes (x 1)
- C** - Hydrofarm planters (x 15)
- D** - Clay pebble growing media (included with some models) (x 1)
- E** - Flood & drain assembly:
 - E1. 1/2" Fill fitting (x 1)
 - E2. 3/4" Drain fitting (x 1)
 - E3. 3/4" Riser (x 1)
 - E4. 1 1/4" Riser (x 1)
 - E5. Drain screens (x 2)
- F** - View/Drain tube assembly (x 1)
- G** - Red porthole cap (x 1)
- H** - Drain hole filters (x 2)
- I** - Tray support column (x 1)
- J** - Active Aqua submersible pump (x 1)
- K** - 1/2" Inflow tube (x 1)
- L** - Hydrofarm timer (x 1)
- M** - pH test kit (x 1)
- N** - Starter cubes (x 24)



ASSEMBLY

1. Remove all of the MegaGarden components from the packaging and ensure everything is accounted for by referencing the PARTS list.

VIEW TUBE INSTALLATION

1. Remove the grommet from the view tube assembly elbow.



2. Install the grommet into the lower hole on the reservoir.

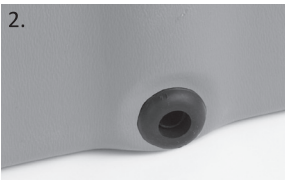

3. Re-insert the view tube drain elbow securely into the grommet.



SUPPORT COLUMN

1. Place the support column over the rounded center bottom portion of the reservoir, see Figure B.

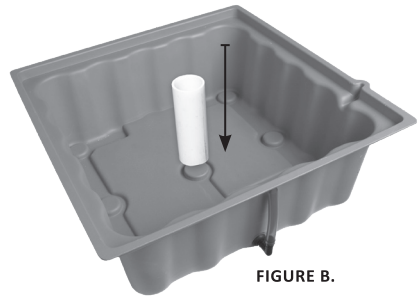

FLOOD & DRAIN INSTALLATION

1. Remove the threaded nuts and rubber washer from each fill/drain fitting.

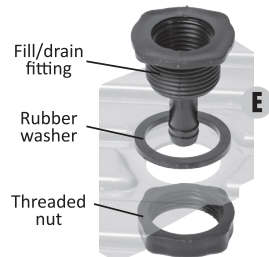

2. Insert both fittings through the top of the grow tray into the two pre-cut holes. Replace rubber washer and threaded nut to each fitting from below. Wedge the tray between the two rubber washers on each drain fitting to prevent leaking, and secure it into place with the threaded nut on the bottom.
3. Slide the $\frac{3}{4}$ " riser into the top of the $1\frac{1}{4}$ " riser. Insert the fill screen on top. Install it into the fill fitting to complete the overflow assembly.
4. Insert the remaining drain screen into the top of the $\frac{1}{2}$ " fill fitting. The complete flood & drain assembly should appear as shown in Figure C.
5. Install the (2) drain hole filters into the small holes located in the propagation tray and red porthole cap, see Figure D and F (page 6).

FIGURE C.

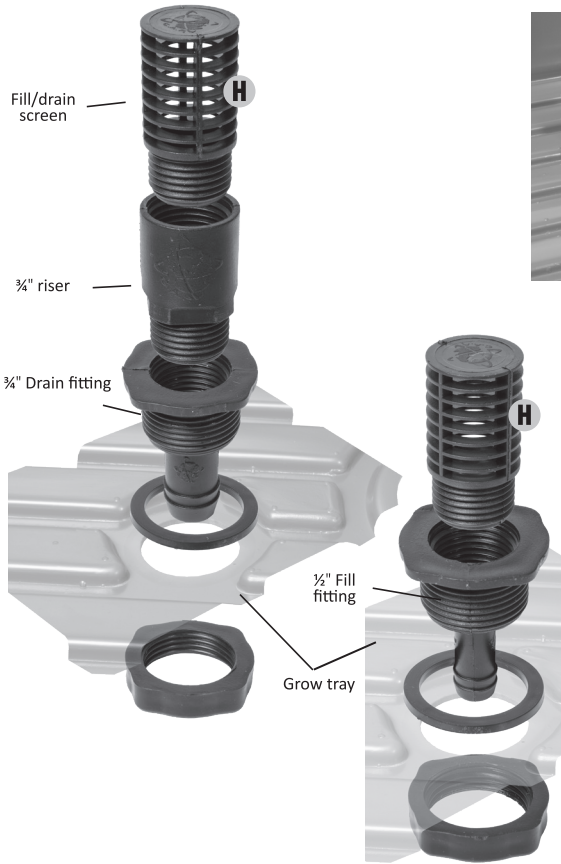
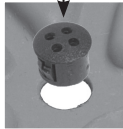

FIGURE D.



WARNING: Keep the overflow screen and drain hole filters free of debris to prevent overflow of the grow tray.

FIGURE E.

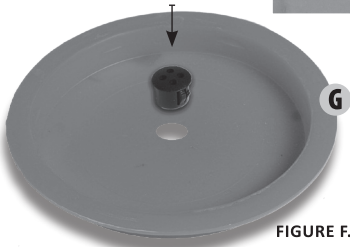

FIGURE F.



PUMP & TUBE ASSEMBLY

1. Attach the additional ½" fitting to the submersible pump (Figure G).

TIP: The slider located on the pump adjusts the water flow rate. We recommend a faster fill rate opposed to a slower one, but this is optional and customizable to suit your needs.

2. Connect the pump to the ½" fill fitting installed in the grow tray using the piece of ½" black tube (see Figure H).
3. Place the grow tray on top of the reservoir, making sure the PVC support column is in place.

NOTE: DO NOT connect the pump to the power supply unless it is fully submersed in solution. Failure to do so may cause permanent damage to the pump.

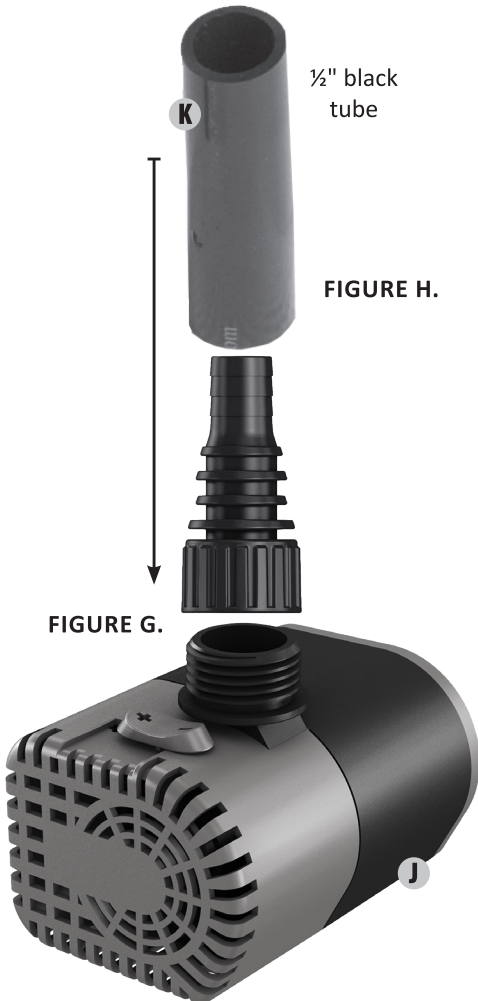

CLEANING AND MAINTENANCE

1. Unplug the pump and disconnect it from the ½" fill fitting. Remove it from the MegaGarden system and place it in a bucket or to the side for cleaning.
2. Drain the entire reservoir using the view/drain tube assembly.
3. Rinse the reservoir, grow tray, and pump using a high pressure spray nozzle. A scouring pad might be necessary to remove nutrient salt build up from the plastic.
4. Re-assemble the MegaGarden and pump assembly after all the components have been thoroughly rinsed.

CLEANING (OPTIONAL)

1. Fill the reservoir with a mixture of diluted bleach and water. Dilute at a rate of 1 oz per gallon of water.
2. Turn pump on once the reservoir is completely full. Allow it to run for approximately 30 minutes to completely clean the pump and components.
3. Drain the solution and rinse all the parts thoroughly.

SPECIAL NOTES AND INSTRUCTIONS

- Treat rockwool cubes prior to use. Run plenty of fresh water through them and soak them in a 5.5 pH solution.
- Once a healthy root mass is established from the seedling or cutting, plant the starter cube so the top of it is approximately 1.5" deep in the planter.
- Maintain a pH value of 5.5 to 6.0 in the nutrient solution for maximum nutrient uptake.
- A water temperature of 65 to 70°F is ideal for the root zone.
- Watering cycles are automated by the timer included in the package. Approximately 1 to 4 feedings per day is ideal for most stages of crop development. Take care when using the included timer that you do not inadvertently change or set the timer's manual override switch to the "on" position, as this setting will cause the pump to run constantly and could result in unhealthy conditions for your plants' roots due to the lack of a dry cycle.
- When using a new nutrient system, start off at 25–50% of the recommended dilution rate opposed to full strength. For example, if the bottle calls for 15 ml per gallon, start with 5 ml per gallon.
- Empty the reservoir completely and fill it with fresh solution at least once every 14 days to keep your garden fresh and growing well.
- Other grow mediums such as rockwool blocks, perlite, and other soilless hydroponic substrates are acceptable for use in the MegaGarden.

TROUBLESHOOTING

The most common issues arise from overwatering, nutrient overdose, insufficient lighting, and extreme temperatures. Re-check your procedures and conditions to make sure you have followed all the directions correctly.

- If the plants show signs of tip burning, flush system with fresh water, and cut back the strength of the nutrients.
- If the inflow tube is not flowing freely, check the intake on the pump.
- Inspect carefully for any insects, fungus, or mold. If you discover signs of these, consult your indoor garden supply store for pest control methods.
- Any fungicides or insecticides should be used at 10%–15% the normal rate.
- If you have used any new product that seems to have an adverse effect on your plants, flush the system.

LIGHTING

The more light you give your plants, the faster they will grow. If your growing season is short with cold temperatures, it's best to give your plants an early start indoors under our T5 lighting systems or high intensity grow lights.

Line the entire growing area with a white surface or material to reflect the maximum amount of light. Metallized film or white plastic are recommended. Flat white paint also works very well. A heavy duty grounded timer will automate the light cycle.

TEMPERATURE AND AIR CIRCULATION

Most plants thrive in temperatures between 65 and 90°F. 70–80°F is closer to optimum. Humidity should be between 45–80%. Use an oscillating fan to keep temperatures down when it's too hot, strengthen the plants, and bring in fresh air if you're growing in an enclosed area. Don't blow them over, but give them a gentle breeze for part of the day to promote air circulation. Monitor the water temperature and avoid excessive heat building in the root zone, which can damage the plants.

HARVEST

Harvest time is near when the herbs or vegetables are almost fully ripened and are changing color. Harvest the crop by cutting off the ripened produce.

GROW!T CLAY PEBBLES

GROW!T horticultural clay pebbles are made from 100% natural clay. They are clean, pH stable, and offer great aeration and drainage in hydroponics, especially in flood and drain, deep water culture, and drip feed systems. Due to their unique structure and ability to cover a large surface area, they offer the ideal environment to foster beneficial bacterial growth around the root zone, leading to naturally healthier plants.

- Extremely stable in both pH and EC
- Made from 100% natural clay
- Strong structural integrity means that they are less likely to break and compact, which helps to prevent dripper systems from getting blocked
- Pre-washed to aid in stability
- Drains freely and does not hold any excess water, providing good oxygen levels around the root; suitable for flood and drain systems, multi-pot and drip feed systems
- Pebble size 4 mm–16 mm

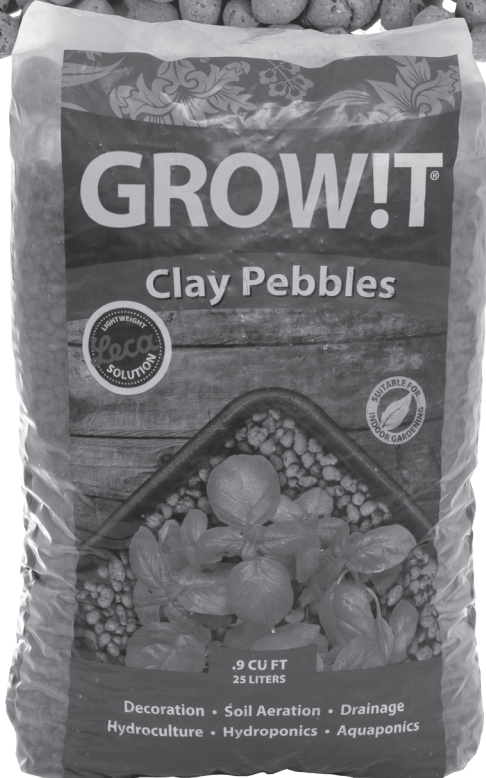

WARRANTY



LIMITED WARRANTY

Hydrofarm warrants the **MGSYS & MGSYSNM** to be free from defects in materials and workmanship. The warranty term is for 1 year beginning on the date of purchase. Misuse, abuse, or failure to follow instructions is not covered under this warranty. Hydrofarm's warranty liability extends only to the replacement cost of the product. Hydrofarm will not be liable for any consequential, indirect, or incidental damages of any kind, including lost revenues, lost profits, or other losses in connection with the product. Some states do not allow limitation on how long an implied warranty lasts or the exclusion of incidental or consequential damages, so the above limitations or exclusions may not apply to you. Hydrofarm will, at our discretion, repair or replace the **MGSYS & MGSYSNM** covered under this warranty if it is returned to the original place of purchase. To request warranty service, please return the **MGSYS & MGSYSNM**, with original sales receipt and original packaging, to your place of purchase. The purchase date is based on your original sales receipt.



Get Connected with the Hydrofarm Community:



Like us on Facebook, follow us on Twitter,
and check out *Hydrofarmtv* on YouTube and Instagram!

MGSYS & MGSYSNM Instructions revised - April 7, 2021 1:02 pm



Hydrofarm.com