



# **EtOH PRO USER MANUAL**

**Version 1.0 December 1, 2018  
Part # 1007-1052**

**ExtractCraft, LLC  
105 South Sunset Street, Unit M  
Longmont, CO, 80501  
United States  
Phone: 720-534-1242**

**customer support: [info@extractcraft.com](mailto:info@extractcraft.com)**

READ USER MANUAL BEFORE USING, AND ALWAYS FOLLOW INSTRUCTIONS.

PRINT OUT AND KEEP USER MANUAL IN A SAFE PLACE FOR EASE OF REFERENCE.

## TABLE OF CONTENTS

Safety (Warnings & Cautions).....	1
Package Contents.....	2
Unpacking & Setup.....	3
Features & Benefits.....	5
Using EtOH PRO	
Extract Mode.....	8
Purge Mode.....	11
Altitude Tuning.....	12
Care Instructions.....	13
Technical Specifications.....	14
Warranty.....	15
Contact Information.....	17
Resources.....	18
Troubleshooting.....	19

## SAFETY

### OPERATIONAL CAUTIONS

-  **CAUTION:** For your safety and convenience always follow these safety guidelines.
- For your safety always allow any metal parts to completely cool before handling.
  - Always make sure there is no ethanol spilled or present on the electrical plug connecting the kettle to the main body. This area must be checked and kept dry at all times.
  - Never leave EtOH PRO unattended during operation.
  - Place EtOH PRO well away from heat sources, direct sunlight, or places where heat may become concentrated.
  - Inspect all parts and connections and confirm proper fitting prior to each use.
  - Do not operate EtOH Pro if any parts are damaged, flaking, show excessive wear, or appear unsafe in any way.
  - Never operate the machine without the spit jar attached
  - Never overflow the reclaim jar.
  - Keep the base on the unit away from any water exposure at all times. Do not immerse or expose the base of the unit into water or liquid of any kind.
  - There is no automatic shut-off for the EtOH PRO, you must turn off power when not in operation.
  - EtOH PRO will vibrate during operation. Objects will slide off and the unit could shift position. Place on a flat, no-slip surface where the unit can not slide.

### ALCOHOL USE AND STORAGE WARNING

-  **WARNING:**
- Alcohol is extremely flammable and must be handled with great care.
  - Alcohol must be kept well away from any kind of flame or ignition sources during preparation, EtOH PRO operation, storage and at all times.
  - Keep alcohol away from children and pets.
  - Always store alcohol, including reclaimed and residual alcohol, in a safe place, away from children and pets, and in a container appropriate for storage of such material.

### SOLVENT WARNING: Only food grade ethanol

 **WARNING:** Only food-grade ethanol may be used in the EtOH PRO. Do not use methanol (wood alcohol) or any other solvents as they may be poisonous, lead to sickness or possibly death, or create fire and explosion hazards. For safe operation it's very important no other solvents other than food grade ethanol are present in the machine at any time.

## SAFETY (cont'd)

### PLANT EXTRACT WARNING



#### WARNING:

- Some plant extracts are potentially dangerous due to the toxicity of concentrated chemical components and may be harmful or even deadly if ingested or absorbed through skin or membranes.
- Some botanical oils that would do no harm in a diluted form may do serious harm in higher concentrations. The internal use of botanical oils can also pose hazards to pregnant women.
- The **flash point** (temperature at which a compound gives off sufficient vapor to ignite) of each plant extract is different. Many common oils, such as tea tree, lavender, and citrus oils are classified as flammable liquids.
- Botanical oils valued for aroma-therapeutic qualities may cause skin irritation, allergic reactions and other health problems. You must determine the hazards and handling requirements of the particular oils you extract.
- ExtractCraft makes no claims, representations, or warranties about botanical oils, their uses, or their suitability for extraction. This is simply a device for extracting botanical oils.

**IT IS THE SOLE RESPONSIBILITY OF THE USER TO ENSURE THAT THE BOTANICALS FROM WHICH YOU DESIRE TO EXTRACT OILS/ CONCENTRATES ARE SUITABLE AND SAFE FOR EXTRACTION.**

### USED MATERIAL DISPOSAL WARNING



**WARNING:** Care must be observed in disposal of any ethanol laden botanical material. If not properly disposed of, the material can create a significant fire hazard.

## PACKAGE CONTENTS

1 - EtOH PRO Base Unit

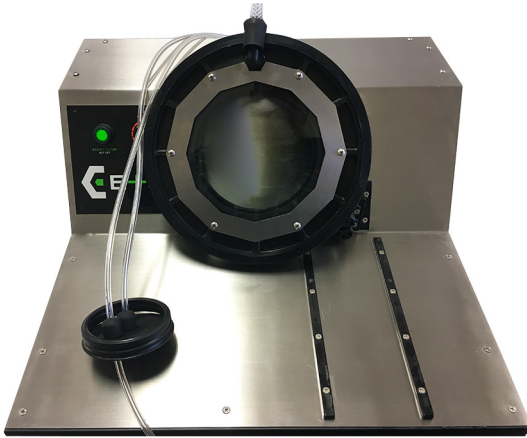

1 - Power Cord

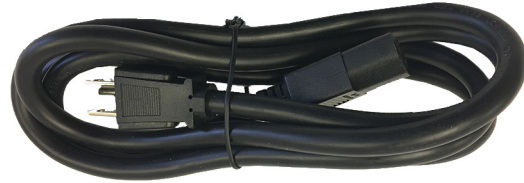

1 - Kettle Lid Holster

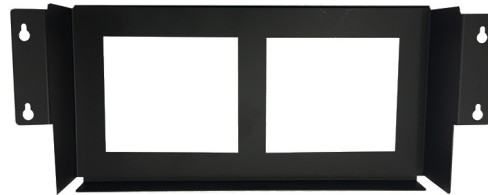

1 - Kettle



1 - Reclaim Jar holster



1 - Reclaim Jar



1 - Spit Jar



## UNPACKING INSTRUCTIONS

**When unpacking the EtOH PRO use caution to not exert undue pressure on the lids and connections attaching them to the base unit.**

- 1) Remove the four support pillars at each corner of the box.
- 2) Remove the rear lid holster laying on top, and set aside.
- 3) Carefully remove the spit jar, reclaim jar holster, reclaim jar, and power cord from the multi-partitioned cardboard support, and set aside. Remove the multi-partitioned cardboard support.
- 4) Remove the square box containing the kettle, remove kettle from box and set aside.
- 5) The only thing remaining in the box should be the EtOH PRO base platform with the kettle and reclaim jar lids attached by vacuum hoses. The base is heavy, and the attached parts are cumbersome to move so the help of a second person is advised. **IMPORTANT:** Carefully lift the base out of the box while supporting both lids so they don't get pulled, dropped, or otherwise undergo stress to the hose connections and ports. If the hose connections and ports are corrupted the unit will not function.
- 6) Confirm all parts are accounted for, if there is anything missing contact customer service as soon as possible.

## SETTING UP EtOH PRO

- 1) Connect the power cord to the back of the machine and plug into electrical socket.
- 2) Locate the power on/off switch on the back of the unit, set to "on" and confirm power is being delivered by the illumination of the green Start/Stop button.
- 3) Connect the spit jar to the only unconnected tube coming from the back, bottom corner of the unit. Use either port on the lid to connect and leave the second port open and unattached.
- 4) Level the base using the adjustable feet. **IMPORTANT:** Make sure there is plenty of clearance between the surface of the work space EtOH PRO is placed on and the bottom of the unit. The air to cool and allow the unit to function properly depends on air flow from the underside of the base.
- 5) Attach the reclaim holster to the left side (viewing from front), using the keyholes cutouts on the holster to rest on the four pre-set protruding round head screws.
- 6) Attach the kettle lid holster to the back of the base, using the key holes cutouts on the holster to rest on the four pre-set protruding round head screws.
- 7) Rest the empty reclaim jar in the holster.
- 8) Place the reclaim jar lid on the reclaim jar with hose inside jar.
- 9) Set altitude tuning (see page 12)

## FEATURES & BENEFITS OF THE EtOH PRO

- Closed ethanol recovery appliance
- 4L capacity / 1 lb dry material
- 3 Hour processing time
- Altitude specific tuning
- Dial controlled temp, 96°F-105°F
- Reclaims up to 98% of alcohol for re-use
- Non-stick chamber
- Glass lid for easy viewing
- Post processing capabilities
- High quality design & materials
- Footprint (19”d x 22”w x 12”h)
- 1-year warranty

**CONTROL PANEL:** The control panel is very easy to operate. A single dial controls it all.

**EXTRACT:** Set temp target between 96°F-105°F. EtOH PRO automatically makes all operational vacuum and temperature adjustments for optimal ethanol recovery efficiency, taking a tincture to an oil form.

**PURGE:** Set a temp target between 80°F-120°F to use the kettle as a hot plate without vacuum. Add the optional vacuum chamber lid and an auxiliary pump to use a this function like a vacuum oven for post-processing.



## KETTLE and HEAVY DUTY LID WITH VIEWING PORTAL

The kettle is easy to handle for easy loading of the tincture as well as harvesting of the oil when the process is complete. The kettle sets on a pair of stabilizing rails with guides built into the base. The lid was designed for rugged use and built to last. A very large viewing portal makes continuous monitoring of the entire process easy and convenient. This viewing feature allows the user to accurately gauge exactly when it's time to stop the process to achieve the exact desired viscosity of the crafted oil.



## KETTLE CONNECTION AND PLUGS

The power connection was designed to secure effortlessly and for easy disconnect when it's time to collect your beautifully crafted oil from the kettle.



## LID HOLSTER

On the back of EtOH PRO there is a sturdy holster to hold the lid when it's not in action. This reduces the overall operational footprint and makes handling the bulky lid simple. The holster ships unattached, but is easy to connect with the preset screws on the backside of the unit and keyhole attachment points on the holster.

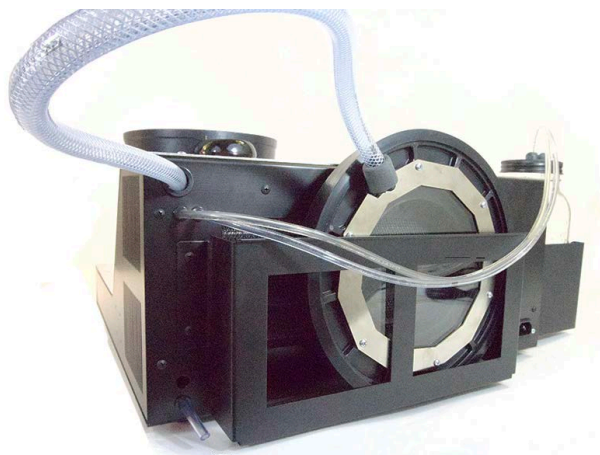

## RECLAIM CONTAINMENT & HOLSTER

Handling reclaimed ethanol can be cumbersome, messy and dangerous, so while our solution looks simple, it's amazingly convenient and useful. The custom lid is designed to work with wide mouth Ball jars and use should be limited to these jars. Using other glass jars can result in dangerous structural failure. The holster should always be used to protect the reclaim jar during use. You will notice a bulbous shaped plastic valve at the end of the long tube that goes into the reclaim jar, this is a backflow device that prevents alcohol from being sucked from the reclaim jar, back through the system, and back into the kettle with the vacuum is broken by stopping the machine. If this ever becomes disengaged, make sure it is reinstalled and in working order before using.



## SPIT JAR

It is important to attach the spit jar for collection of any ethanol expelled by the pumps and spit out of the vent tubing. It is designed for ease of use and accessibility. The spit jar must be empty every time the machine is started for operation every time the machine is started.





## POST PROCESSING WITH AUXILLARY PUMP AND LID

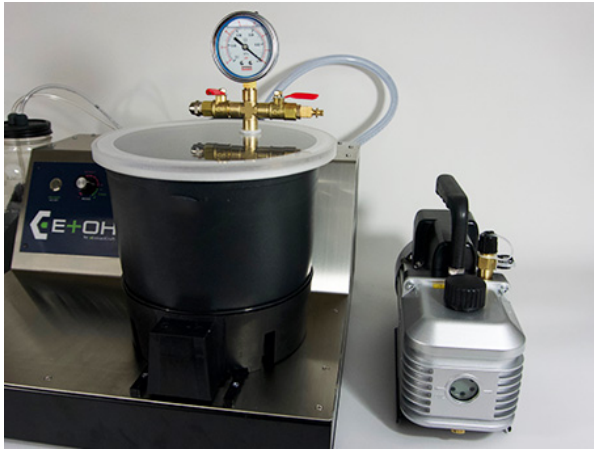

By using the Purge section of the control dial in combination with an aux vacuum pump and lid (both not included) you can post-process your extracts and concentrate into any form you like. This is useful for those trying to add stability to their end products or getting to the lowest possible level of residual ethanol.

## RUNNING EtOH PRO WITH AN AUXILLARY PUMP ASSIST

The EtOH PRO can be used with an auxiliary (aux) pump assist (not included) by plugging the power cord into the back of EtOH PRO and the vacuum line onto the empty spit jar port. The aux pump power switch should be left in the ON position and EtOH PRO will turn the pump on and off as vacuum is required. Using an aux pump will reduce pump down times and overall pump activity. The spit jar can eliminate much of the liquid ethanol from entering the aux pump, but vapor may still contaminate the oil causing damage and safety issues depending on the pump being used. If the chosen aux pump is not rated for solvent intake a cold trap should be used. All manufacturer instructions and guidelines for pump safety must be followed to be used along with EtOH PRO. It is also very important to remember if the vacuum pump is connected to the negative pressure end, you must use an in-line back-flow valve or check valve to avoid vacuum oil being sucked out of the pump into the negative pressure lines, environments, and internal pumps.

## USING EtOH PRO: EXTRACT MODE

Extract mode is used for processing an ethanol tincture, to separate the commingled oil components and ethanol that together make up a tincture. When the process is complete, the oil will remain in the kettle and the ethanol will be separated and collect in the reclaim jar.

**Tip:** It's advisable to do a test run with only ethanol to get the feel of the machine and make sure everything is operating correctly.

### STEP 1: Load Kettle With Tincture

It's best to load the kettle when it's already plugged into the base. Moving the kettle, plugging it in, or unplugging it with tincture already loaded will easily cause sloshing and spillage that will be messy and dangerous. If it's necessary to adjust the kettle once loaded, place the lid on top before doing so. Once the kettle is loaded and ready to go, place the lid on the kettle and prepare to start the process.

### STEP 2: Starting Extract Mode

- Use the dial to choose a setting in the red zone labeled EXTRACT. The approximate temp range for the red arc is 96°F-105°F. The higher temperature is more aggressive and faster while the lower is less active and slower.
  - The high end of the range would be used for fast normal processing.
  - The low setting is used for overly thick contents, for less aggressive activity in the kettle, and to avoid bumping on hot starts.
- Confirm the plugs on the kettle are fully engaged. If they are not plugged all the way in and fully connected the kettle will not generate heat for operation.
- Confirm the reclaim jar lid and kettle lid are securely in place.
- Confirm the spit jar is empty and attached.
- Push the green illuminated 'START/STOP' button one time to start processing.

#### IMPORTANT: HOT START CONSIDERATIONS

When restarting EtOH PRO while the unit and contents are still warm there is a good chance for “bumping” to occur. This means that as the contents come under vacuum and have heat reintroduced there will be a big burp of liquid that will splatter aggressively. To avoid this either wait for everything to cool down completely or turn the control dial to the lowest setting and restart the machine. Boiling should be reestablished in under 10-minutes, when this happens adjust the control dial to the performance level you prefer.

### STEP 3: Establishing Vacuum Seals

- Once EtOH PRO has been started the vacuum pumps will automatically begin providing vacuum pressure.
- The vacuum will establish in the reclaim jar first. Hold the vacuum lid in place, and once it is firmly held in place with vacuum pressure place the outer ring on the lid and gently secure. Do not over tighten the ring.
- Next check to see if the kettle lid is firmly held in place by the vacuum. If the lid is not held down by the vacuum place equal and gentle pressure on opposite sides of the plastic area of the lid for 10-30 seconds to establish the vacuum seal.

**STEP 4: Running Extract Mode**

- Once the vacuum is established and the unit is running, small bubbles should appear quickly.
- **IMPORTANT:** If the kettle is filled to maximum capacity the boiling can become very vigorous so it's important to keep an eye on it and if the foam appears to be getting sucked into the vacuum port on the lid consider turning the temp down and/or try a higher altitude setting the next run. It's best to avoid any foam being sucked into the vacuum port in order to keep the reclaim clean, but small amounts will not harm the EtOH Pro or the process. If it is substantial then the settings, temp and/or altitude, must be adjusted.
- On the highest setting it can take up to 20-minutes to see any throughput in the reclaim jar. Lower temp settings will take longer.
- As the process progresses you should see steady progress and increasing volume building in the reclaim jar as the level in the kettle reduces.
- If you are processing more than 1750 ml at one time you will need to stop the process to clear the reclaim jar when it becomes full. Once the jar is filled to the 1750 ml marks it's a good time to empty or switch out the reclaim jar as detailed next in STEP 5: Switching/Emptying Reclaim Jar Mid-Process

**STEP 5: Switching/Emptying Reclaim Jar Mid-Process  
(only necessary if processing more than 1750ml at a time)**

- As mentioned in "STEP 4", best practice is to switch/empty the reclaim jar once it reaches the 1750ml mark.
- Pushing and releasing the illuminated green button one time will stop the process and automatically release the vacuum. There can be a delay of several seconds before the vacuum is released so patience may be required.
- When the vacuum has been released, remove the lid from the reclaim jar, empty it or replace it with a clean empty jar, place the empty jar back in the holster with the lid in place, and repeat STEP 2: Starting Extract Mode and STEP 3: Establishing Vacuum Seals.
- When the vacuum is released, condensed ethanol will empty from the heat exchangers into the reclaim jar filling it more, up to another 250ml, so allowing for extra head space is important to keep in mind.
- If the reclaim jar becomes too full, past the 1750 ml mark, ethanol will get sucked backward into the system when the vacuum is released to change the jars or end the process. This isn't a big problem, but it's best to avoid so keeping a close eye on the reclaim jar is a good idea.

**IMPORTANT: HOT START CONSIDERATIONS**

When restarting EtOH PRO while the unit and contents are still warm there is a good chance for "bumping" to occur. This means that as the contents come under vacuum and have heat reintroduced there will be a big burp of liquid that will splatter aggressively. To avoid this either wait for everything to cool down completely or turn the control dial to the lowest setting and restart the machine. Boiling should be reestablished in under 10-minutes, when this happens adjust the control dial to the performance level you prefer.

**STEP 6: Deciding When to Stop the Process**

- You decide when to stop the extracting process.
- The process must be stopped manually, so be sure to monitor the EtOH PRO unit during use to ensure your desired level of consistency.
- By observing the progress through the glass portal on the lid you can estimate when the contents have reached your desired consistency. If you are looking for a concentrated tincture or a lighter viscosity, great for many

botanicals, stop the process early while the contents are still a loose like an easy flowing liquid. For a base oil to make different forms of concentrates wait until the contents are the viscosity of cooking oil or warm honey. It's completely up to your preference.

### STEP 7: How to Stop the Process

- Pushing and releasing the illuminated green button one time will stop the process and automatically release the vacuum. There can be a delay of several seconds before the vacuum is released so patience may be required.

- Remove the lid and secure in the lid holster.

**TIP:** There will probably be some condensed ethanol remaining on the lid ready to drop back into the kettle. To avoid this, refrain from tipping the lid to the side while its over the kettle.

**TIP:** Having a clean, lint-free cloth handy to wipe down the inside of the lid immediately after removing it can make keeping the equipment clean easier.

- Slide the kettle backwards to disengage from the mounted plug bracket.

- Harvest your oil from the kettle using a silicone spatula.

**IMPORTANT:** Never use anything that can scratch the surface of the kettle, even a small scratch will quickly lead to a widespread failure of the kettle surface and not covered by warranty.

- If you find that you stopped the process too early you can put the kettle back in place, start the machine, and run it a little longer until you achieve the outcome you desire.

### PERFORMANCE NOTES:

- EtOH PRO is tuned to operate in an environment with an ambient temperature of 72°F-75°F. Higher temperature environments will adversely effect performance.

- Once the vast majority of ethanol is evaporated off there may be a minor temp overshoot, but it should be quite small. Minor overshoots should not harm the EtOH PRO, impair the process, or pose a safety hazard.

## USING EtOH PRO: PURGE MODE

Purge mode is used for post processing of concentrates to further purge residual ethanol content to your desired end product requirements. This is not necessary for all forms of extracts and concentrates. Very good concentrates can be made without post-process purging, but to achieve a higher degree of stability and lower residual ethanol more expediently it can be a very useful tool.

**IMPORTANT:** If placed directly in the kettle, oils and concentrates will become very difficult to collect from the surface of the kettle after being processed in purge mode. As a result, if using purge mode, the user must place the oil/concentrate in a heat safe container or on a platinum cured silicone mat in the kettle before using purge mode.

ExtractCraft makes no recommendations, representations or warranties regarding which specific containers or mats are appropriate for use for this purpose. User assumes all responsibility for choosing and using a container or mat and for following all safety instructions for the container or mat chosen for such a purpose.

## PURGE MODE CONTROL

Purge mode is controlled by the second half of the arc controlled by the dial and depicted in green. The arc represents a temperature range of approximately 80°F-120°F.

### Using Purge Mode as a Hot Plate (heat only, no vacuum)

- 1) Put kettle in place, securely plugged into base.
- 2) Insert the oil/concentrate into the kettle in an appropriate container or on an appropriate silicone mat (not included).
- 3) Use the dial to set the desired temperature input on the green arc.
- 4) Push the green illuminated button one time to begin heat delivery.
- 5) The unit will continue to deliver heat to the base of the kettle with no vacuum until manually turned off by pushing the start/stop or turning off the power to the machine.

### Using Purge Mode as a Vacuum Oven (auxiliary lid and pump required)

- 1) Put kettle in place, securely plugged into base.
- 2) Insert the oil/concentrate into the kettle in an appropriate container or on an appropriate silicone mat (not included).
- 3) Use the dial to set the desired temperature input on the green arc.
- 4) Push the green illuminated button one time to begin heat delivery to the base of the kettle.
- 5) Place aux vacuum lid on kettle.
- 6) Attach aux pump directly to aux vacuum lid and pull desired vacuum level for purging.
- 7) Confirm with the care and safety requirements for the chosen aux pump to determine if a cold trap is necessary.

## ALTITUDE TUNING

Altitude tuning is a ground breaking technology developed by ExtractCraft designed to allow your EtOH PRO to work at peak performance regardless of vertical location. It is very important to follow the below instructions and program EtOH PRO to the nearest 1,000 feet of elevation.

The altitude only needs to be programmed once and it will be stored as the default operating altitude until it is reprogrammed otherwise.

*NOTE: While 'altitude' and 'elevation' are technically different, for our purposes we are using them interchangeably as essentially meaning the same thing.*

### DETERMINING YOUR ALTITUDE

**Option 1** - Ask Siri or Google Assistant, "What's my current elevation?"

**Option 2** - Visit [www.whatismyelevation.com](http://www.whatismyelevation.com) and enter your current location.

### STEPS TO SET ALTITUDE

1. Plug in EtOH and wait for the green button to illuminate.
2. Push and hold the button for a full 10-seconds and release.
3. Observe the lighted button flash quickly 10-times.
4. Push the button once for every 1,000 feet of elevation up to 8,000 feet:
  - Sea Level – push 0 times, wait 10-seconds for unit to reset
  - 1,000 feet – push 1 time
  - 2,000 feet – push 2 times
  - 3,000 feet – push 3 times
  - 4,000 feet – push 4 times
  - 5,000 feet – push 5 times
  - 6,000 feet – push 6 times
  - 7,000 feet – push 7 times
  - 8,000 feet – push 8 times
5. After you have entered your elevation EtOH Pro will pause for 10-seconds and the green illuminated button will flash the same number of times it was pushed to confirm the setting, once for every 1,000 feet.
6. If the repeated number of flashes is correct you're finished and ready to start your extract crafting. If it's incorrect repeat steps 1-6.

## CARE INSTRUCTIONS

It's very important to remember the EtOH PRO is an advanced piece of technology and requires a certain degree of care to keep it in top operating condition.

There are few parts on the EtOH PRO to clean. The base of the unit should never be submerged in water or any other liquid. Simply wipe the surface with a damp towel or use alcohol some alcohol for sticky residue. The kettle can be hand washed with non-abrasive detergent and a non-abrasive soft cloth. The kettle alone can be lightly subjected to a water rinse but should never be submerged and soaked in water, nor put into a dishwasher. The silicone seal around the kettle lid may be removed for cleaning, but the rest of the lid should never be disassembled.

**TIP:** To keep the kettle lid clean, wipe the inside well after every extraction before the condensed ethanol is allowed to dry and any botanical extraction residue is able to cure or harden.

**IMPORTANT:** Extracted oils, terpenes, ethanol and other chemicals can be destructive to the kettle surface if there is ANY damage to the surface and those compounds are able to work their way under the surface. It is important to inspect the kettle when first received and confirm there are no nicks and damage to the kettle surface. It is also very important to never use any hard utensils or tools in the kettle because they will easily lead to this kind of damage. This damage is **not covered by warranty** and will require the purchase of a replacement kettle.

## TECHNICAL SPECIFICATIONS

### ELECTRICAL

100-130 VAC, 50-60 HZ

650W@120 VAC, 5.5 AMPS

### THERMAL

Processing temperature range: 96F-110F

Purging temperature range: 80F-120F

Maximum ambient temperature for processing: 80F

*\*Processing and purging temp ranges may vary due to differences in ambient atmospheric conditions and elevation considerations*

*\*\*At the end of the process if the kettle is run dry or mostly dry for any amount of time you may expect a minor temperature range deviation.*

### PROGRAMMED ALTITUDE RANGE

Sea level to 8000 feet

### MECHANICAL

Dimensions: 24W x 23D x 14H

Mass: 38 lbs

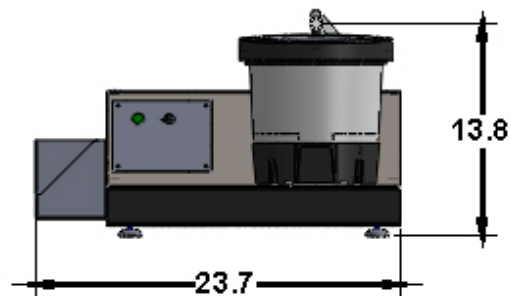
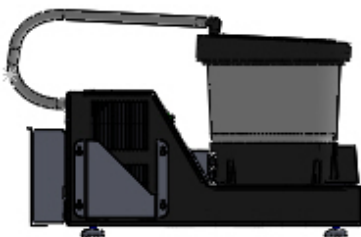
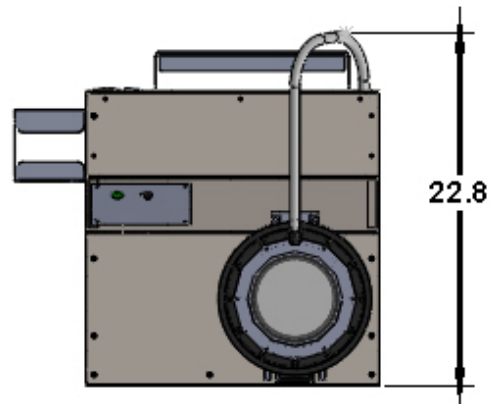



## LIMITED WARRANTY ON THE EtOH PRO

**THIS LIMITED WARRANTY GIVES YOU SPECIFIC LEGAL RIGHTS AND YOU MAY ALSO HAVE OTHER RIGHTS, WHICH VARY FROM STATE TO STATE. THE LIMITED WARRANTY CAN ALSO BE FOUND ONLINE AT [WWW.EXTRACTCRAFT.COM/WARRANTY](http://WWW.EXTRACTCRAFT.COM/WARRANTY) OR IN THE DOCUMENTATION WE PROVIDE WITH THE PRODUCT.**

**WE WARRANT THAT DURING THE WARRANTY PERIOD, THE PRODUCT WILL BE FREE FROM DEFECTS IN MATERIALS AND WORKMANSHIP. WE LIMIT THE DURATION AND REMEDIES OF ALL IMPLIED WARRANTIES, INCLUDING WITHOUT LIMITATION THE WARRANTIES OF MERCHANTABILITY AND FITNESS FOR A PARTICULAR PURPOSE TO THE DURATION OF THIS EXPRESS LIMITED WARRANTY. SOME STATES DO NOT ALLOW LIMITATIONS ON HOW LONG AN IMPLIED WARRANTY LASTS, SO THE ABOVE LIMITATION MAY NOT APPLY TO YOU. OUR RESPONSIBILITY FOR DEFECTIVE GOODS IS LIMITED TO REPAIR, OR REPLACEMENT AS DESCRIBED BELOW IN THIS WARRANTY STATEMENT.**

### **WHO MAY USE THIS WARRANTY?**

ExtractCraft ("we") extend this limited warranty only to the consumer who originally purchased the product ("you"). It does not extend to any subsequent owner or other transferee of the product. Further, we strongly urge caution when purchasing from Amazon and Ebay. Amazon and Ebay online purchases from sellers not included in the "AUTHORIZED SELLERS" list below will not be covered by the ExtractCraft warranty and will not be eligible to be serviced by ExtractCraft. ExtractCraft reserves the right to update and amend the Authorized Sellers list without notice. The ExtractCraft warranty does not cover purchases outside of our authorized dealers and units will not be eligible for servicing by ExtractCraft.

**AUTHORIZED SELLERS:** All brick and mortar store sellers. All independent website online sellers. ExtractCraft on Amazon. ALL other Amazon and Ebay sellers are UNAUTHORIZED and will not be covered by warranty or serviced by ExtractCraft.

### **WHAT DOES THIS WARRANTY COVER?**

This limited warranty covers defects in materials and workmanship of the EtOH PRO (the "product") for the Warranty Period as defined below.

### **WHAT DOES THIS WARRANTY NOT COVER?**

This limited warranty does not cover any damage due to: (a) transportation; (b) storage; (c) improper use; (d) failure to follow the product instructions or to perform any preventive maintenance; (e) modifications; (f) unauthorized repair; (g) normal wear and tear; or (h) external causes such as accidents, abuse, or other actions or events beyond our reasonable control.

### **WHAT IS THE PERIOD OF COVERAGE?**

This limited warranty starts on the date of your purchase and lasts for one year (the "Warranty Period"). The Warranty Period is not extended if we repair or replace the product. We may change the availability of this limited warranty at our discretion, but any changes will not be retroactive.

## LIMITED WARRANTY ON THE EtOH PRO (continued)

### WHAT ARE YOUR REMEDIES UNDER THIS WARRANTY?

With respect to any defective product during the Warranty Period, we will, in our sole discretion repair or replace such product (or the defective part) free of charge. We will also pay for shipping and handling fees to return the repaired or replacement product to you if we elect to repair or replace the defective product.

### HOW DO YOU OBTAIN WARRANTY SERVICE?

To obtain warranty service, you must email our Customer Service Department at [info@extractcraft.com](mailto:info@extractcraft.com) during the Warranty Period to obtain a Defective Merchandise Authorization ("DMA") number. No warranty service will be provided without a DMA number.

### LIMITATION OF LIABILITY

THE REMEDIES DESCRIBED ABOVE ARE YOUR SOLE AND EXCLUSIVE REMEDIES AND OUR ENTIRE LIABILITY FOR ANY BREACH OF THIS LIMITED WARRANTY. OUR LIABILITY SHALL UNDER NO CIRCUMSTANCES EXCEED THE ACTUAL AMOUNT PAID BY YOU FOR THE DEFECTIVE PRODUCT, NOR SHALL WE UNDER ANY CIRCUMSTANCES BE LIABLE FOR ANY CONSEQUENTIAL, INCIDENTAL, SPECIAL OR PUNITIVE DAMAGES OR LOSSES, WHETHER DIRECT OR INDIRECT.

SOME STATES DO NOT ALLOW THE EXCLUSION OR LIMITATION OF INCIDENTAL OR CONSEQUENTIAL DAMAGES, SO THE ABOVE LIMITATION OR EXCLUSION MAY NOT APPLY TO YOU.

## CONTACT INFORMATION

**Address:**

ExtractCraft, LLC  
105 S. Sunset St., Ste M  
Longmont, CO 80501  
USA

**Email:** [info@extractcraft.com](mailto:info@extractcraft.com)

**Phone:** (720) 534-1242

## RESOURCES

Here are some great resources for you to learn more about ethanol extraction and the ExtractCraft equipment.

### **ExtractCraft Website:**

<http://www.extractcraft.com>

### **ExtractCraft YouTube Channel:**

Lots of how-to and technical support videos.

<https://www.youtube.com/c/ExtractCraftVideos>

### **Blog For Ethanol Extraction:**

*Great place to learn many techniques, uses of equipment, and general knowledge (wide range of topics so 21 years and older only).*

<https://extractcrafter.com>

### **Great Facebook User Groups:**

#### 1) "ExtractCraft Users Group" - Main Group

Unrestricted content group (wide range of topics so 21 years and older only).

<https://www.facebook.com/groups/921284877977347/>

#### 2) "ExtractCraft Culinary and Aroma Extraction Arts" Group

Content restricted to culinary and aroma extraction subjects.

<https://www.facebook.com/groups/183294065570985/>

## TROUBLE SHOOTING

<u>PROBLEM</u>	<u>RECOMMENDED ACTIONS</u>
<b>No Boiling in Kettle</b>	<ul style="list-style-type: none"> <li>- Make sure the kettle is plugged in all the way until you feel the SNAP for it to be fully engaged.</li> <li>- Reset altitude to confirm it's programmed.</li> <li>- Try setting altitude 1,000 feet lower.</li> <li>- Confirm you are using clean and uncontaminated 190-proof (or higher) ethanol.</li> <li>- Confirm the control dial is in the red EXTRACT arc and not passed it into the green PURGE zone.</li> </ul>
<b>Slow Boil/Low Production</b>	<ul style="list-style-type: none"> <li>- Make sure altitude is set properly, and lower by 1,000 if necessary.</li> <li>- Aerate the alcohol or tincture. You do this by putting the alcohol or tincture in a glass jar with plenty of head space and give it a good shake, the load into kettle and start Extract mode.</li> </ul>
<b>Boiling too Aggressive</b>	<ul style="list-style-type: none"> <li>- Turn the control dial down to a lower setting.</li> <li>- Try using an altitude setting 1,000-feet higher.</li> </ul>
<b>Aggressive Splattering</b>	<ul style="list-style-type: none"> <li>- Turn the control dial down to a lower setting.</li> <li>- Try using an altitude setting 1,000-feet higher.</li> </ul>
<b>Can't Achieve Vacuum</b>	<ul style="list-style-type: none"> <li>- Apply slight pressure on opposite sides of the hard plastic areas of the kettle lid for 10-20 seconds until vacuum is established.</li> <li>- Confirm reclaim jar lid vacuum seal has been achieved by checking without the screw down support ring in place.</li> <li>- Confirm the screw down ring for the reclaim jar lid hasn't disjoined the reclaim jar silicone seal.</li> <li>- Confirm kettle lid has vacuum established.</li> <li>- Confirm kettle lid is centered and seated properly on the kettle.</li> <li>- Make sure the kettle lid's silicone seal is seated properly on the lid disk.</li> </ul>
<b>No Vacuum Seal</b>	<ul style="list-style-type: none"> <li>- Apply slight pressure on opposite sides of the hard plastic areas on Kettle Lid of the kettle lid for 10-20 seconds until vacuum is established.</li> <li>- Confirm kettle lid is centered and seated properly on the kettle.</li> <li>- Make sure the kettle lid's silicone seal is seated properly on the plastic lid disk.</li> </ul>
<b>Pumps Running Continuously</b>	<ul style="list-style-type: none"> <li>- See recommended action for trouble shooting section Continuously "Can't Achieve Vacuum" above.</li> </ul>
<b>Kettle Seal Shifting During Operation</b>	<ul style="list-style-type: none"> <li>- A little movement is normal and should not affect operation.</li> <li>- Make sure the seal is seated properly around the kettle lid hard plastic disk.</li> <li>- If the seal slides excessively there may be a need for a large zip tie for support.</li> <li>- There is currently a new seal being designed to avoid this problem and will be made available to anyone having difficulties when it is completed.</li> </ul>
<b>Start/Stop button Flashing</b>	<ul style="list-style-type: none"> <li>- Steady flashing indicates the kettle is not fully engaged, and needs to be inserted further.</li> <li>- Three fast flashes repeating indicates that the vacuum seal is not established and both the reclaim jar lid and kettle lid should be checked for proper placement and seal.</li> </ul>