

TABLE OF CONTENTS

SAFETY INSTRUCTIONS	2	SYSTEM SET UP & CHECKOUT	9
SPECIFICATIONS	3	Installer Test Mode	10
SET UP DEHUMIDIFIER FOR INSTALLATION	4	START UP AND SEQUENCE OF OPERATION	11
Packaging Content	4	Using the Dehumidifier Control	11
Duct Collars	4	Using Model A77 Remote Control	11
Control Location	5	MAINTENANCE	11
LOCATION CONSIDERATIONS	5	Clean or Replace the Filter	11
DRAIN INSTALLATION	6	Drain and Drain Insert Inspection	12
Leveling	7	Removing and Reinstalling the Drain Insert	12
Condensate Pan, Condensate Pump and Float Switch	7	TROUBLESHOOTING	13
MODEL A77 – REMOTE CONTROL AND WIRING	8	Table 2 – Diagnostic Codes	13
Alternate External Controls	8	Table 3 – Troubleshooting Guide	14
		SERVICE PARTS	15
		LIMITED WARRANTY	16

READ AND SAVE THESE INSTRUCTIONS

SAFETY INSTRUCTIONS

WARNING

1. 120 Volts may cause serious injury from electric shock. Disconnect electrical power before starting installation or servicing. Leave power disconnected until installation/service is completed.
2. Sharp edges may cause serious injury from cuts. Use care when cutting plenum openings and handling duct work.
3. Dropping may cause personal injury or equipment damage. Handle with care and follow installation instructions.

CAUTION

1. Read all instructions before beginning installation.
2. Improper installation may cause property damage or injury. Installation, service, and maintenance must be performed by a qualified service technician.
3. Do not use in pool applications. Pool chemicals can damage the dehumidifier.
4. Do not use solvents or cleaners on or near the circuit board. Chemicals can damage circuit board components.
5. Wait 24 hours before running the unit if it was not shipped or stored in the upright position
6. Do not use dehumidification to prevent window condensation in the winter. To address window condensation, use ventilation to lower indoor humidity in the winter.
7. This appliance is not intended for use by persons (including children) with reduced physical, sensory or mental capabilities, or lack of experience and knowledge, unless they have been given supervision or instruction concerning use of the appliance by a person responsible for their safety.
8. If the supply cord is damaged, it must be replaced by a special cord or assembly available from the manufacturer or its service agent.

SPECIFICATIONS

TABLE 1 – SPECIFICATIONS	Model A100	
Unit Weight	64 lbs	
Capacity (AHAM DH-1-2008 80°F, 60% RH)	100 pints per day @ 280 CFM	
Efficiency	2.6 L/kW-hr (5.7 pints/kW-hr) @ 80°F, 60% RH	
Power (115 VAC, Single Phase, 60Hz)	6.9 Amps operating current	
Dehumidifier Inlet Air Conditions	Dehumidification: 50°F – 104°F, 40°F dew point minimum Ventilation: 40°F – 140°F, 0% RH – 99% RH (non-condensing)	
Filter	MERV 11	
Airflow	External Static Pressure ("w.c.)	Airflow (CFM)
	0.0	280
	0.2	245
	0.4	210
	0.6*	175

*Maximum design external static pressure.

SET UP DEHUMIDIFIER FOR INSTALLATION

IMPORTANT: Cut the strap securing the compressor shipping support bracket and remove the strap and shipping bracket. See **FIGURE 1**.

PACKAGING CONTENT

1. Dehumidifier
2. 10" Inlet/Outlet Collars
3. Installation and Operating Instructions
4. Parts Bag
 - a. #10 x 1/2 Screws (9)
 - b. Threaded Barbed Fitting for Drain Connections
 - c. Torx Bit
5. 10 Foot, 3/4" Drain Tube

FIGURE 1 - REMOVE SHIPPING BRACKET

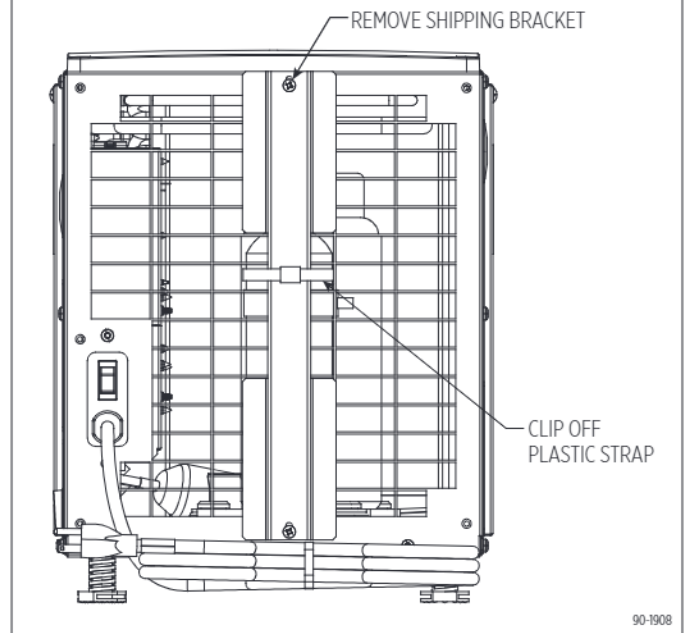

DUCT COLLARS

If suspending the unit, attach the inlet and outlet duct collars as shown in **FIGURE 2**; the outlet cover does not need to be moved. If placing the unit on the floor, remove the outlet cover, install the outlet collar to the top of the unit, and relocate the cover to the end of the unit (see **FIGURE 3**), and attach the inlet duct collar.

FIGURE 2 - HANGING INSTALL

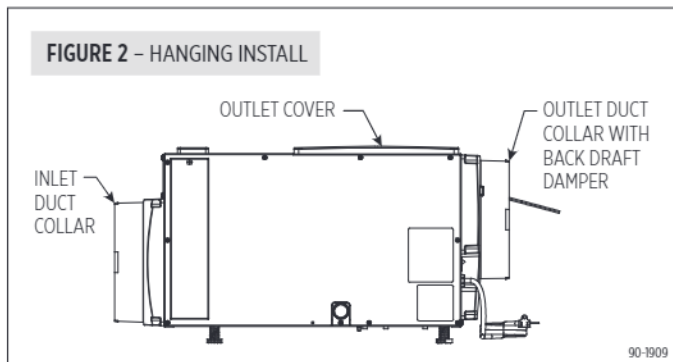
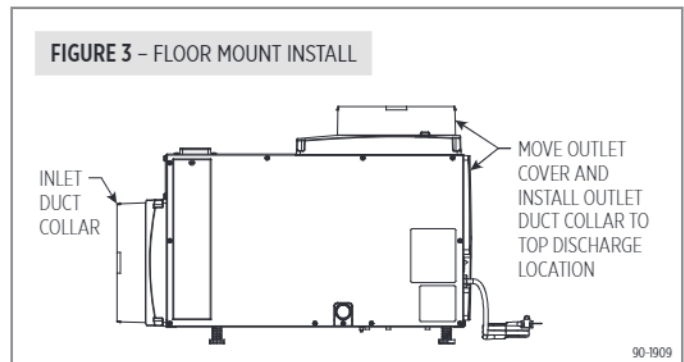

FIGURE 3 - FLOOR MOUNT INSTALL



CONTROL LOCATION

The on-board control can be located on the top of the dehumidifier or can be relocated to the front of the dehumidifier if the control cannot be seen/accessed in the top orientation. It may also be rotated 180 degrees in either orientation as shown in **FIGURE 5**.

To move the control:

1. Remove the front control panel cover.
2. Remove the filter access door and filter.
3. Detach the on-board control by removing the four (4) screws around the control. **NOTE:** Use one hand to support the bottom of the on-board control when removing.
4. Keep the control in the unit and relocate to the front access hole.
5. Secure the control with the same four screws used to attach the control to the top of the unit.
6. Secure the control panel cover to the top of the unit.

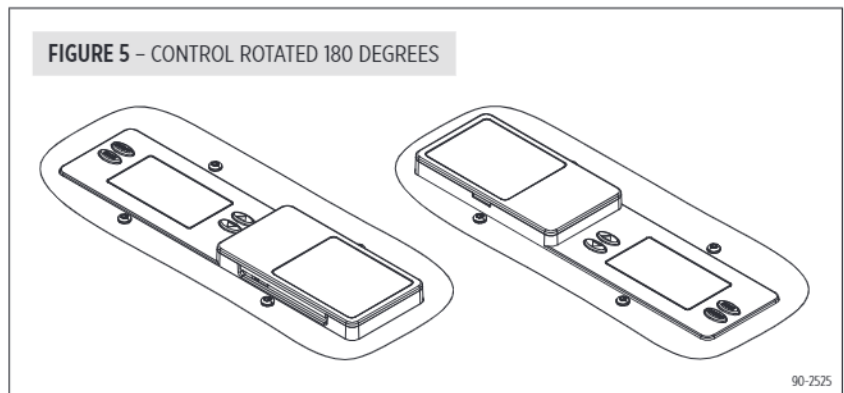
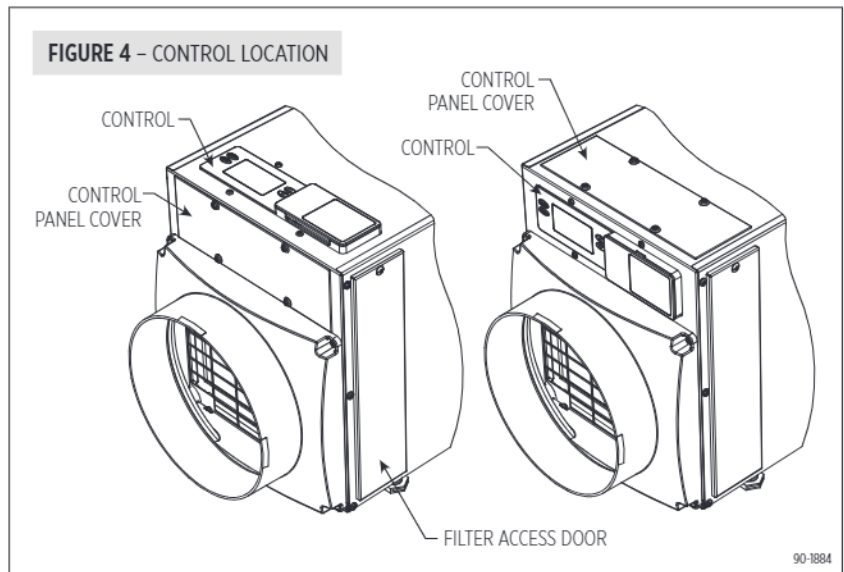

LOCATION CONSIDERATIONS

- Allow sufficient clearance for filter removal and to prevent airflow obstruction
- Electrical service access will require the removal of the side panel shown. Allow sufficient space for service on this side of the unit.
- When suspending the unit, a condensate pan with float switch is recommended to prevent any leaks that may occur due to unforeseen drain line obstructions.

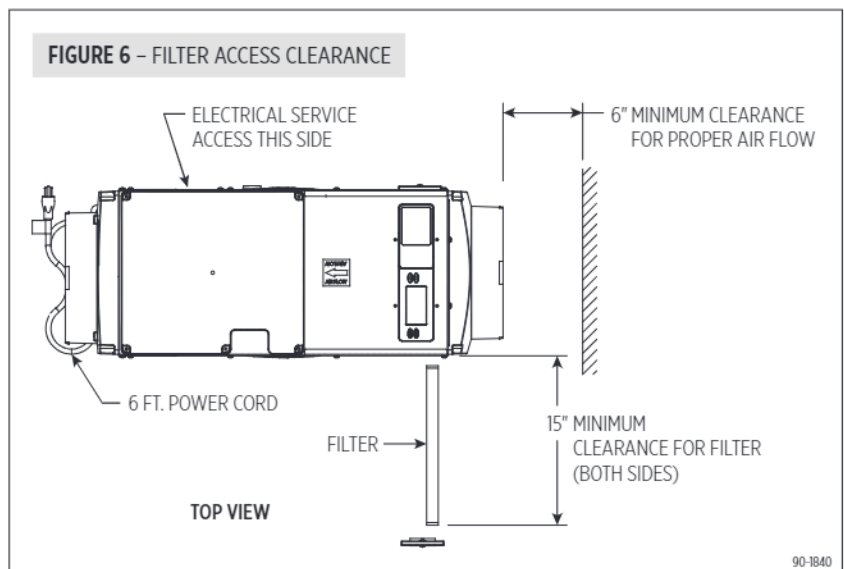

DRAIN INSTALLATION

The drain outlet on the dehumidifier can be hard piped using a 3/4" PVC Slip x 3/4" MNPT fitting and 3/4" nominal drain tubing or the provided 3/4" MNPT x 3/4" hose barb fitting. 3/4" clear PVC tubing can be used to drain the dehumidifier. Always maintain a constant downward slope from the dehumidifier to the drain and do not allow soft tubing to curl up which may result in air lock.

NOTE: PTFE thread seal tape is recommended for the threaded connection and **hand tighten only**. If hard pipe is used, PVC primer and cement is recommended for the slip fit connection. Remove drain insert before priming and gluing in the PVC fitting. Replace drain insert after PVC glue has fully dried.

⚠ CAUTION

Do not damage drain insert. The drain insert is a critical feature of the dehumidifier drain management system.

⚠ WARNING

Running the dehumidifier without the drain insert can lead to condensate leaks. See **FIGURE 7**.

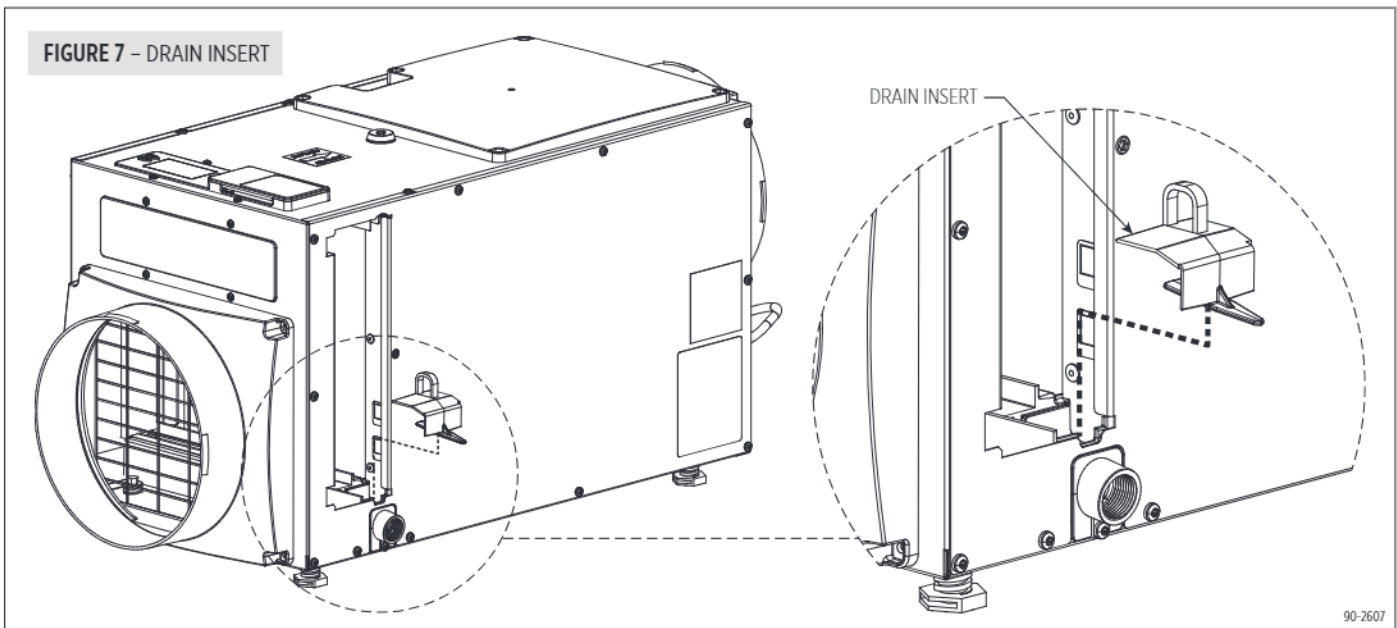

LEVELING

The feet can be adjusted to level the unit and accommodate drain fittings and secondary condensate pans as required. Refer to top mounted bubble level and adjust feet until bubble is within the outer circle.

Leveling is required to ensure proper drainage from the dehumidifier. See **FIGURE 8**.

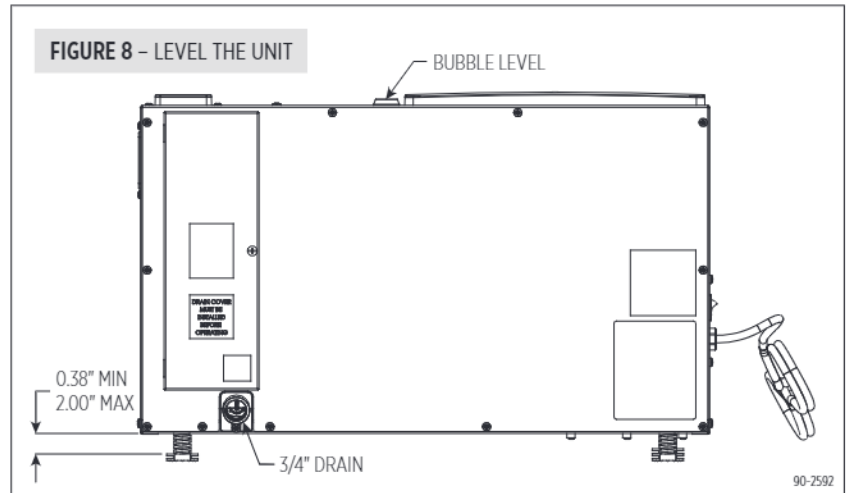

CONDENSATE PAN, CONDENSATE PUMP AND FLOAT SWITCH

A condensate pan is recommended when suspending the dehumidifier over the canopy. Adhere to local codes regarding draining of the condensate pan. If a condensate pump is needed, install it in the condensate pan as well.

Install a condensate overflow safety switch (i.e. float switch) in the condensate pan, remove the factory installed jumper wire between the Float Switch terminals on the control and wire the float switch to the dehumidifier as shown in **FIGURE 9**. Overflow safety switches on condensate pumps can be wired to the Float Switch terminals in a similar fashion.

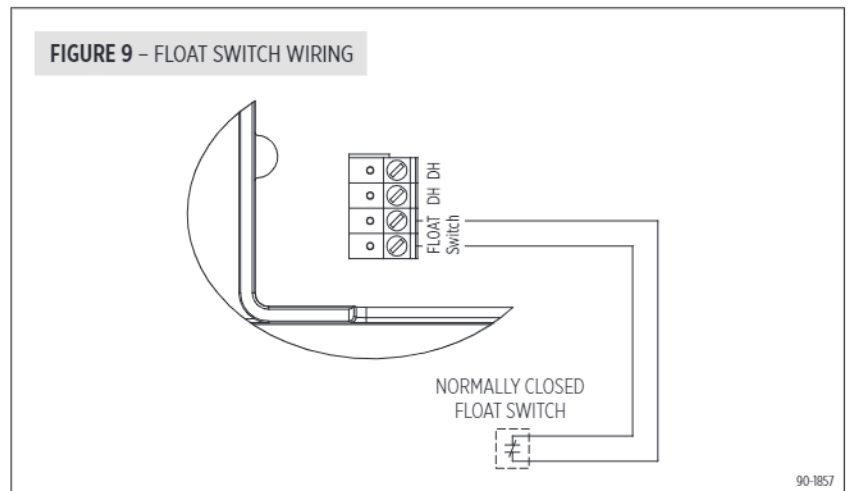

MODEL A77 – REMOTE CONTROL AND WIRING

NOTE: Use 18-22 AWG wire for control wiring.

Humidity can be controlled using the internal dehumidifier control, a Model A77 control or a different external control like a thermostat.

Installing an external control eliminates the need to run the dehumidifier blower for sampling as the control is constantly measuring the humidity close to the canopy. When the humidity level rises above the setting, the dehumidifier is turned on.

To install and use the Model A77 control, complete ALL steps:

1. Unplug the dehumidifier or turn off power to the circuit at the breaker or fuse.
2. Run a 4-wire thermostat cable (use 18–22 AWG wire) from the Model A77 to the control of the dehumidifier.
3. Trim about 1/4" of insulation from the end of the wires on each end. Insert the wire into the terminals as shown in **FIGURE 10** and tighten to secure.
4. Restore dehumidifier power. There is a delay of three minutes after restoring power before the dehumidifier will respond to the control.
5. Set up the dehumidifier to **ENABLE REMOTE** control as shown on page 9.
6. See **USING THE MODEL A77 OR EXTERNAL CONTROL** on page 9 for start up instructions.

The Model A77 will measure the relative humidity and turn the dehumidifier on and off to control the humidity level to the desired setting. The humidity setting can be adjusted from the control while the display allows easy access and monitoring of the humidity level in the space. It is recommended that the Model A77 be mounted at/near canopy height. Shield the Model A77 from direct exposure to HPS or LPS lighting.

Press the ON button on the Model A77 to turn on the control. The UP/DOWN arrow buttons are used to set the desired humidity setting. At all other times, the Model A77 will display the measured humidity level. Reference the Model A77 Installation and Operating Instructions for set-up.

ALTERNATE EXTERNAL CONTROLS

Alternatively, use any other humidity control system as long as it has a dry contact, normally open output dedicated to controlling the dehumidifier.

When using an external control, set up the dehumidifier to **ENABLE EXTERNAL** control as shown on page 9. Reference the installation literature provided with the alternative control for wiring, set-up and operating details.

FIGURE 10 – MODEL A77 REMOTE CONTROL WIRING

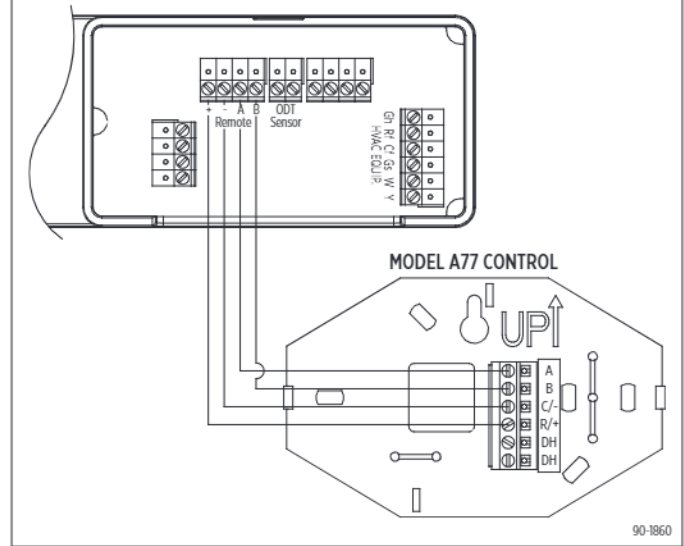
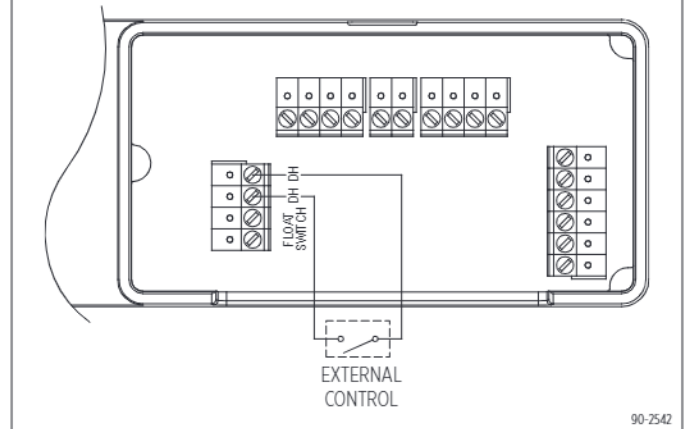

FIGURE 11 – ALTERNATE EXTERNAL CONTROL WIRING



SYSTEM SET-UP & CHECKOUT

Skip set up and proceed to **INSTALLER TEST MODE** on page 10 unless:

- A Model A77 or other external control is to be installed
 - changing the air sampling rate
1. Make sure the wire access cover has been snapped back onto the on-board control.
 2. Plug unit in and turn power switch to ON.
 3. The on-board control screen should display OFF.

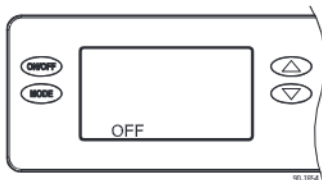

NOTE: If the display backlight is not on, the first button press (any button) will only turn on the backlight. Press the button a second time to achieve function.

4. Hold the MODE button on the on-board control for 3 seconds to enter the Installer Set-up Menu.
5. Navigate through the following screens to set up the dehumidifier for the installed application.

Use the UP or DOWN buttons to select items and use MODE to switch to the next set-up option. To exit installer set-up, all options must be scrolled through using the MODE button.

6. After the installer set up options have been completed, DONE will blink for 3 seconds and the control will return to the OFF screen.

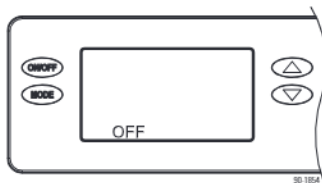
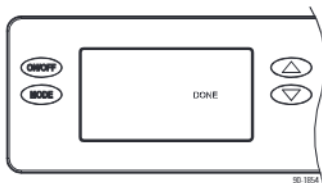

REMOTE CONTROL

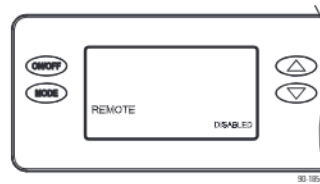

If not installing an A77, leave DISABLED and press MODE to go to the next screen..

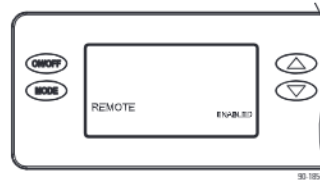

If installing an A77, use the UP or DOWN button to select ENABLED, then press MODE to go to the next screen.

EXTERNAL CONTROL

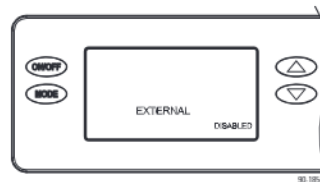

If using the dehumidifier on-board control, leave DISABLED and press MODE to go to the next screen.

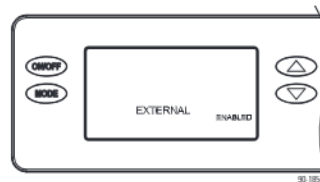

If using a Model 8800 series thermostat or alternate control as an external control, use the UP or DOWN button to select ENABLED, then press MODE to go to the next screen.

AIR SAMPLING



Use the UP or DOWN button to adjust how frequently the dehumidifier samples the air to determine whether or not to dehumidify. Fewer minutes means the dehumidifier will sample more

frequently to minimize humidity swings, but increases cost to operate due to more frequent fan operation. Press MODE when done to move to the next screen.

RH OFFSET

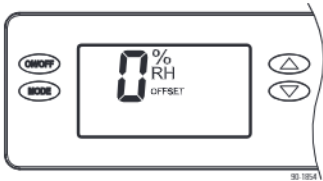

An offset can be applied to the on-board humidity reading to avoid discrepancies with other humidity measuring devices in the room. Use the UP or DOWN button to select an offset from -5% to 5%. Press MODE to exit the installer set-up screens.

INSTALLER TEST MODE

If everything is properly wired, the dehumidifier and all of the wired components will turn on and off during Installer Test Mode to demonstrate that all are properly operating. Installer Test Mode lasts for four (4) minutes. If the ON/OFF button is pressed during test mode, the dehumidifier will exit Installer Test Mode and return to the OFF screen.

DEHUMIDIFICATION ONLY

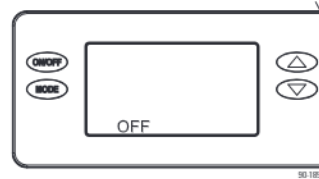

If the dehumidifier is not already OFF, press the ON/OFF button to turn it off.

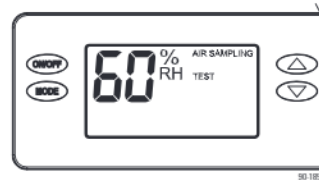

Press and hold the ON/OFF button and MODE buttons for 3 seconds. The measured humidity, AIR SAMPLING and TEST will show on the display.

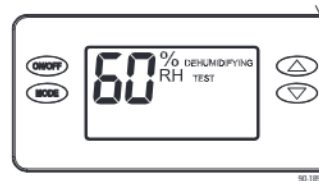

After three (3) minutes the dehumidifier compressor will turn on and DEHUMIDIFYING will replace AIR SAMPLING on the control screen.

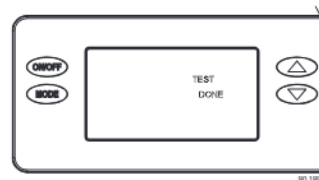

After one minute of compressor operation, all outputs will turn off and DONE will blink for 3 seconds and then return to the OFF screen.

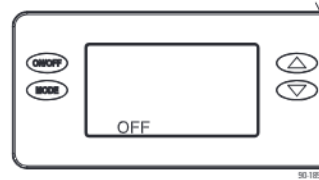

START UP AND SEQUENCE OF OPERATION

USING THE DEHUMIDIFIER CONTROL

1. Press the ON/OFF button to turn the dehumidifier control ON. The display will show the current setting, and the dehumidifier blower will turn on to start sampling the air.
The setting will be replaced by the measured humidity and "AIR SAMPLING" will show on the display.
2. Use the UP or DOWN button to adjust the humidity setting as desired.
3. After three (3) minutes of sampling, the measured humidity will be compared to the setting:
 - a. If the humidity is above the setting, the dehumidifier compressor turns on and "AIR SAMPLING" will be replaced by "DEHUMIDIFYING". The compressor remains on until the measured humidity falls 3% RH below the setting.
 - b. If the measured humidity is below the setting, the blowers turn off and the display returns to showing the RH setting.
4. The dehumidifier will sample again after the number of minutes selected during the **AIR SAMPLING** portion of the System Set Up (see page 10), or any time the humidity setting is lowered.

USING THE MODEL A77 REMOTE CONTROL

1. Press the ON/OFF button to turn the dehumidifier control ON. "REMOTE" will show on the display to indicate that it's set to communicate with the Model A77 remote control.
2. At the Model A77, press the ON button; the Model A77 will display the measured RH.
3. Use the UP or DOWN button on the Model A77 to adjust the humidity setting as desired.
4. If the RH measured by the Model A77 rises above the setting, the dehumidifier will turn on. "DEHUMIDIFYING" will appear on the dehumidifier control display to show that the Model A77 is calling for dehumidification. The dehumidifier will turn off when the RH measured by the Model A77 drops 3% RH below the setting.

MAINTENANCE

CLEAN OR REPLACE THE AIR FILTER

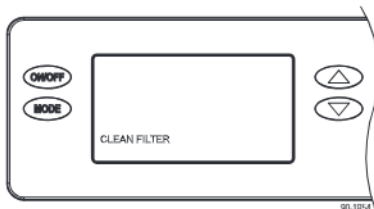

After initial installation the air filter should be checked and cleaned every 3 months. The CLEAN FILTER service reminder will display on the on-board control screen every 3 months. To clear the service message, press the ▲ and ▼ buttons simultaneously for 3 seconds.

FILTER CLEANING PROCEDURE

1. At the UI control, select the **ON/OFF** button and switch to OFF mode.
2. Remove the filter access door from either side of the dehumidifier.
3. Slide the filter out of the dehumidifier.
4. Flush the filter with warm water and a mild detergent solution.
5. Shake off the excess water from the filter.
6. When inserting the filter, making sure the filter is secured in the top and bottom filter rails. Safety clips are located along the filter frame and will compress within the filter frame as the filter is installed. If filter doesn't insert completely check for presence and proper placement of drain insert (see page 12).
7. Replace the filter access door.
8. At the UI control, select the **ON/OFF** button and switch to ON mode.
9. Press the ▲ and ▼ buttons simultaneously for 3 seconds to clear the service message.

DRAIN AND DRAIN INSERT INSPECTION

The drain and drain insert should be checked annually to ensure there are no blockages or air lock in the drain system.

IMPORTANT

The drain insert is a critical feature of the dehumidifier drain management system. This component is required for the dehumidifier to run properly. If the drain insert is not installed, you will not be able to reinstall the air filter. The air filter is equipped with a safety mechanism that prevents you from fully inserting the filter without the drain insert installed.

⚠ WARNING

Running the dehumidifier without the drain insert can lead to condensate leaks.

REMOVING THE DRAIN INSERT

1. Turn the **ON/OFF** switch OFF.
2. Remove the filter access door from the drain side of the dehumidifier.
3. Remove the filter from the dehumidifier to access the drain insert.
4. Locate the drain insert which is located over the drain opening.
5. Remove the drain insert by hooking your finger into the finger loop and gently lifting the cover up and out of the drain pan.
6. Clean the drain insert with warm water and mild detergent solution.

REINSTALLING THE DRAIN INSERT

1. Reinstall the drain insert by inserting your forefinger into the finger loop and grasping the outer edge of the finger loop with your thumb.
2. Gently insert the drain insert tip into the drain opening and tilt the cover downwards into place.
3. Insure the drain insert is seated properly by checking the top surface of the drain cover is the same surface height as the filter guide channel.
4. Turn the **ON/OFF** switch ON.
5. At the UI control, select the **ON/OFF** button and switch to ON mode.

FIGURE 12 – DRAIN INSERT

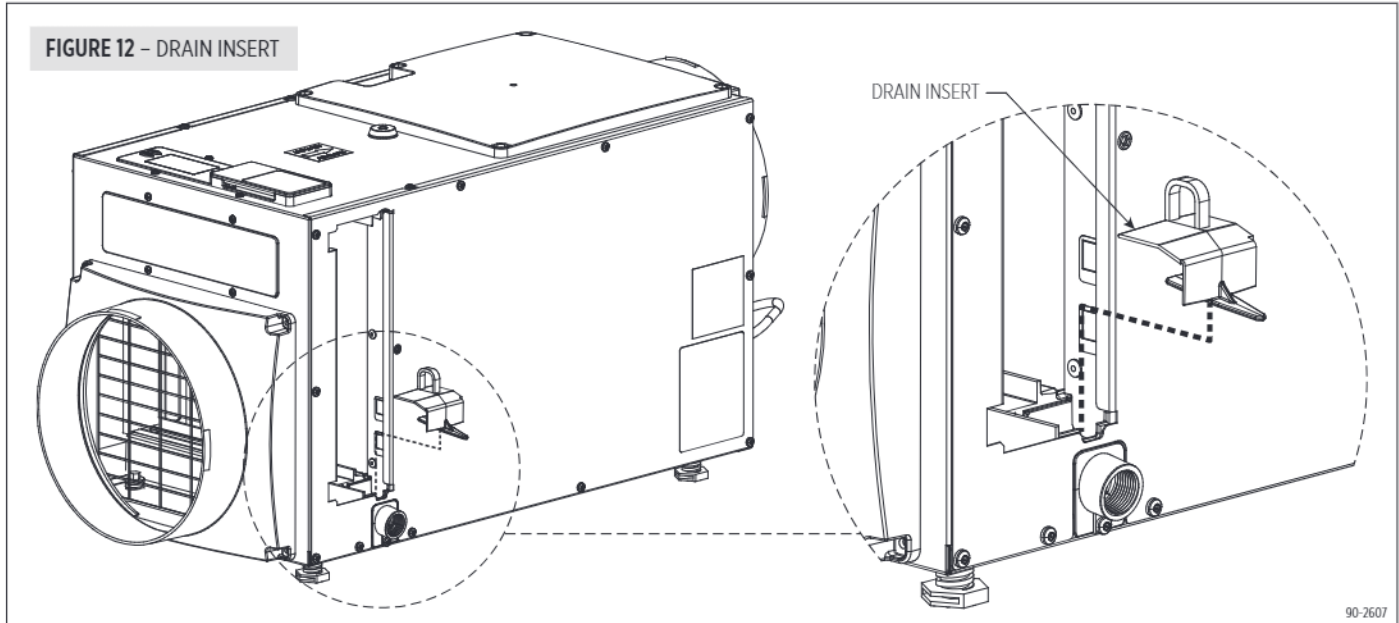

⚠ CAUTION

Do not use spray solvents or cleaners on or near the inlet side of the dehumidifier.
If desired, apply cleaner to a cloth and use to clean the cabinet.

TROUBLESHOOTING

Technical Support is available Monday through Friday, 7:00 a.m. to 5:00 p.m. CST, at (800) 972-3710. Use the guides on the following pages to identify and correct system faults. Contact Technical Support before replacing the unit or any components and for additional troubleshooting.

DIAGNOSTIC CODES

When an error occurs, the Diagnostic Code along with SERVICE REQUIRED will be displayed on the control screen. If a 5818 Alert Light is used, the light will turn on when an error occurs.



TABLE 2 – DIAGNOSTIC CODES

Diagnostic Code	Failure Mode	Action	Reset
E1	Internal Humidity or Temperature Sensor Open or Shorted	<ol style="list-style-type: none"> 1. Cycle power to clear error code. 2. If error code reoccurs replace User Interface, Part No. 71000062. 	Cycle Power
E3	Model A77 Remote Control Communication Loss	<ol style="list-style-type: none"> 1. Check connections between Model A77 and dehumidifier control board. Terminals should be fully inserted and secured in the control board and Model A77 control terminals. 2. If connections are correct and secure, turn off the dehumidifier and remove the Model A77. Use a short section of 4-wire cable to reconnect the Model A77 to the control board. Turn the dehumidifier back on and increase the dryness level setting on the Model A77. If the dehumidifier turns on, the problem is with the wiring between the dehumidifier and control. 3. If the dehumidifier does not turn on, call Technical Support. 	Self-Correcting
E4	Insufficient Capacity	<ol style="list-style-type: none"> 1. Check the frost sensor connection at the power board. Terminal should be fully seated on the power board pins. 2. Remove the side access panel and verify that the sensor is secured to the suction line. 3. If the sensor is connected and secured to the refrigeration line proceed to the next step. 4. Reset the fault by cycling power to the dehumidifier. 5. Turn the humidity setting down (below room humidity level) to make a dehumidification call. 6. Allow the fan and compressor to run for approximately 10-15 minutes and then enter diagnostic test mode by simultaneously pressing the UP ARROW and MODE buttons for 3 seconds. The LCD will display the temperature measured by the internal sensor while also displaying AIR SAMPLING and ON, the humidity measured by the internal sensor while also displaying %RH and ON, and the frost sensor temperature while also displaying ON. Scroll through these values and by using the UP/DOWN arrow buttons. 7. Record values and call Technical Support. 	Cycle Power
E5	High Temperature Thermistor Failure	<ol style="list-style-type: none"> 1. Check the high temperature sensor connection at the power board. Terminal should be fully seated on the power board pins. 2. Remove the side access panel and verify the sensor is not damaged and connected to the refrigeration line coming from the compressor. 3. If the sensor is connected and secured to the refrigeration line, it may need to be replaced with Part No. 71000035 – contact Technical Support to confirm. 	Cycle Power
E6	Low Temperature Thermistor Failure	<ol style="list-style-type: none"> 1. Check the low temperature sensor connection at the power board. 2. Remove the side access panel and verify the sensor is not damaged and connected to the suction line. 3. If the sensor is connected and secured to the refrigeration line, it may need to be replaced with Part No. 71000034 – contact Technical Support to confirm. 	Self-Correcting
E7	Float Switch Open	<ol style="list-style-type: none"> 1. Empty the condensate pan. 2. Check the float switch connection at the control board. 3. If not using a float switch, verify jumper is between float switch terminals on dehumidifier control board. 4. If the problem persists, replace the float switch. 	Self-Correcting
E8	Inlet Air Temperature Out of 50°F – 104°F range or dew point below 40°F	<ol style="list-style-type: none"> 1. Verify all ductwork is properly sealed. 2. If no signs of leak points, contact Technical Support. 	Self-Correcting

TABLE 3 – TROUBLESHOOTING GUIDE

Symptom	Possible Reason	Troubleshooting Procedure
Dehumidifier does not turn on/run.	No power to unit.	<ul style="list-style-type: none"> • Check that the dehumidifier is plugged in. • Check that the power switch is turned ON. • Check that the control is turned ON. • Check that the circuit breaker has not tripped.
Dehumidifier blower is running but with little or no airflow.	Pressure drop across dehumidifier is too high.	<ul style="list-style-type: none"> • Check dehumidifier air filter and replace if necessary. • Check for blocked duct work and clear.
Dehumidifier blower is running but compressor is not.	Float switch open.	<ul style="list-style-type: none"> • If float switch installed, check connections at control board and empty condensate pan. • If no float switch installed check that the jumper is installed at the float switch terminals on the control board.
	Coil frosting – defrost.	<ul style="list-style-type: none"> • Lack of or reduced airflow. Check dehumidifier air filter and replace if necessary. • Check for blocked duct work. • Inlet air conditions below 60°F. Increase the humidity setting.
	Inlet air temperature is outside of the 50°F – 104°F range or the dew point is below 40°F and there is a demand for dehumidification.	<ul style="list-style-type: none"> • Verify all ductwork is properly sealed.
Dehumidifier is not draining properly.	Drain line blocked or unit not level.	<ul style="list-style-type: none"> • Verify that the unit is level. • Check the drain line blockages and for a continuous downward slope. • Verify presence and condition of drain insert. See MAINTENANCE for cleaning procedure, or replace with part number 71000102 if missing or damaged.
Dehumidifier is producing hot air.	Normal function.	<ul style="list-style-type: none"> • Air is reheated across the condenser coil, resulting in a temperature rise between inlet and outlet, this is normal.

SERVICE PARTS

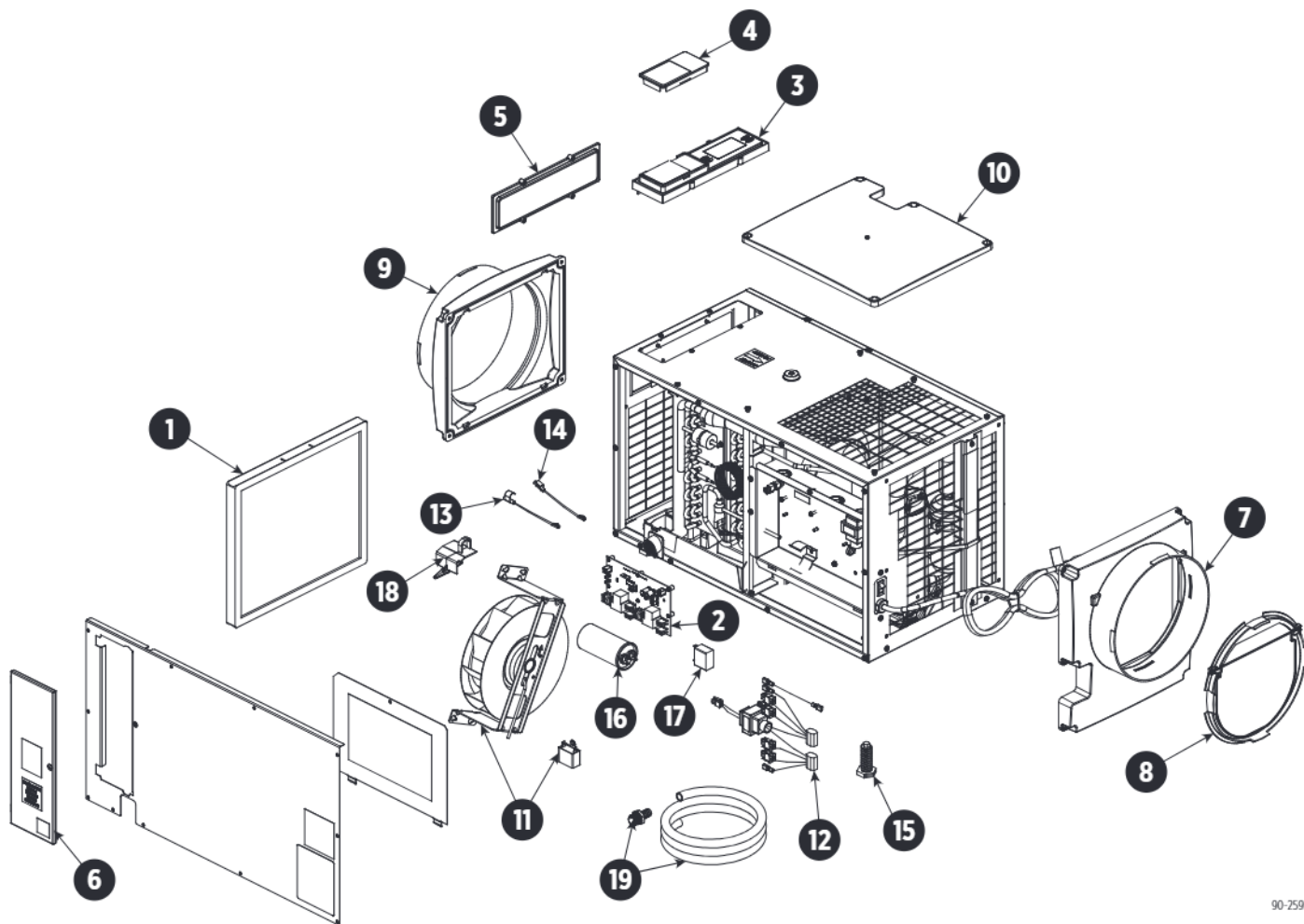

90-2595

No.	Part Description	Part No.
1	Filter, 11.88" x 13.5" x 1", MERV 11	5895
2	Internal Control Board, Deh	71000026
3	User Interface Assembly, Deh	71000062
4	Wiring Access Door, Deh	71000027
5	Hole Cover, UI Ctrl, Deh	71000028
6	Door, Filter Access, Deh	71000100
7	Outlet Duct Panel, Deh	71000029
8	Backflow Damper, 10", Deh	71000030
9	Inlet Duct Panel, Deh	71000031
10	Cover, Outlet, Deh	71000032
11	Fan with 12MFD Capacitor	71000103

No.	Part Description	Part No.
12	Wire Harness, Power, Deh	71000101
13	Sensor, Low Temperature, Deh	71000034
14	Sensor, High Temperature, Deh	71000035
15	Leveling Foot, Deh, A100	71000036
16	Capacitor, Run, 50µF	71000048
17	Capacitor, 12MFD, 450VAC	71000039
18	Drain Insert	71000102
19	Drain Tube + Fitting	71000052
Not Shown		
Condensate Pump with Tubing		A4856
Alert Light		71000087

LIMITED WARRANTY

Your Research Products Corporation Anden™ Dehumidifier is expressly warranted for five (5) years from date of installation to be free from defects in materials or workmanship.

Research Products Corporation's exclusive obligation under this warranty shall be to supply, without charge, a replacement for any component which is found to be defective within such five (5) year period and which is returned not later than thirty (30) days after said five (5) year period by you to either your original supplier or to Research Products Corporation, Madison, Wisconsin 53701, together with the model number and installation date of the dehumidifier.

THIS WARRANTY SHALL NOT OBLIGATE RESEARCH PRODUCTS CORPORATION FOR ANY LABOR COSTS AND SHALL NOT APPLY TO DEFECTS IN WORKMANSHIP OR MATERIALS FURNISHED BY YOUR INSTALLER AS CONTRASTED TO DEFECTS IN THE DEHUMIDIFIER ITSELF.

IMPLIED WARRANTIES OF MERCHANTABILITY OR FITNESS FOR A PARTICULAR PURPOSE SHALL BE LIMITED IN DURATION TO THE AFORESAID FIVE YEAR PERIOD. RESEARCH PRODUCTS CORPORATION'S LIABILITY FOR INCIDENTAL OR CONSEQUENTIAL DAMAGES, OTHER THAN DAMAGES FOR PERSONAL INJURIES, RESULTING FROM ANY BREACH OF THE AFORESAID IMPLIED WARRANTIES OR THE ABOVE LIMITED WARRANTY IS EXPRESSLY EXCLUDED. THIS LIMITED WARRANTY IS VOID IF DEFECT(S) RESULT FROM FAILURE TO HAVE THIS UNIT INSTALLED BY A QUALIFIED HEATING AND AIR CONDITIONING CONTRACTOR. IF THE LIMITED WARRANTY IS VOID DUE TO FAILURE TO USE A QUALIFIED CONTRACTOR, ALL DISCLAIMERS OF IMPLIED WARRANTIES SHALL BE EFFECTIVE UPON INSTALLATION.

Some states do not allow limitations on how long an implied warranty lasts or the exclusion or limitation of incidental or consequential damages so the above exclusion or limitations may not apply to you.

This warranty gives you specific legal rights and you may also have other rights which vary from state to state.

WARRANTY REGISTRATION

Visit us online at anden.com to register your Anden product. If you do not have online access, please mail a postcard with your name, address, phone number, email address, product purchased, model number, date of purchase, and dealer name and address to: Research Products Corporation, P.O. Box 1467, Madison, WI 53701.

Your warranty registration information will not be sold or shared outside of this company.