



USER GUIDE

INTRODUCTION

Thank you for purchasing the Mobius M108S Trimmer, the world's best cannabis and hemp trimmer. When properly configured and operating within design specifications, this industrial agricultural material processing machine offers unrivaled output and a finished product almost indistinguishable from hand-trim.

The information available in this guide will provide you with a thorough understanding of how to safely use this device to maximum effect. Please heed all safety warnings and instructions as they are critical for safe and effective use of the equipment. The M108S is a significant step forward in trimming technology and may operate differently than you are accustomed to. Following the instructions in this guide will allow you to benefit from these innovations.

If you have any questions or encounter topics not covered in this guide, please feel free to reach out to your location of purchase, or Mobius directly. Should you want additional, one-on-one training or to certify a Mobius Lead Operator, please reach out to Mobius directly for information on training services. Mobius also offers consulting services for automation integration and for setting up the ideal trim room, along with accessories for cleaning and component storage for your M108S.

We hope you enjoy your trimming experience with the M108S. Happy trimming!

NOTES:

This User Guide is a comprehensive manual covering the operation and maintenance of the MOBIUS M108S TRIMMER processing machine as of the date of publication. ETEROS TECHNOLOGIES reserves the right to make updates to the machine from time to time. In the event of an update, this User Guide will remain appropriate for the safe operation and maintenance of your unit. This User Guide, as well as any documentation supplied by component manufacturers, are to be considered the information package associated with this device. Every operator must read and understand the User Guide. The manual should be located within easy access for periodic review.

For the most up to date version of this manual, please refer to the manufacturer's website at mobiustrimmer.com

TABLE OF CONTENTS

SAFETY	4
SAFETY INSTRUCTIONS	5
DISCLAIMER	5
WARNING LABELS	6
SERVICE & REPAIRS	6
GENERAL SAFETY PRECAUTIONS	7
MACHINE OVERVIEW	8
M108S	9
AIRTHREAD TENSION TUMBLER	10
TRIFLEX BLADE SYSTEM	10
VARIABLE SYSTEM CONTROL	11
WHAT'S IN THE CRATE	11
SETUP	12
UNCRATING.....	13
REASSEMBLY	15
CONVEYOR SETUP.....	19
TANDEM SETUP	21
OPERATION	22
OPERATION PREP	23
GENERAL OPERATION	23
HOT SWAPS	26
WET TRIMMING	27
DRY TRIMMING	28
TIPS & TRICKS	29
GENERAL	31
CLEANING	32
PREVENTATIVE MAINTENANCE	32
EXPECTED SERVICE LIFE OF STANDARD WEAR PARTS	34
WARRANTY	35
SPECIFICATIONS	36
APPENDICES	37

SAFETY

SAFETY INSTRUCTIONS

To ensure operator safety while in use, this device includes decaling, guarding, and other safety features. Operators are encouraged to use caution and best judgment when using equipment. Equipment should be serviced when required.

To avoid possible damage to the machine and risk of injury to the operator, consult with an ETEROS TECHNOLOGIES representative to answer any questions.

This document refers to the ETEROS TECHNOLOGIES product trimming machine as the M108S. Since this machine has moving blade components, special safety precautions must be observed to reduce the risk of personal injury. Careless or improper use may cause serious or even fatal injury. Please read and understand these precautions thoroughly before using the machine.

All operators must read and understand this User Guide and be trained in safe operation and use of the M108S. We recommend the owner of this equipment develop a standard operating procedure specific to each worksite to address any local hazards or other conditions not outlined in this User Guide. The M108S must be inspected regularly for damage, component failure, and wear. Results of inspection activity should be documented.

ETEROS TECHNOLOGIES makes every effort to ensure the M108S is compliant with all current safety standards. It is the responsibility of the owner to ensure all municipal, provincial, state, county, territorial, and federal codes, regulations and standards have been met in each working location. Do not lend or rent your machine without providing the User Guide. A first-time operator should receive practical instruction before using the machine.

This machine is not to be used for any purpose other than those expressly stated in the User Guide, advertising literature, or other ETEROS TECHNOLOGIES written material pertaining to the M108S.

Operators must be in good physical condition and mental health to operate this device. Under no circumstances should the device be operated by anyone under the influence of any substance, including drugs or alcohol, which might impair vision, dexterity, or judgment. Do not operate the M108S when fatigued. Be alert. If tired while operating the device, take a break. Fatigue may result in loss of control. Working with any equipment can be strenuous. If you have any condition that might be aggravated by strenuous work, check with your doctor before operating the device.

DISCLAIMER

ETEROS TECHNOLOGIES recognizes that the M108S is a purpose-built machine for processing cannabis and hemp by licensed producers. Please check all municipal, provincial/state, and federal laws and regulations before using the M108S. ETEROS TECHNOLOGIES does not promote or condone the use of processing equipment in any way that may be deemed illegal.

It is not the responsibility of ETEROS TECHNOLOGIES to confirm alternative equipment applications.

WARNING LABELS

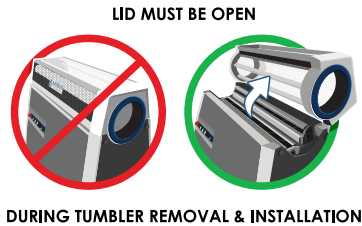

SERVICE & REPAIRS

Minor repairs may be carried out by the end-user under the guidance of Eteros Technologies. Any other repair work may only be carried out by Eteros Technologies or a designated authorized agent (service technician).

Should the need arise, please notify:

ETEROS TECHNOLOGIES
17665 66A AVE. UNIT 202
SURREY, B.C. V3S 2A7
1-866-874-6244

Improper interfacing, improper repair, or unauthorized modification could result in void warranty claims.

GENERAL SAFETY PRECAUTIONS

1. READ and become familiar with the entire User Guide. LEARN the equipment applications, limitations, and possible hazards.
2. KEEP GUARDS IN PLACE and in working order.
3. DO NOT USE THE DEVICE IN A DANGEROUS ENVIRONMENT or damp or wet locations. Never expose control panel directly to rain or water. Keep work area well illuminated.
4. DO NOT use the device in the presence of flammable liquids or gases.
5. KEEP WORK AREA CLEAN. Cluttered areas and workspaces invite accidents.
6. KEEP CHILDREN and BYSTANDERS AWAY from the device. Visitors should be kept at a safe distance from the work area.
7. DON'T FORCE THE EQUIPMENT. It will operate optimally and safely at the rate for which it was designed.
8. USE THE RIGHT TOOL. Don't force the device to do a job for which it was not designed.
9. ALWAYS WEAR EYE PROTECTION when the equipment is operational or when maintaining the equipment.
10. ALWAYS WEAR EAR PROTECTION when the equipment is operational.
11. WEAR PROPER APPAREL. Do not wear loose clothing, gloves, neckties, rings, bracelets, or other jewelry which may get caught in moving parts. Non-slip footwear is recommended. Wear protective hair covering to contain long hair.
12. POWER DOWN AND DISCONNECT EQUIPMENT before servicing and when changing accessories, such as tumbler, blades, etc.
13. INSPECT MACHINE AND REMOVABLE PARTS PRIOR TO OPERATION. The equipment should be inspected prior to use to ensure proper operation in performing its intended function. Check for damage, alignment of moving parts, binding of moving parts, breakage of parts, mounting, and any other conditions that may affect its operation. Any damaged part including guards should be properly repaired or replaced. Ensure that electrical box filter is in place and clean.
14. ALWAYS OPERATE DEVICE IN A WELL-VENTILATED AREA. Dust generated from certain materials can be a health hazard. Use a dust collection system whenever possible. If dust extraction is not installed, a face or dust mask should be worn.

MACHINE OVERVIEW

MOBIUS M108S TRIMMER

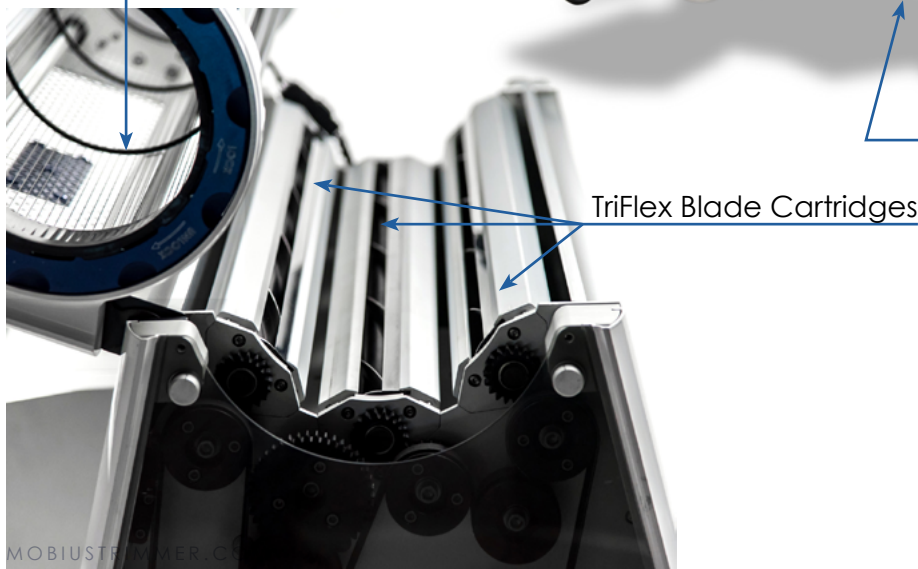

AIRTHREAD TENSION TUMBLER

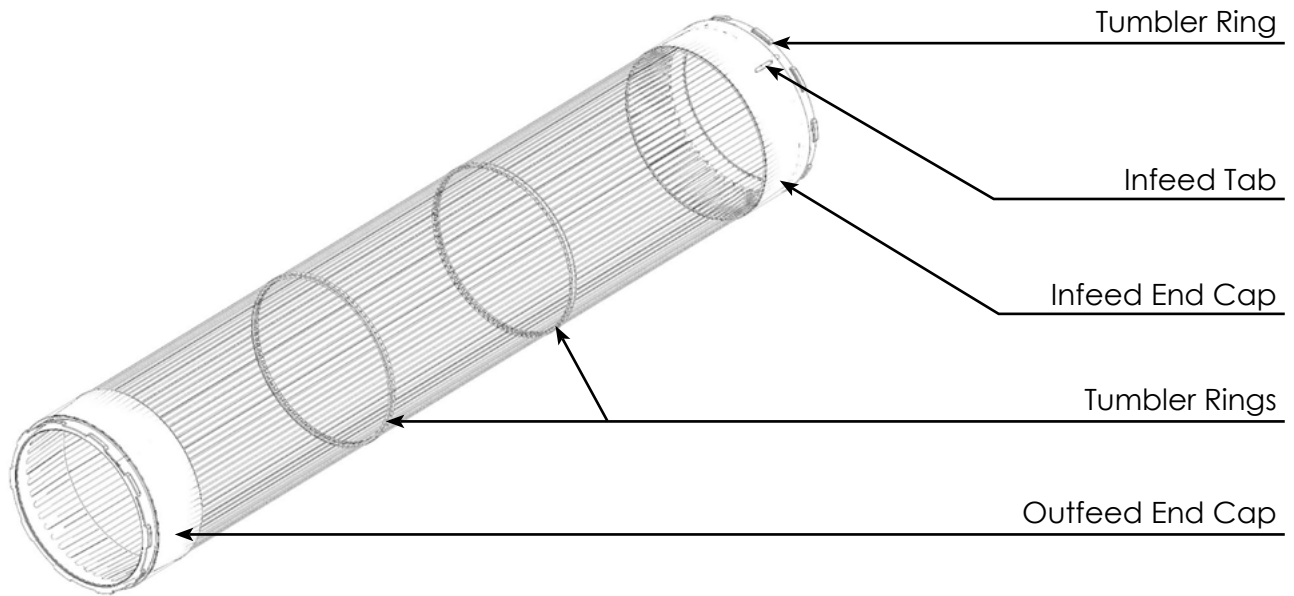

TRIFLEX BLADE SYSTEM

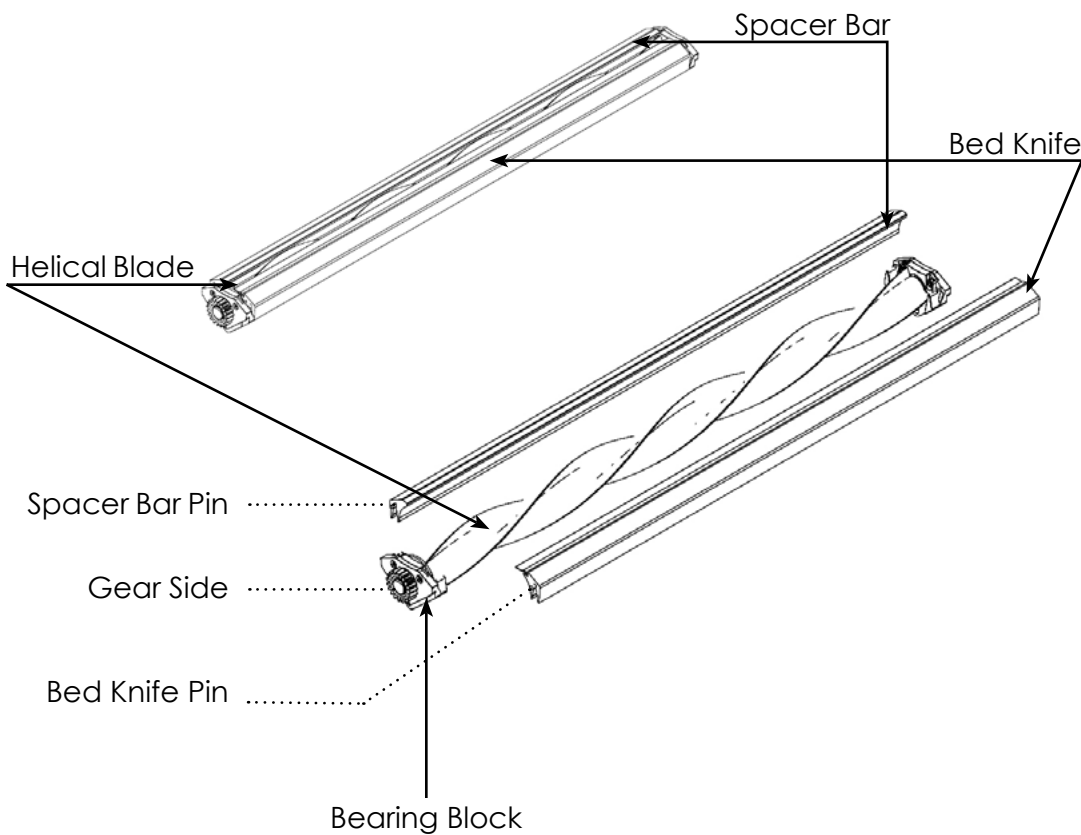

END VIEWS:

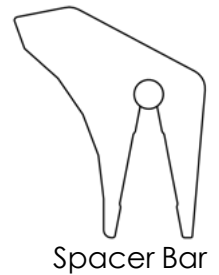

VARIABLE FUNCTION SYSTEM



WHAT'S IN THE CRATE

Your MOBIUS M108S TRIMMER comes with the following items:

- POWER CORD
- 1 SPRING JACK TOOL to install and remove the tumbler
- 2 AIRTHREAD TENSION TUMBLERS
- 2 TRIM TOTES
- 1 FAN HOUSING FILTER BAG
- 2 REPLACEMENT E-BOX FILTERS
- 2 BLUE TUMBLER RETAINING RINGS
- INSTRUCTIONAL POSTERS: 6-Point Blade Inspection, Tumbler Inspection, E-box Filter Installation Tumbler Installation.
- A PAIR OF TANDEM LOCKS (if you plan to run 2 machines together).
- A PAIR OF BLACK OVERRIDE PUCKS (if you plan to use conveyors instead of the hopper and chute).
- 1 INFEED HOPPER and 1 OUTPUT CHUTE (US VERSION ONLY)

SET-UP

UNCRATING

To remove the body of the Mobius from the crate base, you'll want to disassemble a portion of the machine to decrease the weight before lifting it.

To do so, please follow these steps. For a video showing the following process, please refer to the [Uncrating video in our Mobius Academy](#).

UNPACKING THE MOBIUS TRIMMER:



1. Remove the crate lid and 1 side panel



2. Remove 2 boxes containing the hopper and chute, set aside



3. Remove 3 remaining side panels



4. Remove protective plastic from M108S and retain for future use



5. Remove blue plastic wrap holding additional components to the body of the machine (Spring Jack Tool, and extra Trim Tote)



6. Place foam sheet on ground to be used as a protective barrier for other removed components

REMOVING COMPONENTS TO REDUCE WEIGHT:



7. Pull up on levers holding the installed trim tote and rotate them downwards



8. Slide trim tote out and set aside



9. Push down 'hockey stick' lever to unlock the separator and slide the separator out until a hand-sized gap is visible



10. Place hand in the gap to support the weight of the separator and pull it the rest of the way out Place separator on foam sheet



11. Slide fan housing off pegs and remove from the body. Place it on the foam sheet with the separator.

REMOVING LID:



12. Open lid by sliding the 2 latches towards each other, and then rotating the lid away from you



13. Disconnect the wire between the lid and the M108S body



14. With two people, slowly rotate the lid towards the closed position while pulling up on it. When the hinges reach the correct position, the lid will release from the machine body. Place the lid aside.

For more in depth instructions, see the [Academy video on lid removal](#).

REMOVING BLADE CARTRIDGES:



15. Lift each bed knife out of machine and place to the side, preferably in a Mobius Blade Rack



16. Lift each spacer bar out of machine and place to the side, preferably in a Mobius Blade Rack



17. Lift each helical blade out of machine and place to the side, preferably in a Mobius Blade Rack

REMOVING MOBIUS TRIMMER BODY FROM CRATE BASE:



18. Rotate wheels outward and unlock casters



19. Remove the four retaining straps that anchor the machine to the crate base. Rotate the handles on each side of the M108S outward.

Note: 4 people should lift the M108S off the crate base with 1 person per handle



20. Lift the machine straight up to clear the wooden anchor below each wheel. Walk the machine to the side until it clears the crate-base. Set machine down and re-lock the wheels. Remove power cord from crate base

REASSEMBLY

Once the machine has been removed from the base, you can start to reassemble it to get ready for trimming. [View the video online](#), or follow along below. Please do so in the following order:

INSERTING THE BLADE CARTRIDGES

Note: Gloves should be worn when handling the helical blades and any sharp objects

Note: The helical blade must be placed in the machine in the correct orientation. One side of each helical blade has a gear that corresponds to a gear on the outfeed side of the machine.

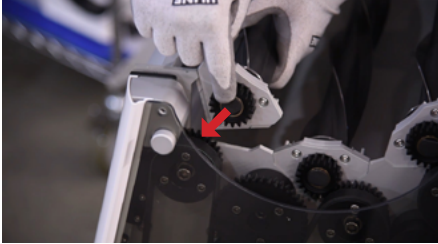

1. Place each helical blade into its housing in the correct orientation (gear on blade interlocks with gear on machine)

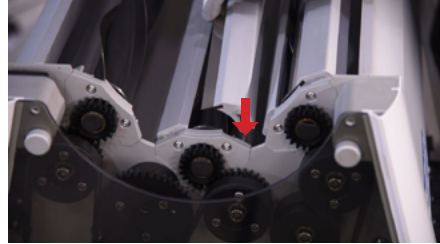

2. **Note:** The spacer bar sits on the far side of the helical blade, and the bed knife sits on the near side. Spacer bars and bed knives must be placed into the machine in the correct orientation. Each has a pin on one side that corresponds with the outfeed side (gear side) of the machine. Slide each bed knife and spacer bar into place around the helical blades

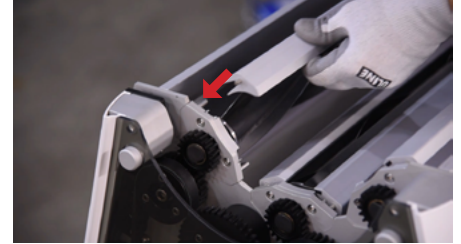

INSTALLING THE LID

[View the video online](#), or follow along below. Please do so in the following order:



3. Place the lid hinge on the body hinge and slowly rotate the lid toward the front of the machine in the closing motion. As the lid closes, it will slide forward into the body hinge. Slowly rotate the lid toward the open position and the lid will lock in the rest of the way.



4. Reconnect the lid wire to the M108S body. Close the lid.

INSTALLING THE FAN HOUSING AND SEPARATOR

[View the video online](#), or follow along below. Please do so in the following order:



5. The fan housing fits into the body by resting on 2 pegs. Holes in the fan housing correspond to the pegs on the body. Align the holes to the pegs and slide the fan housing into place. Ensure the housing sits flush against the body to allow the separator to fit without binding against it.

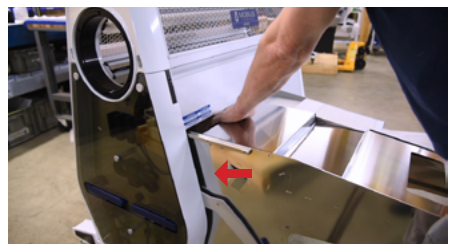
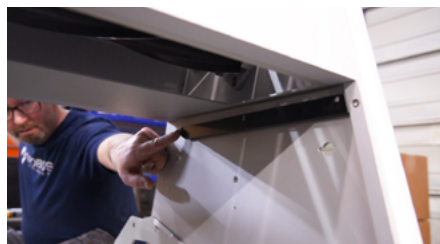

6. **Note:** The separator mates to the machine resting on a guide rail inside the frame. Grip the separator from the opening and the rear (trim tote side) of the housing. Align the separator so it is above the rail on the machine and push it in along the rail. When the weight of the separator is carried by the rail, let go of the opening and slide it the rest of the way into the machine.



7. Pull up the hockey stick lever until the top of the stick is flush with the top of the separator to lock it in place



8. With the Trim Tote gasket seam facing in, slide the Trim Tote onto the rails of the separator



9. Swivel the latches forward and up to seal the gasket and lock the trim tote in place

ADDITIONAL COMPONENTS

Inside the second Trim Tote you will find:



2 AirThread Tension Tumblers



1 fan housing filter bag



2 replacement E-box filters



2 blue tumbler retaining rings



If you plan to run the M108S in tandem, you'll receive 2 tandem locks used to link the 2 machines together.



Black override pucks are included if you plan to use conveyors instead of the hopper and chute.

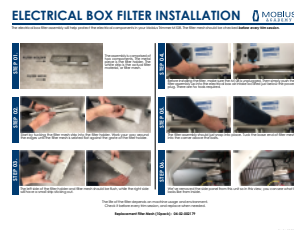

E-box Filter Installation Guide



Tumbler Installation Guide

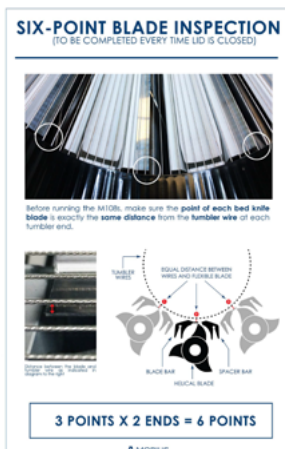

6-Point Blade Inspection Poster



Tumbler Inspection Poster

INSTALLING THE AIRTHREAD TENSION TUMBLER

[View a video of this installation](#), or follow along below:



10. With the lid in the closed position, remove the front screen by sliding the left latch on the underside of the lid to the right while pulling the left side of the screen out



11. Remove the brush by pulling it out of its holders and set it aside



12. Remove the tumbler from the box and take it out of the bag. Retain the bag for storage if there will be long periods of time between trim sessions)



13. Lock the casters and open the lid. **Note:** One side of the tumbler end cap has a small black plastic 'tab' that corresponds to a groove on the infeed side of the lid. The other side is smooth.



14. Insert the smooth side into the infeed side of the lid. Slide the tumbler through the lid making sure the plastic tab lines up with the groove.



15. On the infeed side of the machine, attach the blue tumbler retaining ring by sliding over the edge of the tumbler endcap and twisting it counter clockwise to the lock position. **Note:** If silver is visible on the tabs of the tumbler retaining ring, it is not in the locked position

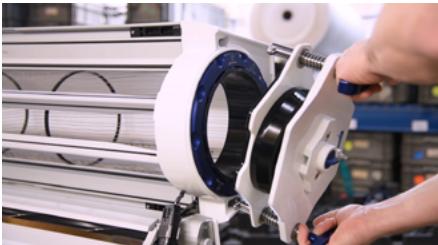

16. Unpack the Spring Jack Tool and insert the handlebars into the receptacles on the infeed side of the lid



17. Leaning in with your weight, turn the handles inward to lock the Spring Jack in place

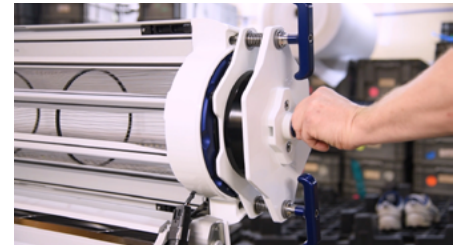

18. Turn the air-release valve on the Spring Jack to the closed position (the handles and the air-release valve should be in a straight line)



19. Attach an air hose to the Schrader valve on the Spring Jack and pressurize to 80 PSI.

Note 1: A hand-pump is supplied with the Spring Jack, but compressed air can also be used.

Note 2: Do not over inflate the Spring Jack. 100 PSI or more can damage the unit



20. Lock on the outfeed tumbler retaining ring on the opposite side of the lid from the Spring Jack tool. The recommended procedure is to grip the inside of the tumbler with your fingers, pull it forward, and rotate the retaining ring with your thumbs. An improperly installed tumbler retaining ring can result in operator injury or damage to the tumbler.



21. Straighten the tumbler cables as much as possible

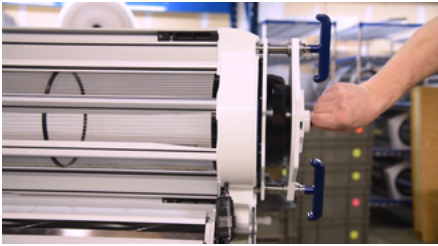

22. Turn the Spring Jack air-release valve to the open position to release the air and apply tension to the tumbler (cables of the tumbler will pull tight)

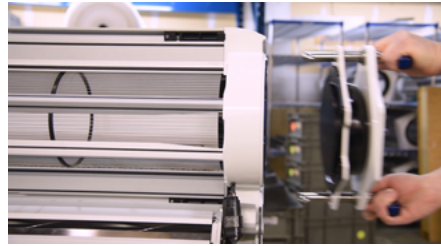

23. Rotate the Spring Jack handles outwards to detach it from the lid. Inspect the retaining rings to ensure they are in the fully locked position. Inspect the tumbler to ensure it is under tension and can rotate freely and that the cables are straight. Close the lid



24. Install the brush by pushing it into the receptacles on either side of the lid (both sides are identical to facilitate installation in either orientation). Re-install the front hex screen

PERFORM THE 6-POINT BLADE INSPECTION

The M108S is ready for safe operation when all blades are fully seated in their channel. The 6-Point Blade Inspection is confirming proper alignment for the 3 blade cartridges on both sides of the machine. Improper alignment can cause damage to the tumbler or blades during operation. [View a video of this inspection](#), or follow along below. You can also [download an inspection poster](#).

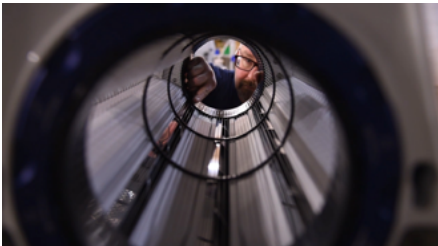

- With the lid closed, check to ensure the gap between the tumbler wire and each bed knife is the same
- To fix a bed knife that is not properly aligned in its channel, open the lid, remove the affected blade, and reinsert it ensuring it fully slides into place
- Close the lid and re inspect to ensure the gap between the tumbler wire and bed knives is now consistent

INSTALLING THE FAN HOUSING FILTER BAG



25. Remove the Fan Housing Filter Bag from its plastic sleeve.
Note: The top of the filter bag has a metal retaining ring that fits into the fan housing by sitting on a rail.

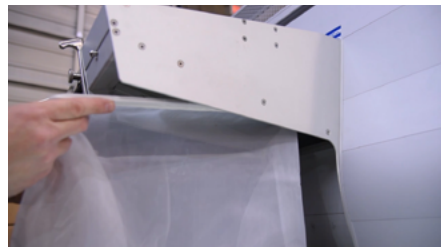

26. Slide the retaining ring up into the housing past the rail and allow it to fall into place



27. Gently tug down on the filter bag to ensure it is seated properly



28. Pull out the rubber power receptacle cover. With the Quality Control decal on the power cord facing up, push the plug into the receptacle on the machine and rotate it clockwise to lock it in place

Note: When plugged in, the machine will power up and the display on the control panel will indicate any errors detected. The lid will also glow red when there is an error.

INSTALLING HOPPER AND CHUTE

Note: The Check Hopper and Check Chute errors will be displayed when they are not installed. The hopper and chute will also be illuminated on the visual indicator at the left of the control panel.



29. The chute attaches to the outfeed side of the machine with the opening pointed downward. Locate the lip on the upper side on the edge that connects to the machine and hook it into the ledge on the lid. Rotate the chute down to connect it to the machine



30. Attach the hopper to the infeed side of the machine in the same way as the chute, with its opening facing up. Hook the lip into the ledge on the lid and rotate the hopper base into place



When chute and hopper are installed properly, these errors will be cleared on the control panel. The red illumination of the lid will turn blue when all errors are cleared, including the release of the E-stop button, indicating the machine is ready to run.

CONVEYOR SETUP

Note: When managing material infeed and outfeed by conveyor, the hopper and chute detection sensors must be bypassed.



1. Attach an override puck to the right rear and left front bearing blocks of the machine to bypass the sensor

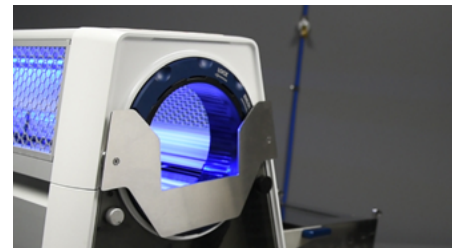

2. Attach conveyor infeed guide to the machine by pushing the pegs into the Spring Jack connection holes

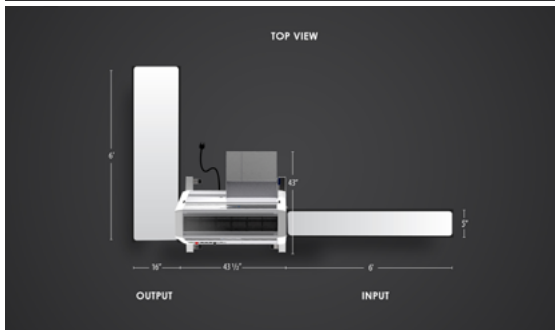
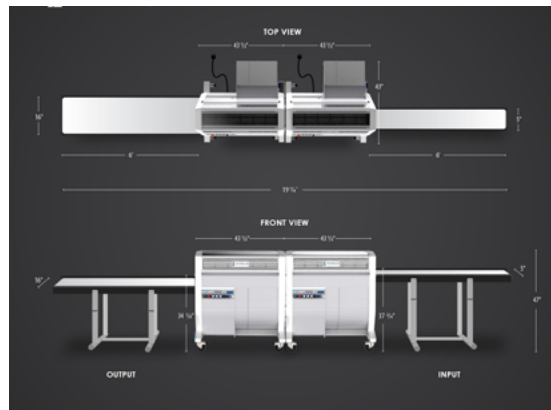

Examples of trimmer and conveyor setups.

OUTFEED CONVEYOR

- Adjust the legs of the outfeed conveyor so that the height of the belt and kick plates are below the outfeed of the trimmer.
- Position the outfeed conveyor adjacent to height to have the belt surface fill the conveyor belt with material prior to turning on either the trimmer or the conveyor.



INFEEED CONVEYOR

1. Ensure the infeed conveyor guide rails are positioned to allow for approximately 2.5" of belt clearance into the tumbler.

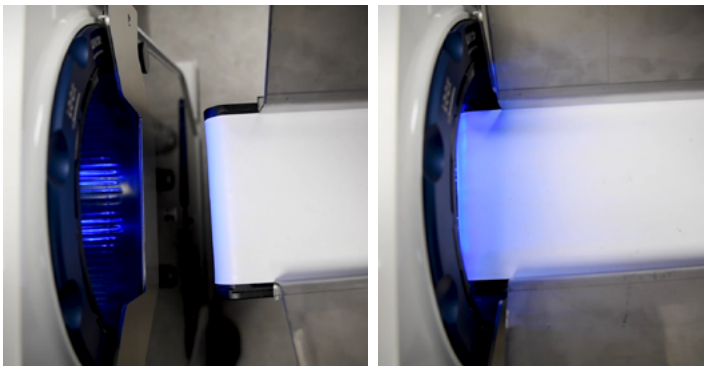

2. Install the Mobius Conveyor Guide onto the trimmer by inserting the guide posts into the receptacles on the lid.

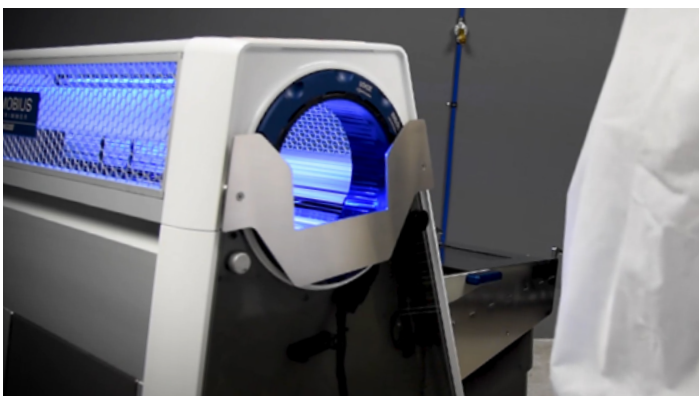

3. Adjust the legs of the infeed conveyor so that the end of the conveyor belt can be inserted into the tumbler and the bottom of the conveyor belt frame is close to or just resting on the Conveyor Guide. It is ok if the lead conveyor legs lift off the floor when the tilt angle is increased.

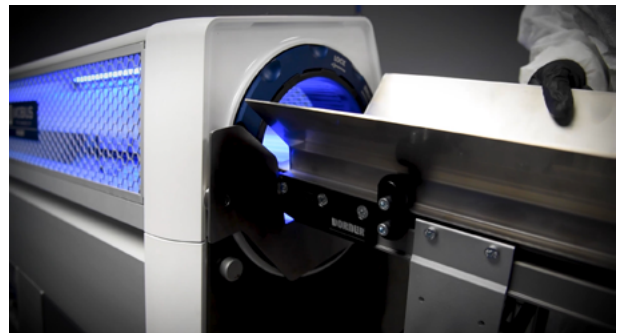

4. Fill the infeed conveyor belt with material in preparation for beginning trimming operations.



TANDEM SETUP

Watch a video of this process in our [Mobius Academy](#), or follow the instructions below:



1. Start by positioning the two units front to back.



2. Remove the conveyor sensor override pucks. Lock the wheels on the outfeed unit and raise it to the full height.



3. Open both lids, and place tandem locks on the outfeed unit conveyor sensors.



4. Move infeed unit and align as close as possible.

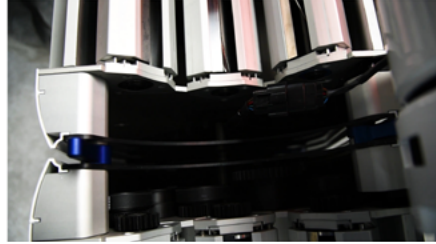

5. Lower outfeed unit until it sits against infeed unit.



6. Lock the wheels on the outfeed unit.

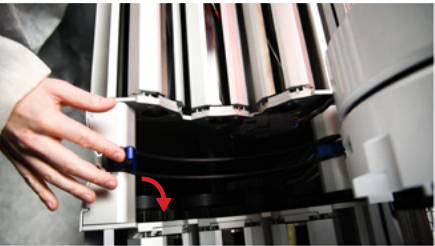

6. Rotate the tandem locks inward until the handles are pointed down.



7. On the control panel of the infeed unit, raise to the desired height.



8. Close the lids, and you're ready to trim.

OPERATION

OPERATION PREP

Please take the following steps to confirm that Mobius M108S Trimmer is ready to operate:

1. Complete a thorough inspection of the blades and tumbler following the 6-Point Blade Inspection steps to ensure that the blades are seated properly.
2. Check that the electrical box filter is in place and clean.
3. Confirm that the power cord is in good condition and locked into the machine power receptacle.
4. Ensure all guarding is properly installed and is in good working condition.
5. Address any errors that are flagged on the control panel.

GENERAL OPERATION

PRIOR TO DEVICE OPERATION, ENSURE ALL GUARDS ARE IN PLACE AND PROPERLY SECURED. PRESS THE E-STOP BUTTON AT ANY TIME TO STOP ALL MOVING PARTS AND TURN OFF THE MACHINE.

GETTING READY TO TRIM

1. Identify a Trim Team Lead. This person is responsible for:
 - Ensuring that the trimmer is set-up correctly and all pre-start inspections have taken place;
 - Ensuring that appropriate PPE is available and utilized by all team members in the room;
 - Assigning trim team roles, as per item 2 below;
 - Operating the trimmer and dialing in the key variables (angle, feed rate and vacuum) until the desired level of trim is reached on the outfeed. *Note, a change to any one of the key variables will take a period of time to show on the output quality
2. Identify roles for each of the trim team members. Typical roles could include:
 - Feeding the trimmer via the infeed conveyor or infeed hopper;
 - Performing QC and polishing of material on the outfeed conveyor or outfeed tote;
 - Acting as a runner, which includes bringing totes of untrimmed material to the infeed line, changing out full totes for empty totes on the outfeed line, keeping an eye on and swapping out the trim tote when full, weighing material, as required, etc.
3. Put the infeed and outfeed equipment into place. If using conveyors, ensure they are adjusted to the correct height. For the outfeed conveyor, this means setting it at a height below the outfeed of the trimmer. For the infeed conveyor, this means setting it at a height that has the belt just touching the infeed conveyor guide when the tilt angle is at the lowest level you will be operating at. It is ok if the lead legs on the infeed conveyor lift off the floor when the tilt angle is increased

4. Ensure there is an adequate amount of prepared material available at the infeed end of the trim line and that is within easy reach of the operator who will be feeding the machine.
5. Ensure there is an empty tote on the outfeed end of the trim line to collect the material.
6. Ensure there is an empty trim tote stationed close to the back of the M108S, near the separator.
7. If using conveyors, put them into place and adjust the trimmer to the approximate angle you expect to be trimming at. For more tips on this, please see the relevant dry and wet trimming sections of this document.
8. Fill the infeed conveyor belt with material in preparation for beginning trimming operations.

MACHINE START UP SEQUENCE

1. Disengage the e-stop button.
2. Press the blue button to turn on the machine. The lights will turn from blue to white indicating the machine is ready to begin trimming.
3. Pull out each of the three buttons that control the VFDs (blades, vacuum, tumbler) and turn the dials to the maximum level (11).

TRIMMING - GENERAL

1. The Mobius M108S performs best when the tumbler is relatively full. Depending on the material, aim to keep the tumbler approximately 3/4 full. See below for more details on specific trimming scenarios.
2. Proper functioning of the vacuum system is critical to overall performance of the M108S. Always ensure that the separator window is installed (sealed into place on aluminum version of the separator), and that the trim tote gasket is in good condition and flush to the separator upon installation. Any compromise of the vacuum system will negatively impact trim quality and throughput and will direct plant material through the impeller and fan housing exhaust.
3. To achieve consistent results, the material being fed into the machine must be consistent. To the degree possible, ensure that all totes of untrimmed material have been prepared to a relatively consistent level (i.e. same amount of fan leaves present, same degree of breakdown of larger flower clusters, etc.).
4. To achieve consistent trimming results, the feed rate to the machine must be consistent. Once your tumbler is filled to the correct capacity and you have dialed in the quality of trim you are seeking, aim to maintain a consistent feed rate for the remainder of the trim session.
5. Assuming that the material has been consistently prepared, there are two key factors that the operator can use to adjust trim quality for wet trimming, and three key factors for dry trimming:

TILT ANGLE: Increasing the tilt angle uses gravity to move the material through the tumbler more quickly. The higher the tilt angle, the looser the trim. The lower the tilt angle, the tighter the trim

FEED RATE: Increasing the feed rate to the machine will move material through the tumbler more quickly. The faster the feed rate, the looser the trim. The slower the feed rate, the tighter the trim.

VACUUM (*dry trim only*): Because dry material is so much lighter than wet material, the vacuum can be used to adjust how long material is held in the tumbler, thus how tightly it is trimmed. Reducing the vacuum will allow material to flow through the tumbler more quickly with a looser trim; increasing the vacuum holds the material in the tumbler longer and tightens the trim. See below for more tips on dry trimming.

6. Once the desired trim quality has been dialed in, the job of the resources on the outfeed is to perform QC on the material. The specific criteria to look for is established by the end-user and could include things like bud size or mold, but with respect to trimming, it is generally grow's feet that the QC line is on the lookout for. As a general rule of thumb, a bud that requires 2 – 3 snips to clean-up should get addressed on the outfeed line; a bud that requires more than that should be set aside in a separate bin for clean-up off the outfeed line or run through the machine a second time. If more than 5% of material is being set aside like this, consider adjusting the machine parameters (tilt angle, feed rate) to tighten up the trim quality.

TUMBLER EMPTY SEQUENCE

At the end of a batch or trim session, there is no longer material being fed into the infeed end of the trimmer to push material through to the outfeed. To ensure that the material at the end of a batch is properly trimmed and exits the tumbler without being over-trimmed, follow these steps:

1. Once the last of the material has been loaded into the tumbler, begin to slowly raise the tilt angle of the machine. If using conveyors, the infeed conveyor can be backed out at this point.
2. Slowly ramp down the vacuum over a period of approximately one minute and then shut off the vacuum and the blades. Leave the tumbler running. If operating in tandem, perform this step on the infeed machine first and then perform this same step on the outfeed machine.
3. Continue running the tumbler until all of the material has exited the machine.

TRIM TOTE CHANGES

Depending on the material being run, the trim tote may fill up every 15 – 25 minutes. Below are the steps to take when changing out the trim tote:

1. Ensure that one of the trim team resources in the room is assigned to keep an eye out for when it is time to change out the trim tote. Note, if the trim tote is allowed to overfill, trimmed material will be forced to bypass the tote and get directed into the impeller and fan housing exhaust.
Always empty the trim tote prior to it becoming completely full.
2. When the trim tote is ready for change out, stop the infeed conveyor (if using), turn off the blades, vacuum and tumbler by pressing in these dials on the control panel, and activate the e-stop switch.
3. Once the trimmer is at a full stop, disengage the trim tote lock levers and pull out the full trim tote.
4. Install an empty trim tote into the separator and engage the trim tote lock levers. Ensure that the trim tote is properly seated and that the trim tote gasket is fully sealed against the separator.
5. To recommence trimming operations, turn on the vacuum first. This will hold the material in the tumbler and prevent it from spilling out the end in a big batch during start-up.
6. Once the vacuum has ramped up to full power (5 – 10 seconds), turn on the blades, tumbler, and, if using them, the infeed and outfeed conveyors.

HOT SWAPS

The Mobius M108S was designed in a way that enables speedy swap-out of all plant-touching components. Depending on the material being run (wet, dry, strain, etc.), the temperature in the room, and a variety of other factors, some or all of these plant touching parts may need to be changed out during a trim session. We call this a 'hot swap'.

Wet trimming a very sticky strain in a warm room may require performing a hot swap after only 90 minutes, while dry trimming in a cool room might not require a hot swap at all, even after six hours. Under normal operating conditions, hot swaps are typically performed every 2 – 4 hours during trimming.

To perform a hot swap, take the following steps:

1. Ensure that one of the trim team resources in the room is assigned to keep an eye out for when it is time to perform a hot swap.
2. When it's time for a hot swap, stop the conveyors (if using them), turn off the blades, vacuum and tumbler by pressing in these dials on the control panel, and activate the e-stop switch.
3. Open the lid of the machine to inspect the tumbler, brush, bed knives, spacer bars and helical blades. Determine what parts require swap-out:
 - Resin tends to build up fastest on the bed knives, so these will likely be changed on every hot swap;
 - If wet trimming, it is a good idea to keep the brush clean. Either swap in a new brush or remove the one in use, run a hand up and down the brush to clear off any plant material stuck in the bristles and reinstall it in the lid.
 - Tumbler, spacer bars and helical blades may or may not need to be swapped out. Assess resin build-up and swap-out these parts as necessary.
 - Since the machine is already at a stop, it is usually a good idea to empty or swap out the trim tote at the point.
4. Once the hot swap is complete, close the lid and perform the [6 Point Blade Inspection](#). Because the machine has been in operation, it is possible for small pieces of plant material to interfere with how the blade cartridge components are seated. Use the 6 Point Blade Inspection to ensure all components are correctly seated.
5. To recommence trimming operations, turn on the vacuum first. This will hold the material in the tumbler and prevent it from spilling out the end in a big batch during start-up.
6. Once the vacuum has ramped up to full power (5 – 10 seconds), turn on the blades, tumbler, and, if using them, the infeed and outfeed conveyors.

WET TRIMMING

SINGLE MOBIUS UNIT

When wet trimming with a single Mobius unit, try starting with the following parameters and adjust as necessary to reach the desired trim quality:

- **VFDs:**
 - Blades: at full power (11)
 - Vacuum: at full power (11)
 - Tumbler: at full power (11)
- **FEED RATE:**

If using conveyors, you will likely run in the range of 10 – 20 on the infeed conveyor speed dial. Adjust up or down as necessary to achieve desired trim quality. If using an infeed hopper, aim to maintain a consistent feed rate once the desired trim quality has been dialed in.
- **TILT ANGLE:**

Start with caster at the infeed end of the line approximately 1/2" off . Over the first few minutes of trimming, play with the tilt angle, only increasing to the point where it does not compromise trim quality below your requirements.
- **TUMBLER FILL:**

When wet trimming, there is no need to rapidly prime the tumbler (unlike dry trimming) but it is important to maintain the tumbler at approximately 3/4 full.

TANDEM MOBIUS LINE

When wet trimming with a tandem Mobius line, try starting with the following parameters and adjust as necessary to reach the desired trim quality

- **VFDs:**
 - Blades: at full power (11)
 - Vacuum: at full power (11)
 - Tumbler: at full power (11)
- **FEED RATE:**

If using conveyors, you will likely run in the range of 20 – 40 on the infeed conveyor speed dial. Adjust up or down as necessary to achieve desired trim quality. Use of an infeed hopper is not recommended for a tandem Mobius set-up as it is difficult to maintain a consistent, high feed rate.
- **TILT ANGLE:**

Start with casters at the infeed end of the line approximately 2" off the floor. Over the first few minutes of trimming, play with the tilt angle, only increasing to the point where it does not compromise trim quality below your requirements.
- **TUMBLER FILL:**

When wet trimming, there is no need to rapidly prime the tumbler (unlike dry trimming) but it is important to maintain the tumbler at approximately 3/4 full.

DRY TRIMMING

SINGLE MOBIUS UNIT

When dry trimming with a single Mobius unit, try starting with the following parameters and adjust as necessary to reach the desired trim quality:

- **VFDs:**
 - Blades: at full power (11)
 - Vacuum: Start at 3/4 power (approximately 7). Once the tumbler is 'primed' (i.e. 3/4 full, increase the vacuum until the desired trim quality is reached)
 - Tumbler: at full power (11)
- **FEED RATE:**

Once the tumbler is primed, you will likely run your infeed conveyor speed somewhere in the range of 15 – 25. Adjust up or down as necessary to achieve desired trim quality. If using an infeed hopper, aim to maintain a consistent feed rate once the tumbler is primed and the desired trim quality has been dialed in.
- **TILT ANGLE:**

Start with casters at the infeed end of the line approximately 1" off the floor. After the tumbler has been primed and the feed rate has been dialed in for trim quality, adjust the tilt angle up or down to maintain the tumbler at 3/4 full
- **TUMBLER FILL:**

'Priming' the tumbler is critical for dry trimming. Priming the tumbler means to fill it as rapidly as possible to 3/4 full. Once the tumbler is 3/4 full, dial back the feed rate as described below.

TANDEM MOBIUS LINE

When dry trimming with a tandem Mobius line, try starting with the following parameters and adjust as necessary to reach the desired trim quality:

- **VFDs:**
 - Blades: at full power (11)
 - Vacuum: Start at 3/4 power (approximately 7). Once the tumbler is 'primed' (i.e. 3/4 full, increase the vacuum until the desired trim quality is reached)
 - Tumbler: at full power (11)
- **FEED RATE:**

Once the tumbler is primed, you will likely run your infeed conveyor speed somewhere in the range of 20 – 45. Adjust up or down as necessary to achieve desired trim quality. If using an infeed hopper, aim to maintain a consistent feed rate once the tumbler is primed and the desired trim quality has been dialed in
- **TILT ANGLE:**

Start with casters at the infeed end of the line approximately 4" off the floor. After the tumbler has been primed and the feed rate has been dialed in for trim quality, adjust the tilt angle up or down to maintain the tumbler at 3/4 full.
- **TUMBLER FILL:**

'Priming' the tumbler is critical for dry trimming. Priming the tumbler means to fill it as rapidly as possible to 3/4 full. Once the tumbler is 3/4 full, dial back the feed rate as described below, but always maintain a 3/4 full tumbler

TIPS & TRICKS

Our team has been into countless facilities all over the world since the release of the Mobius Trimmer and we've learned a lot along the way! Here are the tips & tricks that we use to maximize trimming throughput and quality.

- If dry trimming, aim to have the moisture content of the material in the 12% - 15% range. When the moisture content is lower than 12% the leaves tend to curl into the flower, making it harder to remove the leaf without also shaving away some of the flower. It also makes the plant material more brittle, causing the leaves to break off, instead of being cleanly sheared off.

Don't have a moisture meter on hand? No problem. Here's what you're looking for: you want to be able to roll the bud between your palms and have the leaves come off but the flower to stay intact. That is the perfect time to dry trim.

- Related to the first point, be careful about re-hydrating. If your plant material was dried down to 8% and you've re-hydrated it back up to 13%, there's a chance that the structure of the leaves and stems has been compromised, making it difficult to achieve a clean trim. If you find yourself in this situation, try re-hydrating a small batch first and see if you are able to cleanly pinch off leaves and stems. If so, go ahead with re-hydrating to that level. If not, you may want to consider re-hydrating to a lower level or moving forward with trimming the material as-is.
- Keep your plant material and your trim room as cool as possible. This will better maintain the condition of the plant material and reduce resin build-up on the machine components, hence extending the time between hot swaps. Users should aim to keep their trim environment at 18oC/64oF or lower. The Mobius can be operated in a very wide temperature range, so the limiting factor is generally the facility infrastructure.
- Related to the point above, consider keeping a spray bottle filled with ice water on-hand if you are wet trimming. Giving the tumbler a spritz through the lid screens every 5 – 10 minutes can help reduce resin build-up. Note, the Mobius does not require lubrication – this is simply for the purpose of reducing resin build-up.
- To achieve peak throughputs and consistent trim quality, the following functions should be added to the duties of the Trim Team Lead (or other resource):
 - The infeed conveyor must always be loaded with material, and the loading must be done correctly (i.e. in a single, consistent layer);
 - The amount of time that there is a red light in the lid must be minimized. Brief stops for trim tote changes and hot swaps should be the only reason the machine is not running. If the lid is red, the Trim Team should be immediately on it with the goal of getting up and running again as quickly as possible.
 - The following must be on-hand at all times so as to prevent unnecessary stoppages (see previous bullet):
 - Spare trim totes placed near the back of the trimmer for quick swap-out
 - Empty collection bins placed near the outfeed line for quick swap-out
 - Full bins of material placed near the infeed line so that the infeed conveyor is always full

- The Mobius Trimmer can handle pretty much anything you can throw at it, but what you get out is directly related to what you put in. If you feed material that has been very well prepared, with all of the larger leaves removed, you can expect to perform less clean-up on the outfeed and to achieve a high flower to trim ratio. On the other hand, if the material has not been broken down and a high proportion of the material is larger leaves and stems, you can expect to require more clean-up of crow's feet and a much lower ratio of flower to trim.
- At the beginning of a trim session, the material that comes out of the machine in the first minute or two will not necessarily be trimmed to the level being sought, since the tumbler is just getting filled and the tilt angle and feed rate are getting dialed in. To best manage this, Eteros recommends having two totes available on the outfeed. Over the first few minutes, material is being collected in Tote A on the outfeed; once the desired level of trim is reached, swap in Tote B on the outfeed. The material in Tote A can then be run through the trimmer again or set-aside for touch-up by hand.

In general, our observation is that it is faster overall to spend the time on preparing material upstream of trimming, and this will always yield a higher value (i.e. higher cannabinoid content) trim. Some operations are not structured in a way that allows for this, which is no problem, but the end-user must adjust their throughput and yield forecasts accordingly.

GENERAL

CLEANING

While the body of the Mobius Trimmer cannot be power washed, many of the components can be. Once the removable parts are out of the machine, the body and lid can be washed and wiped as needed. The lid can be wiped down while installed on the body or removed for cleaning. The exterior should never be hosed or sprayed. Evidence of water near the motor, conduit, electrical panel, or gearbox could void the machine warranty.

[Appendix B](#) contains a chart with cleaners and procedures we recommend to ensure your components are optimally maintained and therefore extending the life of your equipment.

PREVENTATIVE MAINTENANCE

NOTE: PERFORM THESE STEPS WITH THE MACHINE UNPLUGGED

PERFORM **BEFORE** EACH USE (MOBIUS LEAD):

1. Check tumbler condition. Ensure wires are not kinked or frayed. Ensure rings and end caps are flush and sealed. Ensure tumbler has been stored properly before use (i.e. that it has been stored in a plastic bag with water).
2. Check trim tote gasket condition. Ensure gasket is not damaged and is securely attached to trim tote all the way around the rim.
3. Check trim tote condition. Trim tote should be rectangular (not bowed or distorted) and should not have any cracks or tears.
4. Check helical blades, bed knives and spacer bars to ensure there is no damage (i.e. no nicks on the cutting edges or gouges on the body of each of these parts). Ensure dowel pin is in place.
5. Check brush to ensure there is no damage to bristles.
6. Ensure a clean e-box filter is installed



PERFORM **AFTER** EACH USE (MOBIUS LEAD):

1. Thoroughly clean all plant-touching parts and place parts in an orientation that ensures that they drain and dry completely.
2. After rinsing the tumbler, store it wet in a plastic bag until next use. This will maintain the flexibility of the tumbler rings and end caps.

PERFORM EVERY 50 HOURS (MAINTENANCE):

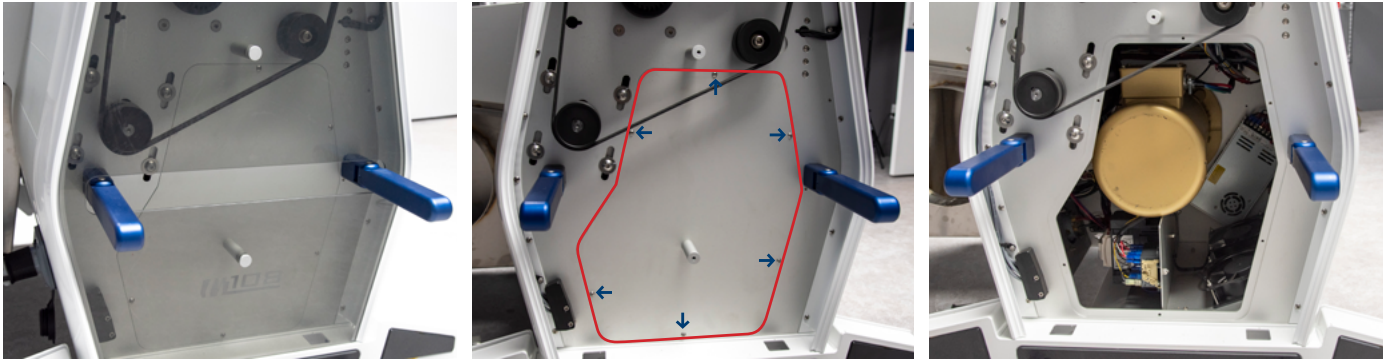

1. Remove dust and other particulate that may have accumulated inside the E-box of the machine. To access this area, remove the 6 screws from the site panel and use compressed air and a vacuum to remove the particulate.
2. Check 'hockey stick' to ensure that it is in good working condition and not bent.
3. Check trim tote engagement levers and rails to ensure that a proper seal is achieved when the trim tote is installed

PERFORM EVERY 150 HOURS (MAINTENANCE):

1. Check condition of gears and pulleys on left side of machine, lid and all helical blades. Ensure there are no significant signs of wear.
2. Check belt tension, aiming for 10 KG tension.
3. Check o-rings on underside of lid to ensure they are in good condition.
4. Review inventory of tumblers, helical blades, bed knives, spacer bars, brushes, trim totes and trim tote gaskets, ensuring that an appropriate number of each part is on-hand and in good working condition.
5. Perform a visual inspection of the impeller to ensure that it is in good condition.

EXPECTED SERVICE LIFE OF STANDARD WEAR PARTS

PART	EXPECTED SERVICE LIFE
E-box Filter	Replace prior to each trim session
Bed Knives	200 hours
Brush	200 hours
Tumblers	200 hours, provided they are properly handled, an infeed conveyor is used and the tumbler washer is employed to clean them
Trim totes and gaskets	Inspect prior to each use and replace as necessary
Spacer bars	1,000 hours
Helical blades	1,000 hours
Belt	1,000 hours
Pulleys/bearings	1,000 hours
Lid	Lid serviced with new bearings at 1,000 hours

WARRANTY

Thank you for purchasing Mobius Trimmer equipment from Eteros Technologies Inc.

The Mobius M108S Trimmer, MBX Bucker, M210 Mill and Mobius Automatic Tumbler and Brush Washer are covered by our manufacturer's warranty as follows:

- No warranty on consumable parts, including blades/blade bars, tumbler, fan housing filter bag, brush-bar, filters, trim tote gasket, die plates, rolls, and screens;
- Warranty coverage for one (1) year or 1,000 operating hours, whichever occurs first, on motors, electrical components, and remainder of machine components.

The warranty period begins on the date the equipment is received by the customer. Any damage that occurs during shipping will be the responsibility of Eteros Technologies.

The above terms are valid if Mobius equipment is used and maintained as directed. If the equipment is modified in any way, all terms of this warranty are void. This warranty does not apply to cosmetic damage, such as scratches or general wear and tear.

Should you experience a technical problem with your Mobius equipment, please contact the manufacturer at 1-866-874-6244.

ETEROS TECHNOLOGIES INC. WEST
17665 66A AVE. UNIT 202
SURREY, BC V3S 2A7

ETEROS TECHNOLOGIES INC. EAST
130 INDUSTRIAL AVE. UNIT 502
CARLETON PLACE, ON K7C 3C4

SPECIFICATIONS

Wet / Dry Capable	Yes
Construction	Anodized aluminum & 304 Stainless Steel
Speed Adjustments	1 - 11
Number of Blades	3
Blade Treatment	Nitrided
Power Requirements	3 Phase, 208 V, 30 Amps OR Single Phase, 240V, 35 Amps
Vacuum Motor	5HP
Tumbler Motor	1/8 HP
Cutter Motor	3/4 HP
Tool-less Disassembly	Yes
Tandem Ready	Yes
Integrated Tilt Angle	Yes
Fits Through a 32" Door	Yes
Tumbler Diameter	8"
Tumbler Length	36"
Width	43"
Length	43.5"
Length (with shrouds in place)	77.5"
Height	47"
Weight	450lbs
Warranty	1 Year
Certifications	ETL (CSA & UL Equivalent)







APPENDIX A





HOT SWAP KIT

HOT SWAP KIT

PART DESCRIPTIONS & INTENDED USES



PART NUMBER	DESCRIPTION	QUANTITY	APPLICATION / USE	PICTURE
00-01-002116	AIRTHREAD TENSION TUMBLER	2	CRADLES FLOWER DURING TRIMMING AND FACILITATES BLADE ACCESS. PLANT-TOUCHING COMPONENT TO BE REPLACED DURING A HOT SWAP.	
00-01-000512	HELICAL BLADE ASSEMBLY	3	AS REQUIRED TO HOT SWAP 1 M108S. PLANT-TOUCHING COMPONENT TO BE REPLACED DURING A HOT SWAP.	
00-01-000583	BED KNIFE ASSEMBLY	3	BOX OF 3 KNIVES AS REQUIRED TO HOT SWAP 1 M108S. PLANT-TOUCHING COMPONENT TO BE REPLACED DURING A HOT SWAP.	
00-01-000587	SPACER BAR	3	BOX OF 3 BARS AS REQUIRED TO HOT SWAP 1 M108S. PLANT-TOUCHING COMPONENT TO BE REPLACED DURING A HOT SWAP.	
00-01-002327	TRIM TOTE WITH GASKET	2	TRIM RECEPTACLE COMPONENT OF INTEGRATED SEPARATOR SYSTEM. PLANT-TOUCHING COMPONENT TO BE REPLACED DURING A HOT SWAP.	
00-01-000510	BRUSH ASSEMBLY	1	ENSURES FLOWER FLOW IN TUMBLER. PLANT-TOUCHING COMPONENT TO BE REPLACED DURING A HOT SWAP.	

PART NUMBER	DESCRIPTION	QUANTITY	APPLICATION / USE	PICTURE
04-02-002179	ELECTRICAL BOX FILTER MESH 10-PACK	2	PARTICULATE SCREEN TO BE REPLACED AS REQUIRED. SHOULD BE CHECKED REGULARLY.	
00-02-001817	SOAK 'N' STORE TUBS	3	MULTI-PURPOSE TUB FOR CLEANING AND STORAGE. ACCOMMODATES BLADE STORAGE RACKS.	
00-06-001996	HELICAL BLADE STORAGE RACK	1	MULTI-PURPOSE RACK THAT ACCOMMODATES UP TO 3 HELICAL BLADES FOR CLEANING, OR 3 FULL BLADE CARTRIDGES FOR STORAGE (3 HELICAL BLADES, 3 BED KNIVES, 3 SPACER BARS).	
00-06-002193	HELICAL BLADE SUPPORT RACK	1	RACK THAT CRADLES 3 HELICAL BLADES TO FACILITATE CLEANING BEARING ENDS, WHICH SHOULD NOT BE SUBMERGED IN CLEANING SOLUTION.	
00-06-001997	BED KNIFE & SPACER BAR RACK	1	STACKABLE RACK FOR SAFE CLEANING AND STORAGE OF 3 BED KNIVES AND 3 SPACER BARS. BED KNIVES CAN BE INSERTED BLADE-UP TO ACCOMMODATE CLEANING. RACK FITS IN SOAK 'N' STORE TUBS AND CAN BE SUBMERGED IN CLEANING SOLUTION.	

APPENDIX B

RECOMMENDED CLEANERS AND PROCEDURES

RECOMMENDED CLEANERS FOR EACH MOBIUS PART:

It is recommended that warm or hot water is used to make up your diluted cleaning solution for the Mobius.

MOBIUS PART	RECOMMENDED PH RANGE OF CLEANER	RECOMMENDED CLEANER(S)	RECOMMENDED CLEANING PROCEDURE
BLADE SYSTEM (Helical Blades, Bed Knives, Spacer Bars)	8.5 – 10	STEP 1 - CLEAN - Tub O' Towels Heavy Duty Cleaning Wipes and/or - RESIN8 XTRA STEP 2 - RINSE with water STEP 3 - SANITIZE, IF NECESSARY - Shyield or Isopropyl	BED KNIVES & SPACER BARS: With parts on racks, soak in diluted cleaning solution for 5 – 10 minutes, brush/wipe down any areas with significant resin build-up then rinse. Pressure washer OK. HELICAL BLADES: Place helical blades in blade racks. If resin build-up is minimal, simply wipe down with cleaning wipe or cloth. If resin build-up is more significant, spray blades with cleaner, avoiding the bearings on either end, and let sit for 5 minutes. Brush/wipe down any areas with significant resin build-up then rinse. Pressure washer OK on blades, but not on bearing blocks. To clean bearing blocks, place blades on support racks. Use a cleaning wipe to hand-clean bearing blocks, as necessary
SEPARATOR HOUSING FAN HOUSING (Stainless Steel Versions)	10 - 13	STEP 1 - CLEAN - Super Clean , - Tub O' Towels Heavy Duty Cleaning Wipes and/or - RESIN8 XTRA STEP 2 - RINSE with water STEP 3 - SANITIZE, IF NECESSARY - Shyield or Isopropyl	Spray with diluted cleaning solution, let sit for 5 – 10 minutes, brush/wipe down any areas with significant resin build-up then rinse. Pressure washer OK.

MOBIUS PART	RECOMMENDED PH RANGE OF CLEANER	RECOMMENDED CLEANER(S)	RECOMMENDED CLEANING PROCEDURE
SEPARATOR HOUSING FAN HOUSING (Anodized Aluminum Versions)	8.5 – 10	<p>STEP 1 - CLEAN - Tub O' Towels Heavy Duty Cleaning Wipes and/or - RESIN8 XTRA</p> <p>STEP 2 - RINSE with water</p> <p>STEP 3 - SANITIZE, IF NECESSARY - Shyield or Isopropyl</p>	Spray with diluted cleaning solution, let sit for 5 – 10 minutes, brush/wipe down any areas with significant resin build-up then rinse. Pressure washer OK.
LID SCREENS BLUE TUMBLER RETAINING RINGS	8.5 – 10	<p>STEP 1 - CLEAN - Tub O' Towels Heavy Duty Cleaning Wipes and/or - RESIN8 XTRA</p> <p>STEP 2 - RINSE with water</p> <p>STEP 3 - SANITIZE, IF NECESSARY - Shyield or Isopropyl</p>	Spray with diluted cleaning solution, let sit for 5 – 15 minutes, brush/wipe down areas with significant resin build-up then rinse. Pressure washer OK.
MOBIUS BODY & LID	8.5 – 10	<p>STEP 1 - CLEAN - Tub O' Towels Heavy Duty Cleaning Wipes and/or - RESIN8 XTRA</p> <p>STEP 2 - RINSE with water</p> <p>STEP 3 - SANITIZE, IF NECESSARY - Shyield or Isopropyl</p>	<p>Spray areas that require cleaning with diluted cleaning solution. Allow cleaner to sit for 5 – 10 minutes, then wipe down with a cleaning wipe or soft cloth. For areas with significant resin buildup, a plastic razor blade can be used to scrape off resin before wiping down.</p> <p>Note 1: Do not pressure wash Mobius body and avoid spraying control panel and other electrical components.</p> <p>Note 2: Use compressed air to blow down gears and belts on left side of machine.</p>

MOBIUS PART	RECOMMENDED PH RANGE OF CLEANER	RECOMMENDED CLEANER(S)	RECOMMENDED CLEANING PROCEDURE
TUMBLER BRUSH	10 – 13	<p>STEP 1 - CLEAN</p> <ul style="list-style-type: none"> - Super Clean, - Tub O' Towels Heavy Duty Cleaning Wipes and/or - RESIN8 XTRA <p>STEP 2 - RINSE with water</p> <p>STEP 3 - SANITIZE, IF NECESSARY</p> <ul style="list-style-type: none"> - Shyield or Isopropyl 	<p>AUTOMATIC TUMBLER AND BRUSH WASHER: Add 1 part cleaner to 4 parts hot water, turn on, allow tumbler and brush to rotate for 5-10mins. Rinse with water. Apply sanitizer.</p> <p>MANUAL CLEANING: Soak in diluted cleaning solution for 5 – 15 minutes, brush/wipe down any areas with significant resin build-up then rinse. Pressure washer OK.</p>
TRIM TOTE TRIM TOTE GASKET	10 – 13	<p>STEP 1 - CLEAN</p> <ul style="list-style-type: none"> - Super Clean, - Tub O' Towels Heavy Duty Cleaning Wipes and/or - RESIN8 XTRA <p>STEP 2 - RINSE with water</p> <p>STEP 3 - SANITIZE, IF NECESSARY</p> <ul style="list-style-type: none"> - Shyield or Isopropyl 	<p>Spray with or soak in diluted cleaning solution for 5 – 15 minutes, brush/wipe down any areas with significant resin build-up then rinse. Pressure washer OK.</p>
IMPELLER FAN	10 – 13	<p>STEP 1 - CLEAN</p> <ul style="list-style-type: none"> - Super Clean, - Tub O' Towels Heavy Duty Cleaning Wipes and/or - RESIN8 XTRA <p>STEP 2 - RINSE with water</p> <p>STEP 3 - SANITIZE, IF NECESSARY</p> <ul style="list-style-type: none"> - Shyield or Isopropyl 	<p>Wipe down impeller blades with a cleaning wipe or cloth, then rinse.</p>

MOBIUS PART	RECOMMENDED PH RANGE OF CLEANER	RECOMMENDED CLEANER(S)	RECOMMENDED CLEANING PROCEDURE
FAN HOUSING FILTER BAG (200 mesh)	10 – 13	STEP 1 - CLEAN - Super Clean , - Tub O' Towels Heavy Duty Cleaning Wipes and/or - RESIN8 XTRA STEP 2 - RINSE with water STEP 3 - SANITIZE, IF NECESSARY - Shyield or Isopropyl	Soak in diluted cleaning solution for 5 – 15 minutes, then rinse. Pressure washer OK.
FAN HOUSING FILTER BAG (MERV 8 Material)	N/A	Compressed Air	In a well-ventilated area, use compressed air to blow out the filter bag. Note, filter bag should be replaced on a regular basis.



Eteros Technologies West
202-17665 66A Ave.
Surrey, BC
V3S 2A7

Eteros Technologies East
502-130 Industrial Ave.
Carleton Place, ON
K7C 3T2

1-866-874-6244
INFO@MOBIUSTRIMMER.COM
MOBIUSTRIMMER.COM