

AC INFINITY

PROPAGATION SYSTEM

HUMIDITY CONTROLLED ENVIRONMENT

USER MANUAL

WELCOME

Thank you for choosing AC Infinity. We are committed to product quality and friendly customer service. If you have any questions or suggestions, please don't hesitate to [contact](#) us. Visit www.acinfinity.com and click contact for our contact information.

EMAIL

support@acinfinity.com

WEB

www.acinfinity.com

LOCATION

Los Angeles, CA

MANUAL CODE HD2202X1

PRODUCT

Humidity Dome
Heated Humidity Dome
Propagation Kit
Propagation System

MODEL

AC-HDA5
AC-HDM5
AC-HDL5
AC-HMX5

UPC-A

819137023208
819137023420
819137023215
819137023413

MANUAL INDEX

Manual Index	Page 5
Product Warning	Page 6
Key Features	Page 7
Product Contents	Page 8
Installation: Humidity Dome	Page 9
Installation: IONBEAM LED Light Bars	Page 11
Installation: SUNCORE Seedling Mat	Page 13
Controller Mounting	Page 14
Cleaning	Page 15
Programming	Page 17
Starter Guide	Page 19
Connecting to UIS™	Page 25
Other AC Infinity Products	Page 27
Warranty	Page 28

PRODUCT WARNING



TO REDUCE THE RISK OF FIRE, ELECTRIC SHOCK, OR INJURY TO PERSONS, OBSERVE THE FOLLOWING:

1. Ensure your power source conforms to the electrical requirements of this product.
2. Read all instructions before installing and using this product.
3. Be careful not to damage or cut the wire insulation (covering) during the installation. Do not permit wires to come in contact with any sharp edges.
4. If you are unfamiliar or have doubts about performing this product's installation, seek the services of a qualified, trained, and licensed professional. Inappropriate installation will void this product's warranty.
5. This product must not be used in potentially hazardous locations such as flammable, explosive, chemical-laden or wet atmospheres.
6. Do not cover power cords or seedling mat with rugs or other fabric materials.
7. Safety precautions should be exercised during the installation, operation, and maintenance of this product.
8. Do not block or tamper with this product in any manner while it is in operation as it may cause electric shock, fire, or damage to this product.
9. Do not depend on the on/off programming as the sole means of shutting power from this product. Unplug the power cord before installing, servicing, or moving this product.
10. Do not operate this product while its cord is damaged, or if it malfunctions, has been dropped, or is damaged in any manner.

KEY FEATURES

LOCKED-IN HUMIDITY

Two built-in rotating vents set on top of the humidity dome provide precision control to tightly keep moisture in or lower interior humidity levels.

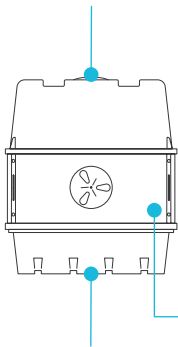

HEAVY-DUTY BUILD

Long-lasting, durable tray with a 5x8 cell grid design that supports up to 40 seedlings and drains excess water.

DOMED LED LIGHTING*

Duo LED light bars and lighting controller with four intensity settings for each stage in your plant's grow cycle and four timer settings that repeat daily.

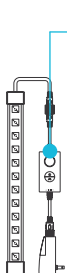

CLONE-FRIENDLY

Transparent dome extender with adjustable vents provides a higher ceiling to fit taller plants in clone propagation applications.

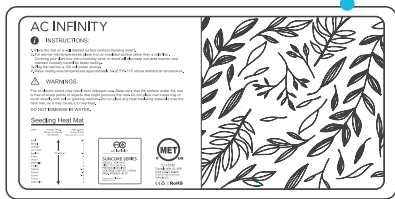

SEED STARTING BASE*

IP-67 rated heating pad improves germination and rooting, emitting a steady output of heat while insulating your seedling tray.

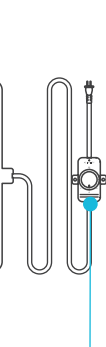

TEMPERATURE CONTROL

Built-in dial controller gradually adjusts the far infrared heating film to provide uniform heating output in custom low, medium, and high settings.

*Included only in select models

PRODUCT CONTENTS

HUMIDITY DOME



HUMIDITY
DOME
(x1)



VENTED
PANEL
(x2)

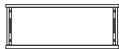

SIDE
PANEL
(x2)



BASE
TRAY
(x1)



VENT
DISKS
(x4)

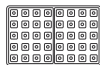

SEEDLING
TRAY
(x1)



BOLT AND
WING NUTS
(x8)

IONBEAM LED LIGHT BARS (AC-HDL5, AC-HMX5)



LIGHT BAR
(SINGLE-CORDED)
(x1)



LIGHT BAR
(DUAL-CORDED)
(x1)



LIGHT
CONTROLLER
(x1)

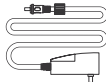

POWER
ADAPTER
(x1)

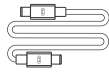

UIS EXTENSION
CORD (M-M)
(x1)



HOOK AND LOOP
CABLE TIES
(x4)



WIRE
MOUNT
(x1)



WOOD SCREWS
(WALL MOUNT)
(x1)



ADHESIVE
MAGNET
(x1)

SUNCORE SEEDLING MATS (AC-HDM5, AC-HMX5)



SEEDLING
MAT
(x1)



CONTROLLER
SCREW SET
(x2)

INSTALLATION

HUMIDITY DOME

STEP 1

Place the seedling tray into the base tray.

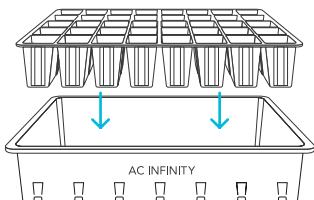

STEP 2

Assemble the dome extender, keeping the vented panels on opposite ends and applying the plastic screw and nuts to secure the corners.

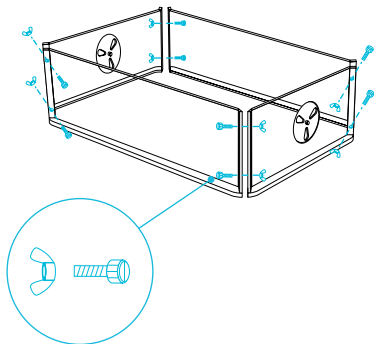

INSTALLATION

HUMIDITY DOME

STEP 3

Snap the vent disks into the openings.

Adjust the vents as needed.

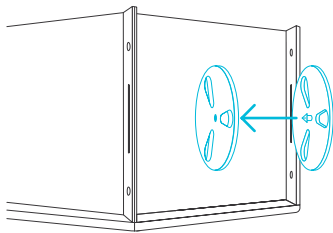

STEP 4

Place the dome over the tray.

You may also place the dome extender in between the tray and dome as an option.

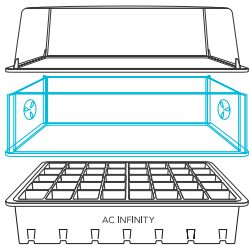

INSTALLATION

IONBEAM LED LIGHT BARS

STEP 1

Assemble the light bar chain.

- A. Connect the single-corded LED light bar's female port to the dual-corded LED light bar's male connector.
- B. Connect the light controller's male connector to the other end of the dual-corded LED light bar.
- C. Connect the power adapter to the light controller.

Secure all connections using the twist-on pieces.

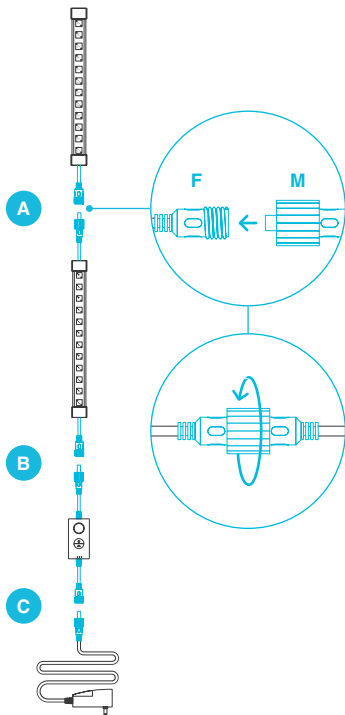

INSTALLATION

IONBEAM LED LIGHT BARS

STEP 2

Place the LED light bars on top of the dome. Its diodes should fit snugly into the divots of the dome.

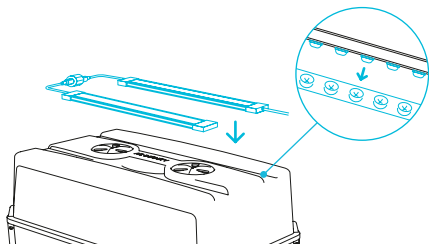

STEP 3

Plug the power adapter into a wall outlet to power the LED light bars.

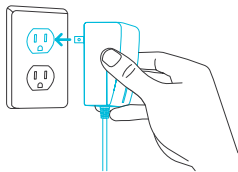

INSTALLATION

SUNCORE SEEDLING MAT

STEP 1

Unroll the seedling mat flat on to the ground.

Do not allow the mat to overlap onto itself.

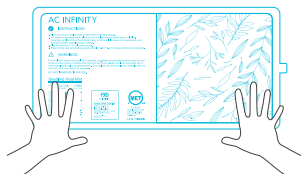

STEP 2

Connect the AC power plug to a power outlet to turn on the seedling mat.

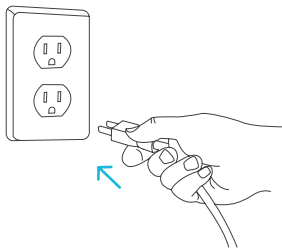

CONTROLLER MOUNTING

IONBEAM LED LIGHT BARS

MAGNET MOUNTING

You may magnetically mount the light controller by applying the included adhesive magnet onto your humidity dome.

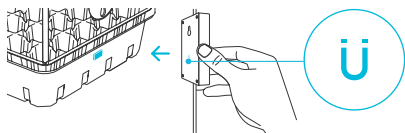

STEP 1 — WALL MOUNTING

Locate a spot free of obstruction and secure the anchor into your wall. Twist the wood screw into the anchors.

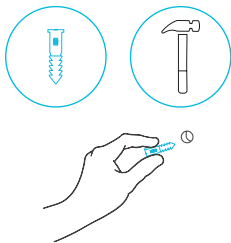

STEP 2 — WALL MOUNTING

Use the mounting hole located on the back of the controller for wall mount.

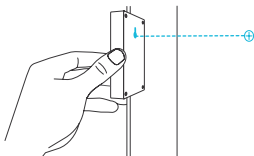

CLEANING

STEP 1

Dip or soak a cloth with your preferred solvent.

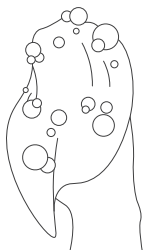

STEP 2

Separate each section and wipe each item to clear them of any debris.

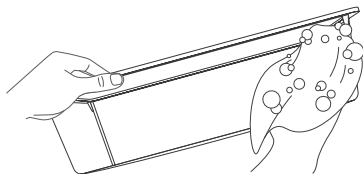

CLEANING

STEP 3

Using a dry cloth, pat or wipe each item and set them aside upside-down to dry.

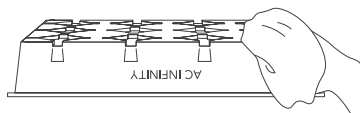

PROGRAMMING

LIGHT CONTROLLER

1. LIGHTING

Pressing the light button will increase the light intensity level in 10/30/60/100% increments, displayed with white LED indicators. Pressing this button at 100% intensity will cycle to 0%.

Holding the light button will shut off the lighting. Pressing it again will return the light intensity to its previous setting.

2. TIMER

Pressing the clock button will set the timer in 3/6/12/18-hour increments, displayed with orange LED indicators.

Within a 24-hour cycle, lighting will be active for the amount of time set here (ex. 3 hours for a 3HR timer). It will deactivate for the rest of the 24-hour cycle (ex. 21 hours).

Pressing the clock button at the 18HR setting will deactivate the timer, cycling from 3HR onwards when pressing this button again.

3. UIS CONNECTION

Refer to the programming section of your selected UIS controller for programming instructions.

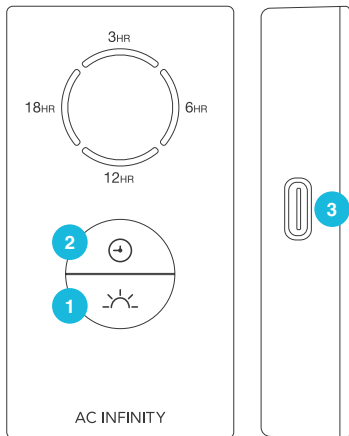

PROGRAMMING

HEATING CONTROLLER

LIGHT INDICATOR

When the controller is turned on and receiving power, the LED at the top of the controller will light up to show it is on.

ON

Turn the knob clockwise until you hear and feel a click to turn on the seedling mat.

OFF

Turn the knob counterclockwise from ON until you hear and feel a click to turn off the seedling mat.

SPEED CONTROL

Turning the knob will gradually adjust the heat between low, medium, and high.

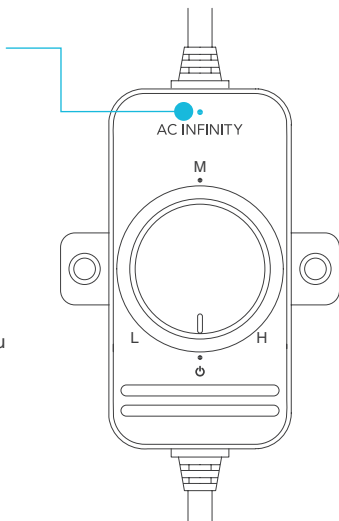

STARTER GUIDE

HUMIDITY DOME AND SEEDLING MAT

GROWING SEASONS

You may use a seedling mat to get a head start on the gardening season. Start the germination process during late winter or spring if you live in a colder region.

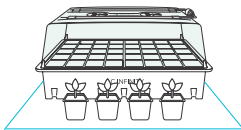

GERMINATION

Different seeds require different temperatures to germinate. Before you begin, refer to your seed package and the table on the seedling mat for recommended temperature settings.

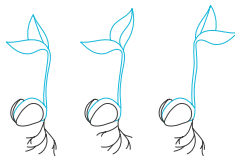

TEMPERATURE

If your seed packet does not specify a temperature, keep the temperature between 65°F and 75°F (18-24°C).

Make sure to also keep track of ambient room temperatures; along with your local weather, this can also affect your germination process.

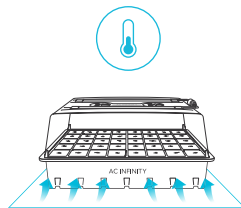

STARTER GUIDE

HUMIDITY DOME AND SEEDLING MAT

HUMIDITY

Closing the vents of the humidity dome will increase the humidity of the environment. To accelerate the environmental humidity build-up, pair the humidity dome with a seedling mat.

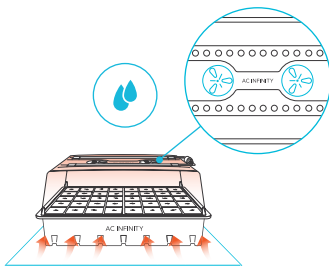

SOWING SEEDS

Sow 2-3 seeds per cell; not every seed will germinate. Cover the seeds completely with your grow media. Set the humidity dome over the tray. Place the seed tray on the seedling mat and turn it on to begin heating.

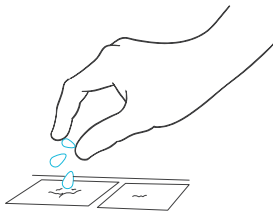

STARTER GUIDE

HUMIDITY DOME AND SEEDLING MAT

WATERING

Water your seed tray's starter mix or pellets, which will appear dark brown. Dry off any excess water.

Place the humidity dome on the seed tray and close all air vents. Lightly water your seeds whenever the mix/pellets appear light brown.

Once your seeds begin to germinate, open an air vent on the humidity dome. When about half of your tray yields seedlings, open two of the air vents on the humidity dome.

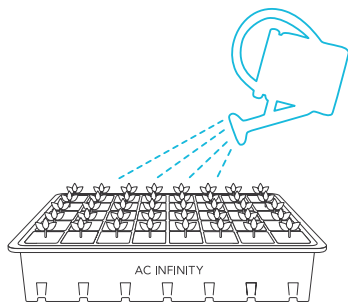

STARTER GUIDE

FULL SPECTRUM LIGHTING

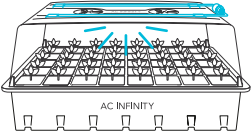
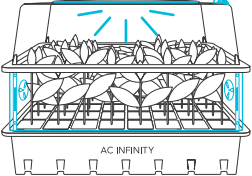

The charts below offer suggested mounting heights and light intensities for each stage in the growing process. These factors will vary based on the plant you are growing. Height refers to the minimum recommended distance from the canopy (tip of the plant) to the light.

GROW STAGE	Height	Intensity	Set-Up
Seedling Stage	1 IN.	10%*	
Vegetative Stage	2 IN.	30%*	

*Also recommended for plant propagation.

STARTER GUIDE

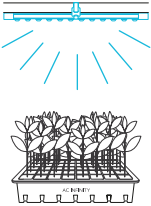
FULL SPECTRUM LIGHTING

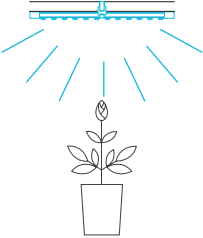
GROW STAGE	Height	Intensity	Set Up
Vegetative Stage	6 IN.		
Flowering Stage	6 IN.		

STARTER GUIDE

FULL SPECTRUM LIGHTING

SETTING ACTIVE LIGHTING TIMERS

The included controller can set timers in 3/6/12/18-hour increments.

Use either the 3HR or the 6HR timer to extend your plant's daily exposure to light, in conjunction with natural sunlight, or when growing plants that don't require extended exposure to lighting.

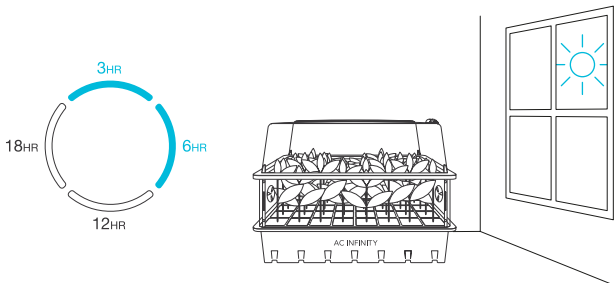

Use either the 12HR or the 18HR timer to complement common light cycles used to grow high yield plants indoors. This will also allow for your lighting to sync with your grow set-up's existing lighting, so that they may activate at the same time.

CONNECTING TO UIS™

AN INTERCONNECTED GROW SETUP

The Universal Infinity System (UIS) is a series of controllers and devices that come together to create a fully automated system. UIS enables our controllers to simultaneously connect with various grow equipment such as inline fans, clip-on fans, and grow lights. Advance UIS controllers can provide each connected UIS device with their own automated programming like temperature, humidity, cycles, schedules, and dynamic levels, while also pairing with the AC Infinity app.

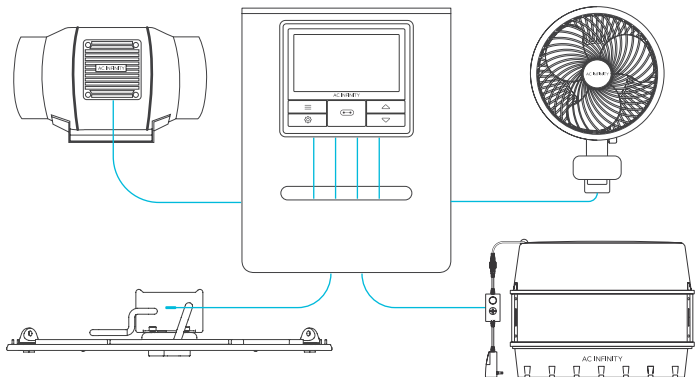

CONNECTING TO UIS™

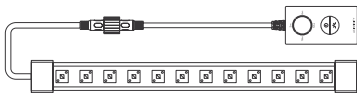

IONBEAM LED grow lights can connect with select smart controllers as part of an integrated system using the included UIS extension cord.

CONNECTING TO UIS CONTROLLERS

Use the included UIS M-M extension cord to connect the LED light bar(s) to your selected UIS controller via the light controller's side port.

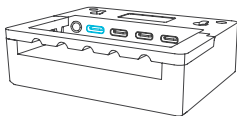
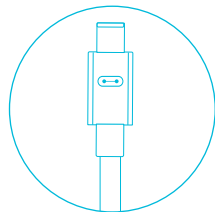

Your selected UIS controller will override all of the light controller's onboard settings when connected in this manner.

AC INFINITY PRODUCTS

Advance Grow Tents

The CLOUDLAB series is a line of grow tents designed to create ideal growing conditions and facilitate indoor plant cultivation year-round. Features 2000D thick oxford canvas lined with inner diamond patterned mylar that maximizes grow light luminosity, and a reinforced frame with 150 lb. weight capacity. Includes a mounting plate to install your AC Infinity controller onto.

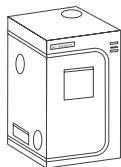

Fabric Pots

A set of gardening grow bags designed to create wider root networks and improve plant growth by air pruning roots while draining excess water. Features industry leading 500G thick nonwoven fabric sewn with metal rings to enable air-suspended hanging or twist tie pass-through for low stress plant training.

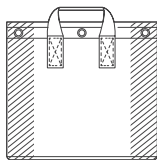

Inline Duct Fans

The CLOUDLINE series is a line of duct fans designed to quietly ventilate AV rooms and closets, as well as various DIY air circulation and exhaust projects. Features a thermal controller with intelligent programming that will automatically adjust duct fan speeds in response to changing temperatures.

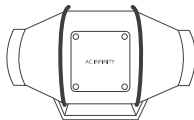

Discover the latest innovations in cooling and ventilation at acinfinity.com

WARRANTY

This warranty program is our commitment to you, the product sold by AC Infinity will be free from defects in manufacturing for a period of two years from the date of purchase. If a product is found to have a defect in material or workmanship, we will take the appropriate actions defined in this warranty to resolve any issues.

The warranty program applies to any order, purchase, receipt, or use of any products sold by AC Infinity or our authorized dealerships. The program covers products that have become defective, malfunctioned, or expressively if the product becomes unusable. The warranty program goes into effect on the date of purchase. The program will expire two years from the date of purchase. If your product becomes defective during that period, AC Infinity will replace your product with a new one or issue you a full refund.

The warranty program does not cover abuse or misuse. This includes physical damage, submersion of the product in water, incorrect installation such as wrong voltage input, and misuse for any reason other than its intended purpose. AC Infinity is not responsible for consequential loss or incidental damages of any nature caused by the product. We will not warrant damage from normal wear such as scratches and dings.

For more information about our dealers and distributors, please contact our customer service at support@acinfinity.com or (626) 838-4656 Monday to Friday (9:00 am to 5:00 pm PST).



If you have any issues with this product, contact us and we'll happily resolve your problem or issue a full refund!

COPYRIGHT © 2022 AC INFINITY INC. ALL RIGHTS RESERVED

No part of the materials including graphics or logos available in this booklet may be copied, photocopied, reproduced, translated or reduced to any electronic medium or machine readable form, in whole or in part, without specific permission from AC Infinity Inc.

www.acinfinity.com