

Electrically held lighting contactor, (convertible to mech. held), Amp rating 30A (tungsten 20A), 1 N.C. / 7 N.O. poles, 575-600V 60Hz/550V 50Hz coil, Non-combination type, Enclosure NEMA type 1, Indoor general purpose use



Figure similar

| | |
|--|---|
| Product brand name | Class LC |
| Design of the product | Electrically held lighting contactor (convertible to mechanically held) |
| Special product feature | Electrically held convertible to mechanically held; Power poles convertible between NO and NC |
| General technical data | |
| Weight [lb] | 11 lb |
| Height x Width x Depth [in] | 14 × 8 × 7 in |
| Protection against electrical shock | NA for enclosed products |
| Installation altitude [ft] at height above sea level maximum | 6560 ft |
| Ambient temperature [°F] | |
| • during storage | -22 ... +149 °F |
| • during operation | -13 ... +104 °F |
| Ambient temperature | |
| • during storage | -30 ... +65 °C |
| • during operation | -25 ... +40 °C |
| Country of origin | USA |

| Contactor | |
|--|--|
| Size of contactor | 30 Amp |
| Number of NO contacts for main contacts | 7 |
| Number of NC contacts for main contacts | 1 |
| Operating voltage for main current circuit at AC at 60 Hz maximum | 600 V |
| Mechanical service life (switching cycles) of the main contacts typical | 100000 |
| Contact rating of the main contacts of lighting contactor | |
| <ul style="list-style-type: none"> • at tungsten (1 pole per 1 phase) rated value • at tungsten (2 poles per 1 phase) rated value • at tungsten (3 poles per 3 phases) rated value • at ballast (1 pole per 1 phase) rated value • at ballast (2 poles per 1 phase) rated value • at ballast (3 poles per 3 phases) rated value • at resistive load (1 pole per 1 phase) rated value • at resistive load (2 poles per 1 phase) rated value • at resistive load (3 poles per 3 phases) rated value | 20A @277V 1p 1ph 20A @480V 2p 1ph 20A @480V 3p 3ph 30A @347V 1p 1ph 30A @600V 2p 1ph 30A @600V 3p 3ph 30A @600V 1p 1ph 30A @600V 2p 1ph 30A @600V 3p 3ph |
| Auxiliary contact | |
| Number of NC contacts for auxiliary contacts | 0 |
| Number of NO contacts for auxiliary contacts | 0 |
| Number of total auxiliary contacts maximum | 4 |
| Contact rating of auxiliary contacts of contactor according to UL | NA |
| Coil | |
| Type of voltage of the control supply voltage | AC |
| Control supply voltage | |
| <ul style="list-style-type: none"> • at AC at 50 Hz rated value • at AC at 60 Hz rated value | 550 V 575 ... 600 V |
| Apparent pick-up power of magnet coil at AC | 248 V·A |
| Apparent holding power of magnet coil at AC | 28 V·A |
| Operating range factor control supply voltage rated value of magnet coil | 0.85 ... 1.1 |
| Enclosure | |
| Degree of protection NEMA rating of the enclosure | NEMA Type 1 |
| Design of the housing | Indoor general purpose use |
| Mounting/wiring | |
| Mounting position | Vertical |

| | |
|---|-----------------------------------|
| Mounting type | Surface mounting and installation |
| Type of electrical connection for supply voltage line-side | Screw-type terminals |
| Tightening torque [lbf-in] for supply | 35 ... 35 lbf-in |
| Type of connectable conductor cross-sections at line-side at AWG conductors single or multi-stranded | 2x (14 ... 8 AWG) |
| Temperature of the conductor for supply maximum permissible | 75 °C |
| Material of the conductor for supply | CU |
| Type of electrical connection for load-side outgoing feeder | Screw-type terminals |
| Tightening torque [lbf-in] for load-side outgoing feeder | 35 ... 35 lbf-in |
| Type of connectable conductor cross-sections at AWG conductors for load-side outgoing feeder single or multi-stranded | 2x (14 ... 8 AWG) |
| Temperature of the conductor for load-side outgoing feeder maximum permissible | 75 °C |
| Material of the conductor for load-side outgoing feeder | CU |
| Type of electrical connection of magnet coil | Screw-type terminals |
| Tightening torque [lbf-in] at magnet coil | 15 ... 15 lbf-in |
| Type of connectable conductor cross-sections of magnet coil at AWG conductors single or multi-stranded | 2x (18 ... 14 AWG) |
| Temperature of the conductor at magnet coil maximum permissible | 75 °C |
| Material of the conductor at magnet coil | CU |

Short-circuit current rating

| | |
|--|-----------------------------------|
| Design of the fuse link for short-circuit protection of the main circuit required | 100kA@600V (Class R or J 40A max) |
| Design of the short-circuit trip | Thermal magnetic circuit breaker |
| Maximum short-circuit current breaking capacity (Icu) <ul style="list-style-type: none"> • at 240 V • at 480 V • at 600 V | 24 kA 65 kA 25 kA |
| Certificate of suitability | NEMA ICS 2; UL 508 |

Further information

Industrial Controls - Product Overview (Catalogs, Brochures,...)

www.usa.siemens.com/iccatalog

Industry Mall (Online ordering system)

<https://mall.industry.siemens.com/mall/en/us/Catalog/product?mlfb=US2:LCE01C107600A>

Service&Support (Manuals, Certificates, Characteristics, FAQs,...)

<https://support.industry.siemens.com/cs/US/en/ps/US2:LCE01C107600A>

Image database (product images, 2D dimension drawings, 3D models, device circuit diagrams, EPLAN macros, ...)

http://www.automation.siemens.com/bilddb/cax_de.aspx?mlfb=US2:LCE01C107600A&lang=en

Certificates/approvals

<https://support.industry.siemens.com/cs/US/en/ps/US2:LCE01C107600A/certificate>



| LETTER | KNOCKOUT & CONDUIT SIZE |
|--------|---|
| A | %%C22.2 X %%C28.6 FOR 12.7 & 19 CONDUIT |
| B | %%C28.6 X %%C34.9 FOR 19 & 25.4 CONDUIT |
| C | %%C34.9 X %%C43.6 FOR 25.4 & 31.8 CONDUIT |



OPTIONAL
AUXILIARY
CONTACTS

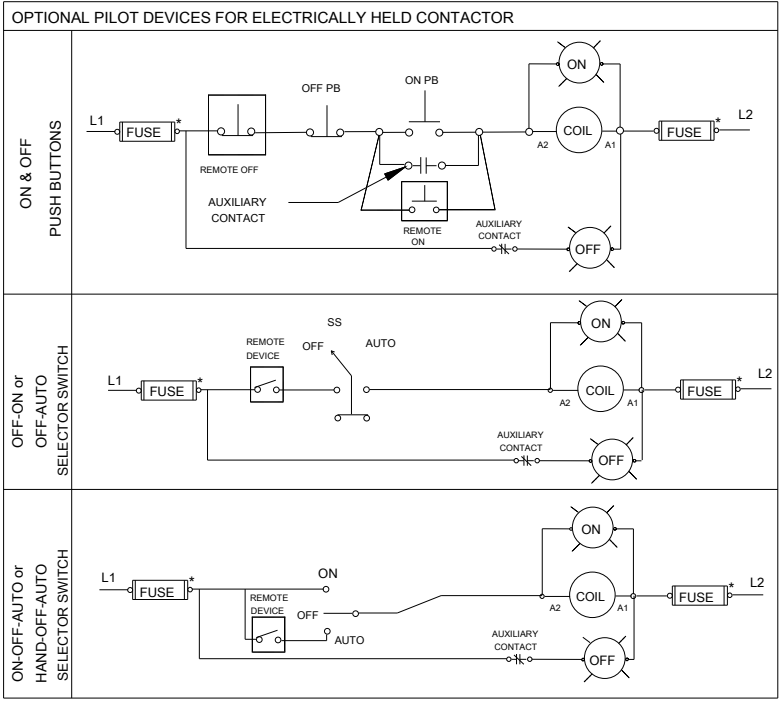

* -- IF USED

D38297001

last modified:

04/10/2020