



Model Number

NMB2-12GM40-Z3-C-FE-300MM-V1

Features

- Stainless steel sensing face
- Sensing range 2 mm
- 2-wire DC
- Weld field immune
- Weld slag resistant coating
- Ferrous targets

Connection

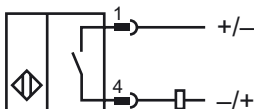

Pinout

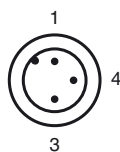

Wire colors in accordance with EN 60947-5-2

1	BN	(brown)
3	BU	(blue)
4	BK	(black)

Accessories

V1-G-OR2M-POC
Female cordset, M12, 4-pin, TPE cable, welding-bead resistant

AB-12
Mounting aid

Dimensions

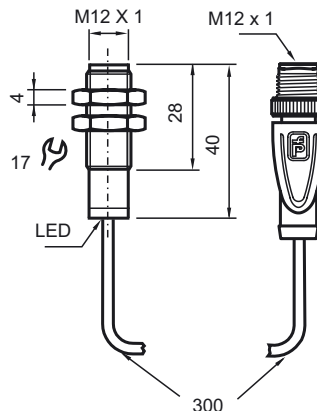

Technical Data

General specifications

Switching element function	DC	NO
Rated operating distance	s_n	2 mm
Installation	flush	
Output polarity	DC	
Assured operating distance	s_a	0 ... 1.62 mm
Actuating element	Ferrous targets	
Reduction factor r_{Al}	0	
Reduction factor r_{Cu}	0	
Reduction factor r_{304}	0.6 - 0.8	
Reduction factor r_{S137}	1	
Reduction factor r_{Brass}	0	

Nominal ratings

Operating voltage	U_B	6 ... 30 V DC
Switching frequency	f	0 ... 5 Hz
Hysteresis	H	3 ... 15 typ. 5 %
Reverse polarity protection	reverse polarity protected	
Short-circuit protection	no	
Voltage drop	U_d	≤ 5.5 V DC
Operating current	I_L	2 ... 100 mA
Off-state current	I_r	≤ 800 μA
Switching state indication	LED, red	
Mag. Field strength, AC fields	250 mT	
Mag. Field strength, DC fields	250 mT	

Ambient conditions

Ambient temperature	-25 ... 70 °C (-13 ... 158 °F)
---------------------	--------------------------------

Mechanical specifications

Connection type	300 mm POC cable with 3-pin , M12 x 1 connector
Core cross-section	0.34 mm ²
Housing material	Xylan coated - Stainless steel 1.4305 / AISI 303
Sensing face	Xylan coated - Stainless steel 1.4305 / AISI 303
Protection degree	IP67 / IP68 / IP69K - cordset dependent according to cable specification

Compliance with standards and directives

Standard conformity	
Standards	EN 60947-5-2:2007 IEC 60947-5-2:2007

Approvals and certificates

UL approval	cULus Listed, General Purpose
CSA approval	cCSAus Listed, General Purpose
CCC approval	Products with a maximum operating voltage of ≤36 V do not bear a CCC marking because they do not require approval.

Release date: 2013-01-21 12:13 Date of issue: 2013-01-21 905037_eng.xml