

Protective collar for EMERGENCY STOP mushroom pushbutton, 60 mm, 22 mm design, for 3 padlocks, yellow, plastic



Product brand name	SIRIUS ACT
Product designation	Protective collar
Design of the product	for EMERGENCY STOP mushroom pushbuttons 60 mm, for 3 padlocks
Product type designation	3SU1
General technical data	
Protection class IP	IP66, IP67, IP69(IP69K)
Degree of protection NEMA rating	1, 2, 3, 3R, 4, 4X, 12
Installation/ mounting/ dimensions	
Height	58.9 mm
Width	74.8 mm
Depth	47.5 mm
Accessories	
Material of accessory	Plastic
Color of accessory	yellow
Certificates/ approvals	

General Product Approval	Declaration of Conformity	Test Certificates
--------------------------	---------------------------	-------------------



[Miscellaneous](#)

[Type Test Certificates/Test Report](#)

Marine / Shipping



other

[Confirmation](#)

Further information

Information- and Downloadcenter (Catalogs, Brochures,...)
<https://www.siemens.com/ic10>

Industry Mall (Online ordering system)
<https://mall.industry.siemens.com/mall/en/en/Catalog/product?mlfb=3SU1900-0EX30-0AA0>

Cax online generator
<http://support.automation.siemens.com/WW/CAXorder/default.aspx?lang=en&mlfb=3SU1900-0EX30-0AA0>

Service&Support (Manuals, Certificates, Characteristics, FAQs,...)
<https://support.industry.siemens.com/cs/ww/en/ps/3SU1900-0EX30-0AA0>

Image database (product images, 2D dimension drawings, 3D models, device circuit diagrams, EPLAN macros, ...)
http://www.automation.siemens.com/bilddb/cax_de.aspx?mlfb=3SU1900-0EX30-0AA0&lang=en

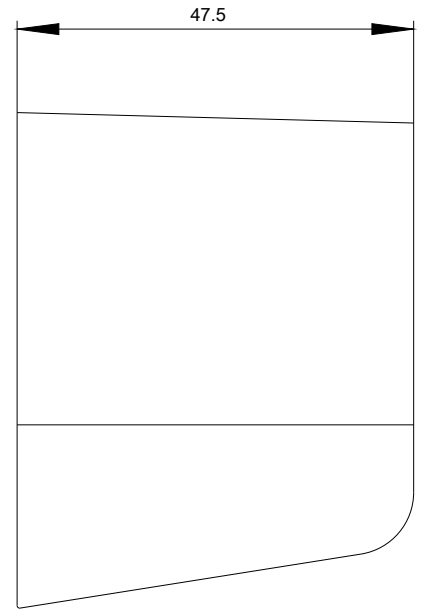
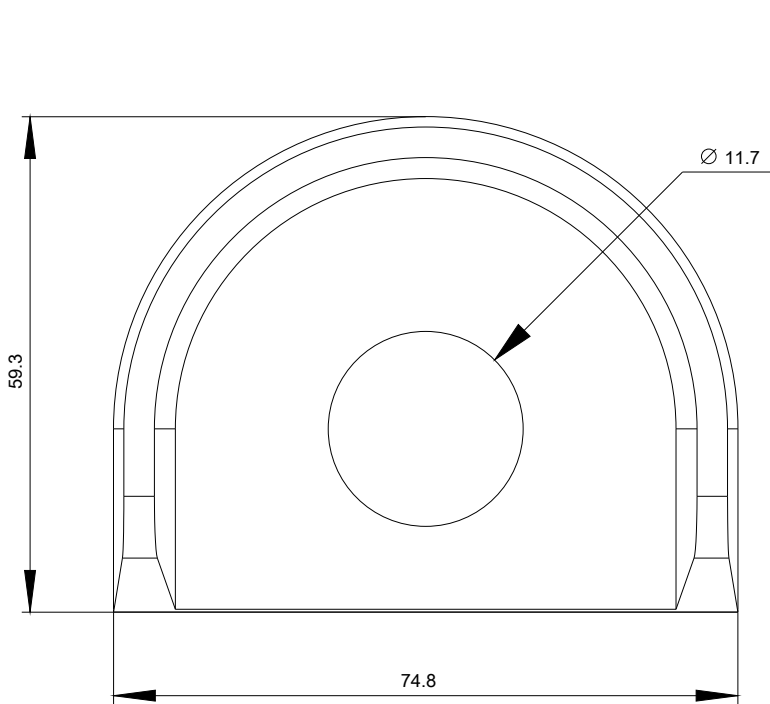

last modified:

03/06/2020