

Enclosure for 4 position knob, coordinate, ID key-operated switches and sensor switches, 22 mm, round, Enclosure material metal, enclosure top part gray, 1 control point metal, without equipment, only for front plate mounting



Product brand name	SIRIUS ACT
Product designation	Enclosures
Product type designation	3SU1

Enclosure	
Design of the housing	Command point in center
Shape of the enclosure front	Square
Material of the enclosure	metal
Number of command points	1
Product component	
• protective collar	No
Color	
• of top part of the enclosure	grey
Mounting type of the enclosure	Vertical / horizontal

General technical data	
Protection class IP	IP66, IP67, IP69(IP69K)
Degree of protection NEMA rating	1, 2, 3, 3R, 4, 4X, 12, 13
Shock resistance	
• for railway applications acc. to DIN EN 61373	Category 1, Class B
Vibration resistance	

• for railway applications acc. to DIN EN 61373	Category 1, Class B
Cable entry type	Without

Connections/ Terminals

Type of electrical connection on enclosure	Cable routing above and below, both 1 x M20
Tightening torque of mounting screws in the enclosure cover	1.5 ... 1.7 N·m







Ambient conditions



Ambient temperature	
• during operation	-25 ... +70 °C
• during storage	-40 ... +80 °C



Installation/ mounting/ dimensions

Mounting type	
• of modules and accessories	Front plate mounting
Height	89.4 mm
Width	85 mm
Depth	68 mm
Mounting diameter	22.3 mm
Positive tolerance of installation diameter	0.4 mm

Certificates/ approvals

General Product Approval	Declaration of Conformity
 CCC  CSA  UL  VDE  EAC  EG-Konf.	

Declaration of Conformity	Test Certificates	Marine / Shipping
Miscellaneous	Type Test Certificates/Test Report	Special Test Certificate
		 ABS  LRS  PRS

Marine / Shipping	other
 RINA  RMRS  DNV-GL <small>DNVGL.COM/AF</small>	Confirmation

Further information

Information- and Downloadcenter (Catalogs, Brochures,...)

<https://www.siemens.com/ic10>

Industry Mall (Online ordering system)

<https://mall.industry.siemens.com/mall/en/en/Catalog/product?mfb=3SU1851-1AA00-1AA1>

Cax online generator

<http://support.automation.siemens.com/WW/CAXorder/default.aspx?lang=en&mfb=3SU1851-1AA00-1AA1>

Service&Support (Manuals, Certificates, Characteristics, FAQs,...)

<https://support.industry.siemens.com/cs/ww/en/ps/3SU1851-1AA00-1AA1>

Image database (product images, 2D dimension drawings, 3D models, device circuit diagrams, EPLAN macros, ...)

http://www.automation.siemens.com/bilddb/cax_de.aspx?mfb=3SU1851-1AA00-1AA1&lang=en

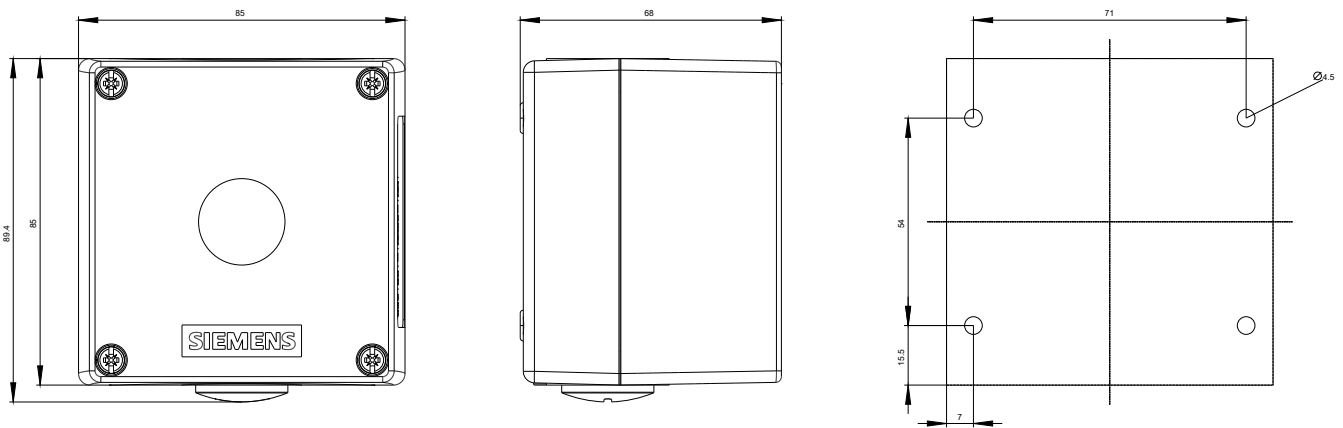

last modified:

03/06/2020