

Holder for 4 modules, metal, for selector switch with 4 switch positions and for coordinate switch

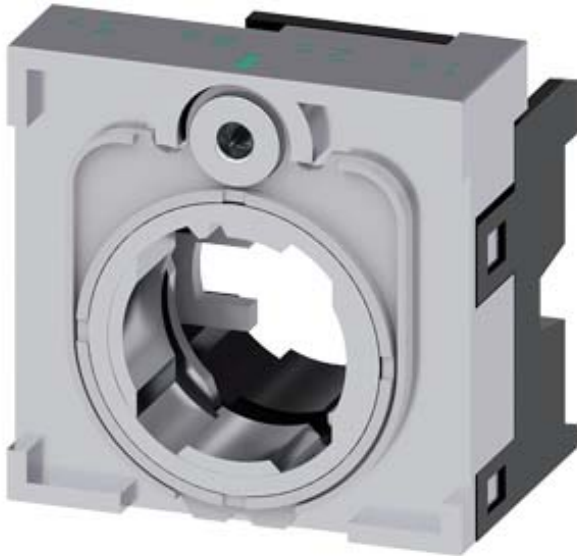

<b>Product brand name</b>	SIRIUS ACT
<b>Product designation</b>	Holders
<b>Product type designation</b>	3SU1
<b>Manufacturer's article number</b>	
<ul style="list-style-type: none"> <li>of the supplied holder</li> </ul>	<a href="#">3SU1550-0AA10-0AA0</a>
<b>Actuator</b>	
<b>Design of the operating mechanism</b>	4-way without module
<b>Number of contact modules</b>	0
<b>Holder</b>	
<b>Material of the holder</b>	Metal
<b>Display</b>	
<b>Number of LED modules</b>	0
<b>General technical data</b>	
<b>Product function</b>	
<ul style="list-style-type: none"> <li>positive opening</li> </ul>	No
<b>Product component</b>	
<ul style="list-style-type: none"> <li>diode</li> <li>lamp transformer</li> </ul>	No

<ul style="list-style-type: none"> <li>• Light source</li> </ul>	No
<ul style="list-style-type: none"> <li>• series resistor</li> </ul>	No
<b>Insulation voltage</b>	
<ul style="list-style-type: none"> <li>• rated value</li> </ul>	500 V
<b>Degree of pollution</b>	3
<b>Surge voltage resistance rated value</b>	6 kV
<b>Shock resistance</b>	
<ul style="list-style-type: none"> <li>• acc. to IEC 60068-2-27</li> <li>• for railway applications acc. to DIN EN 61373</li> </ul>	Sinusoidal half-wave 50 g / 11 ms Category 1, Class B
<b>Vibration resistance</b>	
<ul style="list-style-type: none"> <li>• acc. to IEC 60068-2-6</li> <li>• for railway applications acc. to DIN EN 61373</li> </ul>	10 ... 500 Hz: 5g Category 1, Class B
<b>Mechanical service life (switching cycles)</b>	
<ul style="list-style-type: none"> <li>• typical</li> </ul>	10
<b>Reference code acc. to DIN EN 81346-2</b>	U
<b>Reference code acc. to DIN EN 61346-2</b>	U





<b>Auxiliary circuit</b>	
<b>Number of NC contacts for auxiliary contacts</b>	0
<b>Number of NO contacts for auxiliary contacts</b>	0





<b>Connections/ Terminals</b>	
<b>Tightening torque of the screws in the bracket</b>	1 ... 1.2 N·m
<b>Tightening torque</b>	
<ul style="list-style-type: none"> <li>• for grounding</li> </ul>	0.8 ... 1 N·m

<b>Ambient conditions</b>	
<b>Ambient temperature</b>	
<ul style="list-style-type: none"> <li>• during operation</li> <li>• during storage</li> </ul>	-25 ... +70 °C -40 ... +80 °C
Environmental category during operation acc. to IEC 60721	3M6, 3S2, 3B2, 3C3, 3K6 (with relative air humidity of 10 ... 95 %, no condensation in operation permitted)

<b>Installation/ mounting/ dimensions</b>	
<b>Mounting type</b>	without
<ul style="list-style-type: none"> <li>• of modules and accessories</li> </ul>	Front plate mounting
<b>Height</b>	40 mm
<b>Width</b>	40 mm
<b>Shape of the installation opening</b>	round
<b>Installation width</b>	40 mm
<b>Installation depth</b>	32.1 mm

<b>Certificates/ approvals</b>	
--------------------------------	--

General Product Approval	Declaration of Conformity	Test Certificates	Marine / Shipping
 CSA	 EAC	 EG-Konf.	<a href="#">Miscellaneous</a> <a href="#">Type Test Certificates/Test Report</a>  ABS

Marine / Shipping	other
 LRS  PRS  RINA  RMRS  DNV-GL DNVGL.COM/AF	<a href="#">Confirmation</a>

### Further information

**Information- and Downloadcenter (Catalogs, Brochures,...)**

<https://www.siemens.com/ic10>

**Industry Mall (Online ordering system)**

<https://mall.industry.siemens.com/mall/en/en/Catalog/product?mlfb=3SU1550-0BA10-0AA0>

**Cax online generator**

<http://support.automation.siemens.com/WW/CAXorder/default.aspx?lang=en&mlfb=3SU1550-0BA10-0AA0>

**Service&Support (Manuals, Certificates, Characteristics, FAQs,...)**

<https://support.industry.siemens.com/cs/ww/en/ps/3SU1550-0BA10-0AA0>

**Image database (product images, 2D dimension drawings, 3D models, device circuit diagrams, EPLAN macros, ...)**

[http://www.automation.siemens.com/bilddb/cax\\_de.aspx?mlfb=3SU1550-0BA10-0AA0&lang=en](http://www.automation.siemens.com/bilddb/cax_de.aspx?mlfb=3SU1550-0BA10-0AA0&lang=en)

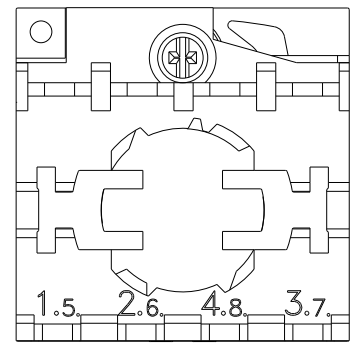
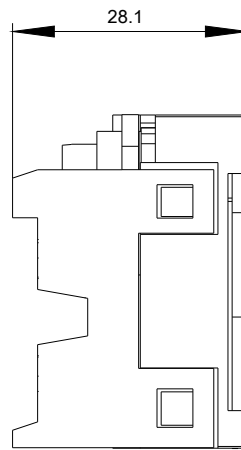
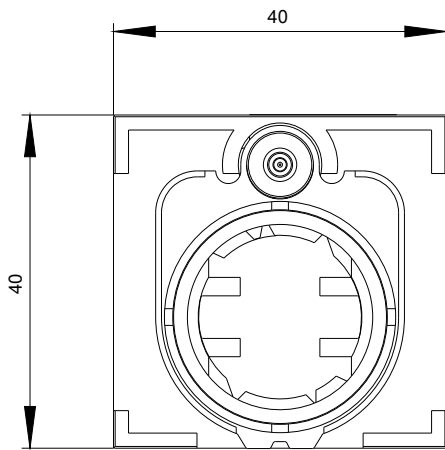

last modified:

02/18/2020