

Holder for 3 modules, plastic, 1 NO+1 NC, 1 NO+1 NC, LED module, blue, 6-24 V AC/DC, screw terminal

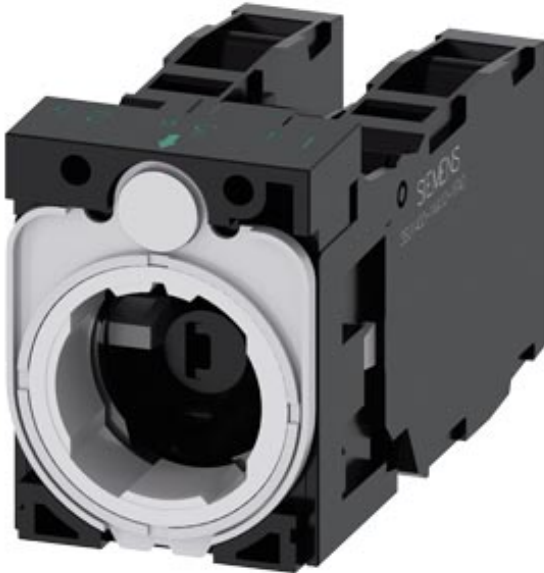

Product brand name	SIRIUS ACT
Product designation	Holders
Product type designation	3SU1
Manufacturer's article number	<ul style="list-style-type: none"> • of supplied contact module 3SU1400-1AA10-1FA0, 3SU1400-1AA10-1FA0 • 1 of supplied contact module 3SU1400-1AA10-1FA0 • 2 of supplied contact module 3SU1400-1AA10-1FA0 • of supplied LED module 3SU1401-1BG50-1AA0 • of the supplied holder 3SU1500-0AA10-0AA0
Actuator	
Design of the operating mechanism	3-way with module
Number of contact modules	2
Holder	
Material of the holder	Plastic
Display	
Number of LED modules	1
General technical data	

Product function	
• positive opening	Yes
Product component	
• diode	Yes
• lamp transformer	No
• Light source	Yes
• series resistor	No
Insulation voltage	
• rated value	320 V
Degree of pollution	3
Surge voltage resistance rated value	4 kV
Protection class IP	
• of the terminal	IP20
Shock resistance	
• acc. to IEC 60068-2-27	Sinusoidal half-wave 50 g / 11 ms
• for railway applications acc. to DIN EN 61373	Category 1, Class B
Vibration resistance	
• acc. to IEC 60068-2-6	10 ... 500 Hz: 5g
• for railway applications acc. to DIN EN 61373	Category 1, Class B
Operating frequency maximum	3 600 1/h
Mechanical service life (switching cycles)	
• typical	10
Thermal current	10 A
Reference code acc. to DIN EN 81346-2	U
Reference code acc. to DIN EN 61346-2	U
Continuous current of the C characteristic MCB	10 A; for a short-circuit current smaller than 400 A
Continuous current of the quick DIAZED fuse link	10 A
Continuous current of the DIAZED fuse link gG	10 A
Operating voltage	
• at AC	
— at 50 Hz rated value	6 ... 24 V
— at 60 Hz rated value	6 ... 24 V
• at DC	
— rated value	6 ... 24 V

Power Electronics

Contact reliability	One maloperation per 100 million (17 V, 5 mA), one maloperation per 10 million (5 V, 1 mA)
----------------------------	--

Control circuit/ Control

Inrush current of LED module maximum	2 A
---	-----

Auxiliary circuit

Design of the contact of auxiliary contacts	Silver alloy
--	--------------

Number of NC contacts for auxiliary contacts	2
Number of NO contacts for auxiliary contacts	2
Operating current at AC-15	6 A
• at 230 V rated value	

Connections/ Terminals

Type of electrical connection	Screw-type terminal
• of modules and accessories	
Type of connectable conductor cross-sections	2x (0.5 ... 0.75 mm ²) 2x (1.0 ... 1.5 mm ²) 2x (0.5 ... 1.5 mm ²) 2x (1,0 ... 1,5 mm ²) 2x (18 ... 14)
• solid with core end processing	
• solid without core end processing	
• finely stranded with core end processing	
• finely stranded without core end processing	
• at AWG conductors	
Tightening torque of the screws in the bracket	1 ... 1.2 N·m
Tightening torque	0.8 ... 0.9 N·m
• with screw-type terminals	

Lamp

Type of light source	LED
Color of the light source	blue
Light intensity	280 ... 710 mcd





Ambient conditions

Ambient temperature	-25 ... +70 °C -40 ... +80 °C
• during operation	
• during storage	
Environmental category during operation acc. to IEC 60721	3M6, 3S2, 3B2, 3K6 (with relative air humidity of 10 ... 95 %, no condensation in operation permitted)

Installation/ mounting/ dimensions

Mounting type	front panel mounting
• of modules and accessories	Front plate mounting
Height	40 mm
Width	30 mm
Shape of the installation opening	round
Installation width	30 mm
Installation depth	71.8 mm

Certificates/ approvals

General Product Approval		Declaration of Conformity		Test Certificates
 CCC	 CSA		 EG-Konf.	Miscellaneous Type Test Certificates/Test Report

Test Certificates	other
Special Test Certificate	Confirmation

Further information

Information- and Downloadcenter (Catalogs, Brochures,...)

<https://www.siemens.com/ic10>

Industry Mall (Online ordering system)

<https://mall.industry.siemens.com/mall/en/en/Catalog/product?mlfb=3SU1501-1AG50-1LA0>

Cax online generator

<http://support.automation.siemens.com/WW/CAXorder/default.aspx?lang=en&mlfb=3SU1501-1AG50-1LA0>

Service&Support (Manuals, Certificates, Characteristics, FAQs,...)

<https://support.industry.siemens.com/cs/ww/en/ps/3SU1501-1AG50-1LA0>

Image database (product images, 2D dimension drawings, 3D models, device circuit diagrams, EPLAN macros, ...)

http://www.automation.siemens.com/bilddb/cax_de.aspx?mlfb=3SU1501-1AG50-1LA0&lang=en

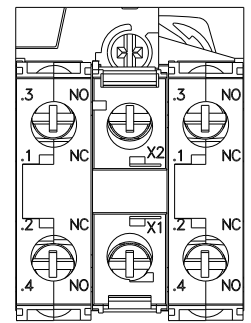
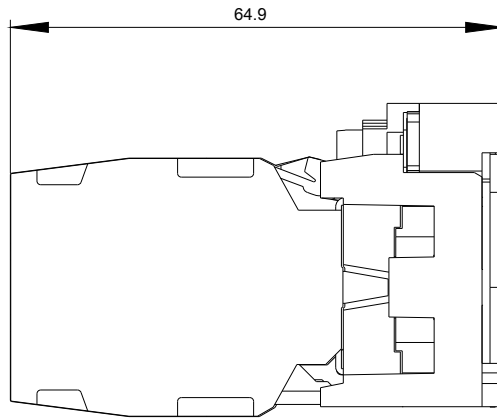
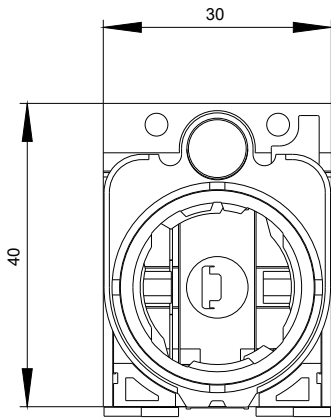

6-24 V AC/DC \bar{P}

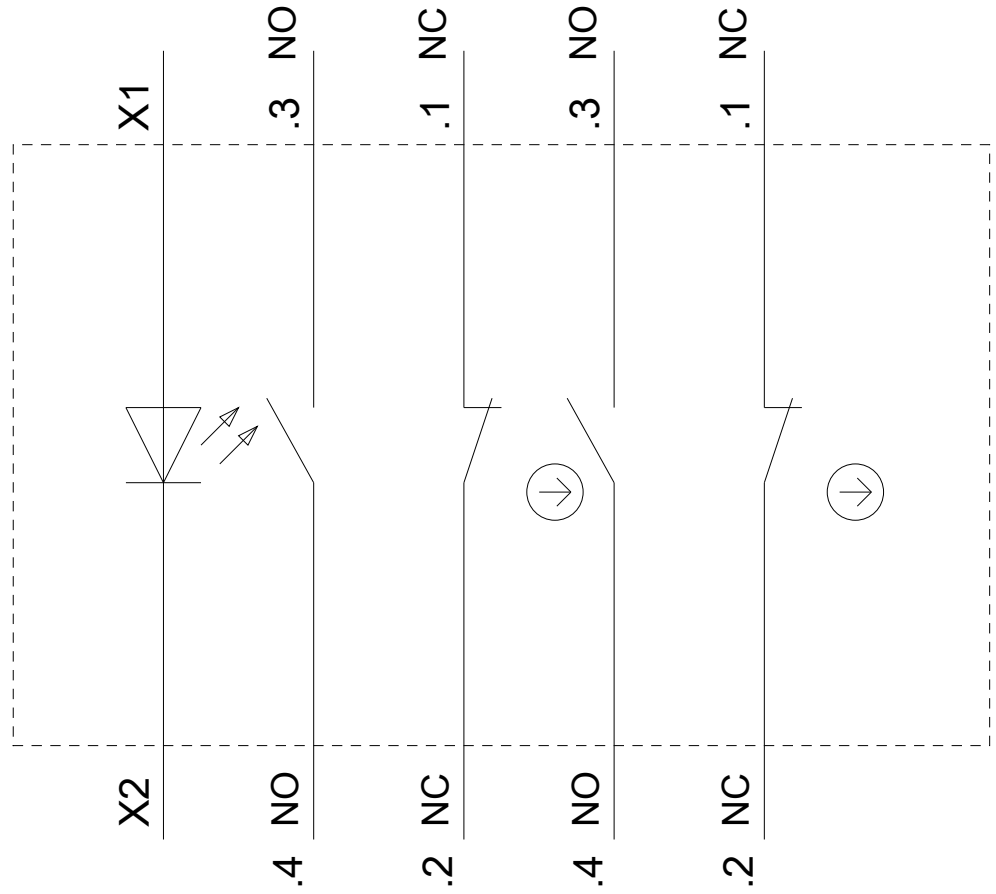

last modified:

03/08/2020