

Holder for 3 modules, plastic, 1 NO+1 NC, 1 NO+1 NC, LED module, green, 6-24 V AC/DC, screw terminal

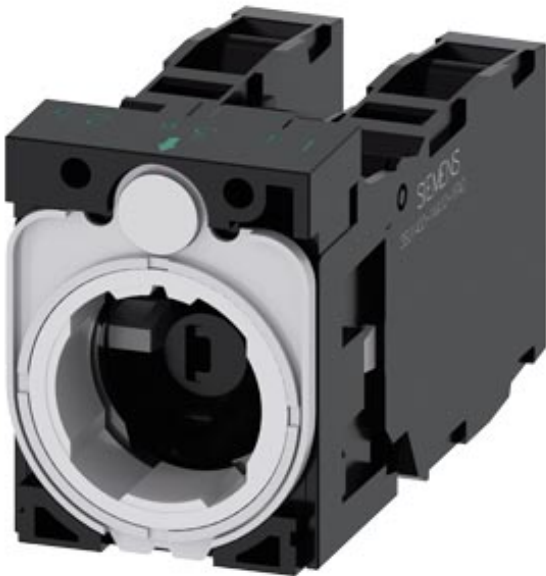

<b>Product brand name</b>	SIRIUS ACT
<b>Product designation</b>	Holders
<b>Product type designation</b>	3SU1
<b>Manufacturer's article number</b>	<ul style="list-style-type: none"> <li>• of supplied contact module 3SU1400-1AA10-1FA0, 3SU1400-1AA10-1FA0</li> <li>• 1 of supplied contact module <a href="#">3SU1400-1AA10-1FA0</a></li> <li>• 2 of supplied contact module <a href="#">3SU1400-1AA10-1FA0</a></li> <li>• of supplied LED module <a href="#">3SU1401-1BG40-1AA0</a></li> <li>• of the supplied holder <a href="#">3SU1500-0AA10-0AA0</a></li> </ul>
<b>Actuator</b>	
<b>Design of the operating mechanism</b>	3-way with module
<b>Number of contact modules</b>	2
<b>Holder</b>	
<b>Material of the holder</b>	Plastic
<b>Display</b>	
<b>Number of LED modules</b>	1
<b>General technical data</b>	

<b>Product function</b>	
• positive opening	Yes
<b>Product component</b>	
• diode	Yes
• lamp transformer	No
• Light source	Yes
• series resistor	No
<b>Insulation voltage</b>	
• rated value	320 V
<b>Degree of pollution</b>	3
<b>Surge voltage resistance rated value</b>	4 kV
<b>Protection class IP</b>	
• of the terminal	IP20
<b>Shock resistance</b>	
• acc. to IEC 60068-2-27	Sinusoidal half-wave 50 g / 11 ms
• for railway applications acc. to DIN EN 61373	Category 1, Class B
<b>Vibration resistance</b>	
• acc. to IEC 60068-2-6	10 ... 500 Hz: 5g
• for railway applications acc. to DIN EN 61373	Category 1, Class B
<b>Operating frequency maximum</b>	3 600 1/h
<b>Mechanical service life (switching cycles)</b>	
• typical	10
<b>Thermal current</b>	10 A
<b>Reference code acc. to DIN EN 81346-2</b>	U
<b>Reference code acc. to DIN EN 61346-2</b>	U
<b>Continuous current of the C characteristic MCB</b>	10 A; for a short-circuit current smaller than 400 A
<b>Continuous current of the quick DIAZED fuse link</b>	10 A
<b>Continuous current of the DIAZED fuse link gG</b>	10 A
<b>Operating voltage</b>	
• at AC	
— at 50 Hz rated value	6 ... 24 V
— at 60 Hz rated value	6 ... 24 V
• at DC	
— rated value	6 ... 24 V

## Power Electronics

<b>Contact reliability</b>	One maloperation per 100 million (17 V, 5 mA), one maloperation per 10 million (5 V, 1 mA)
----------------------------	--

## Control circuit/ Control

<b>Inrush current of LED module maximum</b>	2 A
---	-----

## Auxiliary circuit

<b>Design of the contact of auxiliary contacts</b>	Silver alloy
--	--------------

Number of NC contacts for auxiliary contacts	2
Number of NO contacts for auxiliary contacts	2
Operating current at AC-15	6 A
• at 230 V rated value	

### Connections/ Terminals

Type of electrical connection	Screw-type terminal
• of modules and accessories	
Type of connectable conductor cross-sections	2x (0.5 ... 0.75 mm <sup>2</sup> ) 2x (1.0 ... 1.5 mm <sup>2</sup> ) 2x (0.5 ... 1.5 mm <sup>2</sup> ) 2x (1,0 ... 1,5 mm <sup>2</sup> ) 2x (18 ... 14)
• solid with core end processing	
• solid without core end processing	
• finely stranded with core end processing	
• finely stranded without core end processing	
• at AWG conductors	
Tightening torque of the screws in the bracket	1 ... 1.2 N·m
Tightening torque	0.8 ... 0.9 N·m
• with screw-type terminals	

### Lamp

Type of light source	LED
Color of the light source	green
Light intensity	900 ... 1 800 mcd





### Ambient conditions

Ambient temperature	-25 ... +70 °C -40 ... +80 °C
• during operation	
• during storage	
Environmental category during operation acc. to IEC 60721	3M6, 3S2, 3B2, 3K6 (with relative air humidity of 10 ... 95 %, no condensation in operation permitted)

### Installation/ mounting/ dimensions

Mounting type	front panel mounting
• of modules and accessories	Front plate mounting
Height	40 mm
Width	30 mm
Shape of the installation opening	round
Installation width	30 mm
Installation depth	71.8 mm

### Certificates/ approvals

General Product Approval	Declaration of Conformity	Test Certificates
 CCC	 CSA	  EG-Konf.

[Miscellaneous](#)

[Type Test Certificates/Test Report](#)

Test Certificates	other
<a href="#">Special Test Certificate</a>	<a href="#">Confirmation</a>

#### Further information

**Information- and Downloadcenter (Catalogs, Brochures,...)**

<https://www.siemens.com/ic10>

**Industry Mall (Online ordering system)**

<https://mall.industry.siemens.com/mall/en/en/Catalog/product?mlfb=3SU1501-1AG40-1LA0>

**Cax online generator**

<http://support.automation.siemens.com/WW/CAXorder/default.aspx?lang=en&mlfb=3SU1501-1AG40-1LA0>

**Service&Support (Manuals, Certificates, Characteristics, FAQs,...)**

<https://support.industry.siemens.com/cs/ww/en/ps/3SU1501-1AG40-1LA0>

**Image database (product images, 2D dimension drawings, 3D models, device circuit diagrams, EPLAN macros, ...)**

[http://www.automation.siemens.com/bilddb/cax\\_de.aspx?mlfb=3SU1501-1AG40-1LA0&lang=en](http://www.automation.siemens.com/bilddb/cax_de.aspx?mlfb=3SU1501-1AG40-1LA0&lang=en)

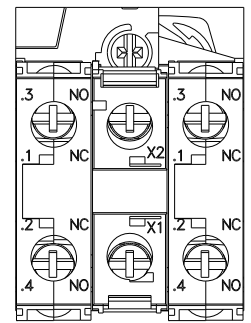
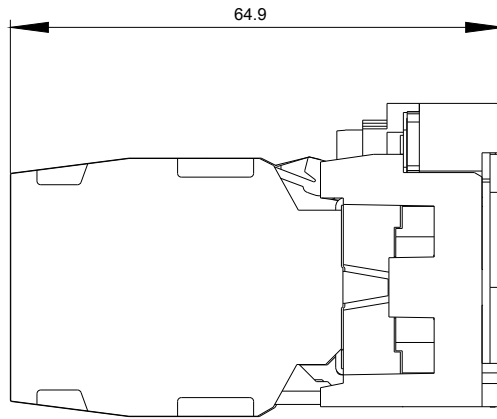
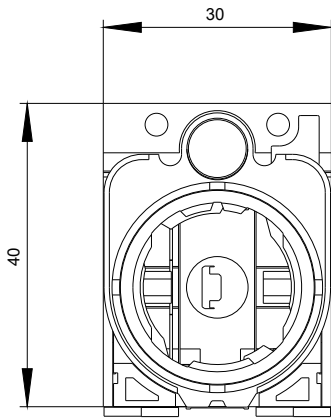

6-24 V AC/DC  $\bar{P}$

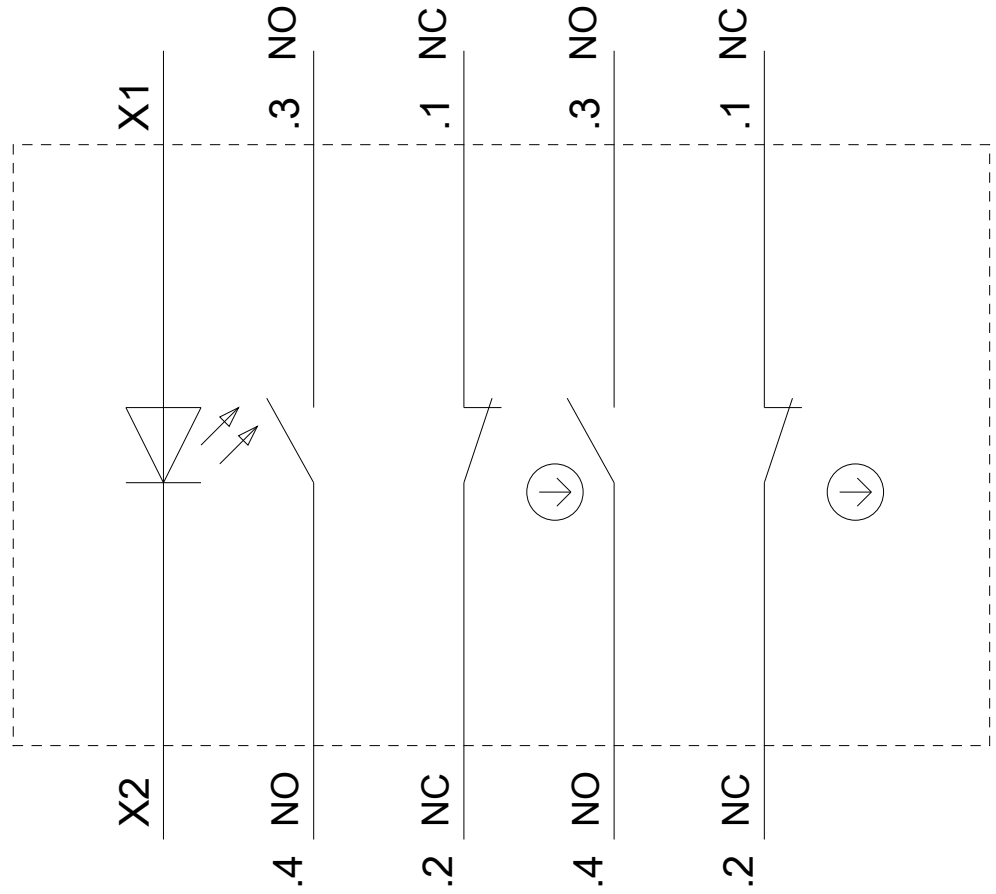

last modified:

02/18/2020