

LED module with integrated LED 24 V AC/DC, white, spring-type terminal, for floor mounting, Minimum order quantity 5 or a multiple thereof



Product brand name	SIRIUS ACT
Product designation	LED module
Product type designation	3SU1

General technical data

Product component	
<ul style="list-style-type: none"> • diode • lamp transformer • Light source • series resistor 	<p>Yes</p> <p>No</p> <p>Yes</p> <p>No</p>
Insulation voltage	
<ul style="list-style-type: none"> • rated value 	320 V
Degree of pollution	3
Type of voltage	
<ul style="list-style-type: none"> • of the operating voltage • for actuation 	<p>AC/DC</p> <p>AC/DC</p>
Surge voltage resistance rated value	4 kV
Consumed current	
<ul style="list-style-type: none"> • maximum 	20 mA
Protection class IP	

<ul style="list-style-type: none"> • of the enclosure • of the terminal 	<p>IP40</p> <p>IP20</p>
Shock resistance <ul style="list-style-type: none"> • acc. to IEC 60068-2-27 • for railway applications acc. to DIN EN 61373 	<p>Sinusoidal half-wave 50 g / 11 ms</p> <p>Category 1, Class B</p>
Vibration resistance <ul style="list-style-type: none"> • acc. to IEC 60068-2-6 • for railway applications acc. to DIN EN 61373 	<p>10 ... 500 Hz: 5g</p> <p>Category 1, Class B</p>
Operating period typical	100 000 h
Reference code acc. to DIN EN 81346-2	P
Reference code acc. to DIN EN 61346-2	P
Operating voltage 1 <ul style="list-style-type: none"> • at AC <ul style="list-style-type: none"> — at 50 Hz rated value — at 60 Hz rated value • at DC rated value 	<p>24 V</p> <p>24 V</p> <p>24 V</p>
Relative positive tolerance of the operating voltage	20 %
Relative negative tolerance of the operating voltage	20 %

Control circuit/ Control	
Inrush current maximum	2 A

Connections/ Terminals	
Type of electrical connection	spring-loaded terminals
Type of connectable conductor cross-sections <ul style="list-style-type: none"> • solid without core end processing • finely stranded with core end processing • finely stranded without core end processing • at AWG conductors 	<p>2x (0.25 ... 1.5 mm²)</p> <p>2x (0.25 ... 0.75 mm²)</p> <p>2x (0.25 ... 1.5 mm²)</p> <p>2x (24 ... 16)</p>

Lamp	
Type of light source	LED
Color of the light source	white
Light intensity	900 ... 1 400 mcd
Certificate of suitability <ul style="list-style-type: none"> • ATEX • IECEx 	<p>No</p> <p>No</p>



Ambient conditions	
Ambient temperature <ul style="list-style-type: none"> • during operation • during storage 	<p>-25 ... +70 °C</p> <p>-40 ... +80 °C</p>
Environmental category during operation acc. to IEC 60721	3M6, 3S2, 3B2, 3C3, 3K6 (with relative air humidity of 10 ... 95 %, no condensation in operation permitted)



Installation/ mounting/ dimensions

Mounting type	Floor mounting
<ul style="list-style-type: none"> • of modules and accessories 	
Height	36 mm
Width	9.8 mm
Depth	29.4 mm

Certificates/ approvals

General Product Approval	EMC	Declaration of Conformity
 CCC	 UL	 EG-Konf.
 CSA	 EAC	 RCM

Declaration of Conformity	Test Certificates	Marine / Shipping
Miscellaneous	Special Test Certificate	 ABS
	Type Test Certificates/Test Report	 LRS
		 PRS

Marine / Shipping	other
 RINA	 DNV-GL DNVGL.COM/AF
 RMRS	Confirmation

Further information

Information- and Downloadcenter (Catalogs, Brochures,...)

<https://www.siemens.com/ic10>

Industry Mall (Online ordering system)

<https://mall.industry.siemens.com/mall/en/en/Catalog/product?mfb=3SU1401-2BB60-3AA0>

Cax online generator

<http://support.automation.siemens.com/WW/CAXorder/default.aspx?lang=en&mfb=3SU1401-2BB60-3AA0>

Service&Support (Manuals, Certificates, Characteristics, FAQs,...)

<https://support.industry.siemens.com/cs/ww/en/ps/3SU1401-2BB60-3AA0>

Image database (product images, 2D dimension drawings, 3D models, device circuit diagrams, EPLAN macros, ...)

http://www.automation.siemens.com/bilddb/cax_de.aspx?mfb=3SU1401-2BB60-3AA0&lang=en

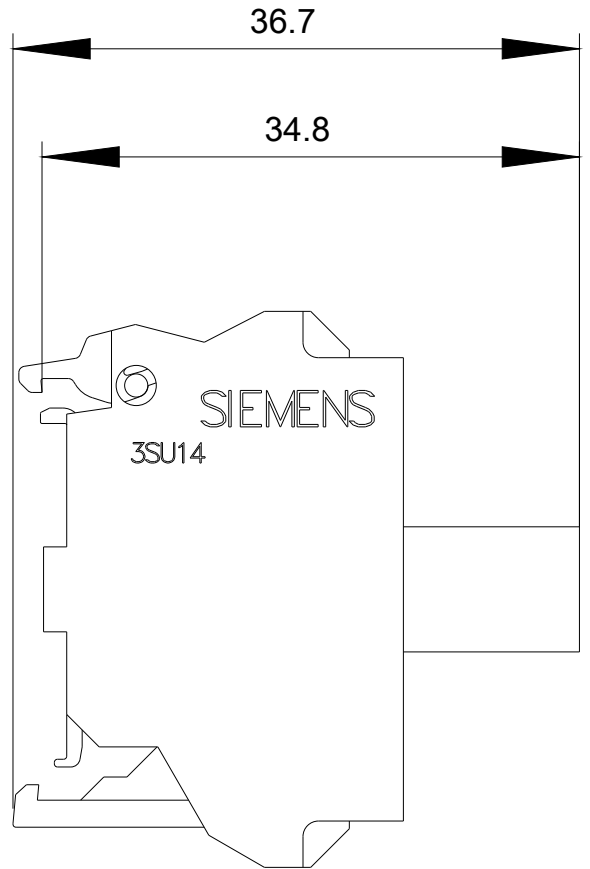
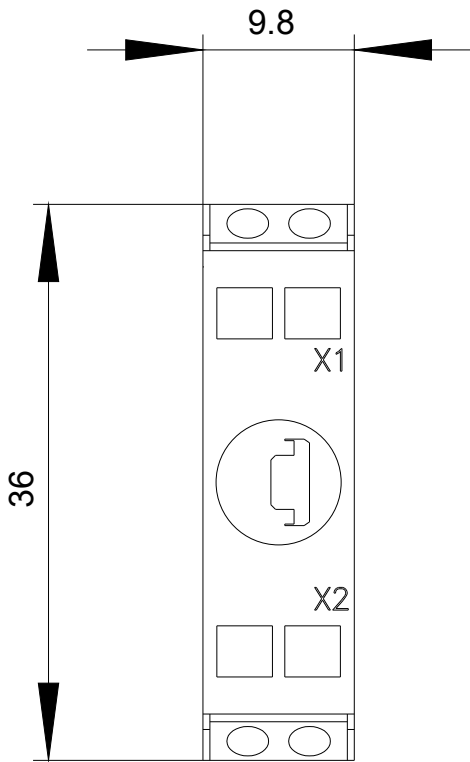

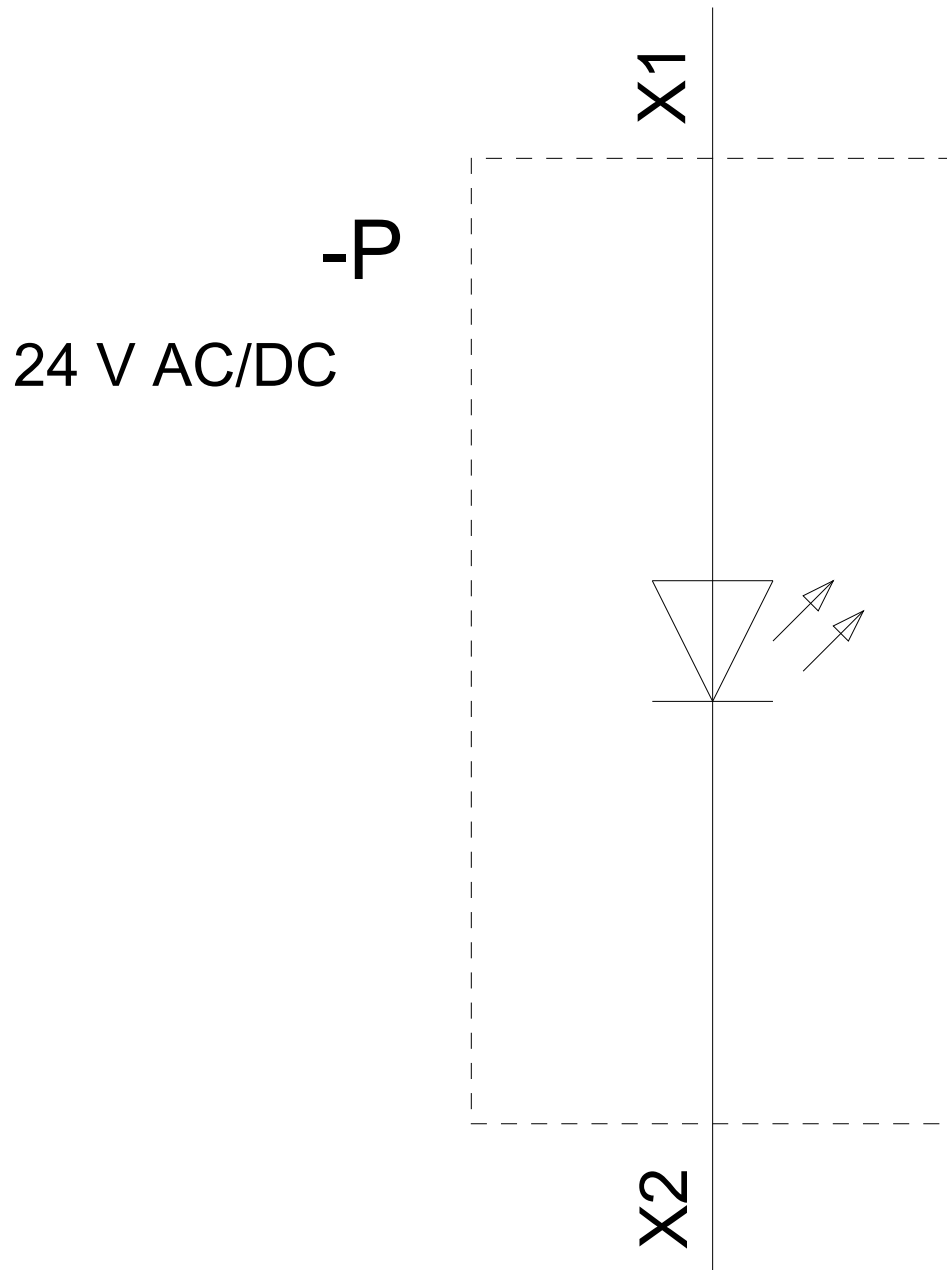

last modified:

03/10/2020