

LED module with integrated LED 24 V AC/DC, amber, screw-type terminal, for floor mounting, Minimum order quantity 5 or a multiple thereof



Product brand name	SIRIUS ACT
Product designation	LED module
Product type designation	3SU1

**General technical data**

<b>Product component</b>	
• diode	Yes
• lamp transformer	No
• Light source	Yes
• series resistor	No
<b>Insulation voltage</b>	
• rated value	320 V
<b>Degree of pollution</b>	3
<b>Type of voltage</b>	
• of the operating voltage	AC/DC
• for actuation	AC/DC
<b>Surge voltage resistance rated value</b>	4 kV
<b>Consumed current</b>	
• maximum	20 mA
<b>Protection class IP</b>	

<ul style="list-style-type: none"> <li>• of the enclosure</li> <li>• of the terminal</li> </ul>	<p>IP40</p> <p>IP20</p>
<b>Shock resistance</b> <ul style="list-style-type: none"> <li>• acc. to IEC 60068-2-27</li> <li>• for railway applications acc. to DIN EN 61373</li> </ul>	<p>Sinusoidal half-wave 50 g / 11 ms</p> <p>Category 1, Class B</p>
<b>Vibration resistance</b> <ul style="list-style-type: none"> <li>• acc. to IEC 60068-2-6</li> <li>• for railway applications acc. to DIN EN 61373</li> </ul>	<p>10 ... 500 Hz: 5g</p> <p>Category 1, Class B</p>
<b>Operating period typical</b>	100 000 h
<b>Reference code acc. to DIN EN 81346-2</b>	P
<b>Reference code acc. to DIN EN 61346-2</b>	P
<b>Operating voltage 1</b> <ul style="list-style-type: none"> <li>• at AC <ul style="list-style-type: none"> <li>— at 50 Hz rated value</li> <li>— at 60 Hz rated value</li> </ul> </li> <li>• at DC rated value</li> </ul>	<p>24 V</p> <p>24 V</p> <p>24 V</p>
<b>Relative positive tolerance of the operating voltage</b>	20 %
<b>Relative negative tolerance of the operating voltage</b>	20 %

#### Control circuit/ Control

<b>Inrush current maximum</b>	2 A
-------------------------------	-----

#### Connections/ Terminals

<b>Type of electrical connection</b>	screw-type terminals
<b>Type of connectable conductor cross-sections</b> <ul style="list-style-type: none"> <li>• solid with core end processing</li> <li>• solid without core end processing</li> <li>• finely stranded with core end processing</li> <li>• finely stranded without core end processing</li> <li>• at AWG conductors</li> </ul>	<p>2x (0.5 ... 0.75 mm<sup>2</sup>)</p> <p>2x (1.0 ... 1.5 mm<sup>2</sup>)</p> <p>2x (0.5 ... 1.5 mm<sup>2</sup>)</p> <p>2x (1,0 ... 1,5 mm<sup>2</sup>)</p> <p>2x (18 ... 14)</p>
<b>Tightening torque</b> <ul style="list-style-type: none"> <li>• with screw-type terminals</li> </ul>	0.8 ... 0.9 N·m

#### Lamp

<b>Type of light source</b>	LED
<b>Color of the light source</b>	amber
<b>Light intensity</b>	450 ... 1 120 mcd
<b>Certificate of suitability</b> <ul style="list-style-type: none"> <li>• ATEX</li> <li>• IECEx</li> </ul>	<p>No</p> <p>No</p>

#### Ambient conditions





<b>Ambient temperature</b> <ul style="list-style-type: none"> <li>• during operation</li> <li>• during storage</li> </ul>	<p>-25 ... +70 °C</p> <p>-40 ... +80 °C</p>
---	---

Environmental category during operation acc. to IEC 60721	3M6, 3S2, 3B2, 3C3, 3K6 (with relative air humidity of 10 ... 95 %, no condensation in operation permitted)
---	---

### Installation/ mounting/ dimensions

<b>Mounting type</b>	Floor mounting
• of modules and accessories	
<b>Height</b>	33.2 mm
<b>Width</b>	9.8 mm
<b>Depth</b>	29.4 mm

### Certificates/ approvals

General Product Approval	Declaration of Conformity	Test Certificates
 CCC	 UL	 EAC
	 EG-Konf.	<a href="#">Miscellaneous</a> <a href="#">Special Test Certificate</a>

Test Certificates	Marine / Shipping
<a href="#">Type Test Certificates/Test Report</a>	 ABS  LRS  PRS  RINA  RMRS

Marine / Shipping	other
 DNV-GL DNVGL.COM/AF	<a href="#">Confirmation</a>

### Further information

**Information- and Downloadcenter (Catalogs, Brochures,...)**

<https://www.siemens.com/ic10>

**Industry Mall (Online ordering system)**

<https://mall.industry.siemens.com/mall/en/en/Catalog/product?mlfb=3SU1401-2BB00-1AA0>

**Cax online generator**

<http://support.automation.siemens.com/WW/CAXorder/default.aspx?lang=en&mlfb=3SU1401-2BB00-1AA0>

**Service&Support (Manuals, Certificates, Characteristics, FAQs,...)**

<https://support.industry.siemens.com/cs/ww/en/ps/3SU1401-2BB00-1AA0>

**Image database (product images, 2D dimension drawings, 3D models, device circuit diagrams, EPLAN macros, ...)**

[http://www.automation.siemens.com/bilddb/cax\\_de.aspx?mlfb=3SU1401-2BB00-1AA0&lang=en](http://www.automation.siemens.com/bilddb/cax_de.aspx?mlfb=3SU1401-2BB00-1AA0&lang=en)

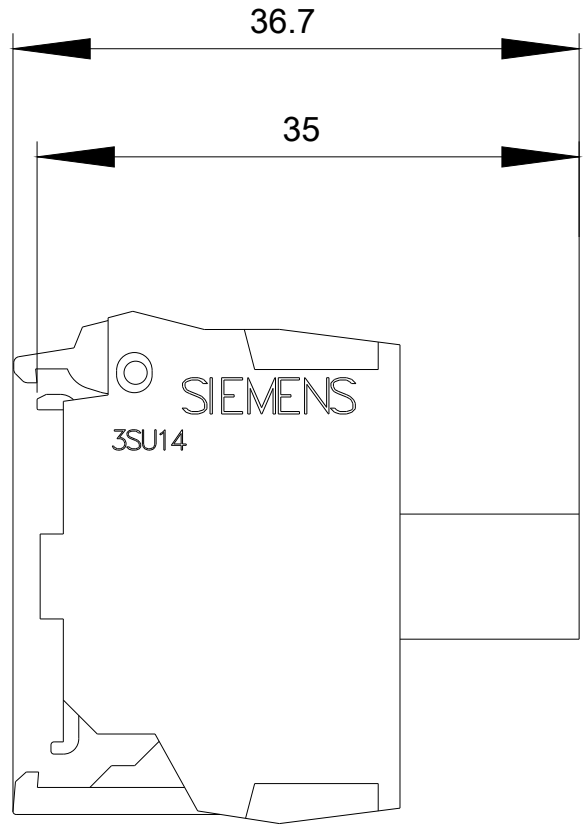
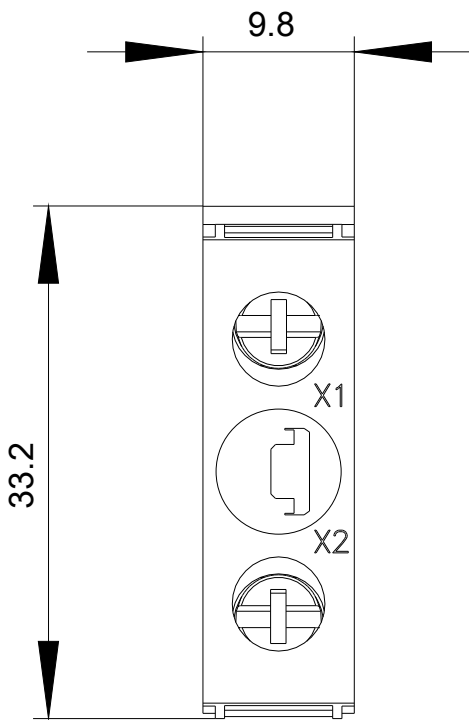

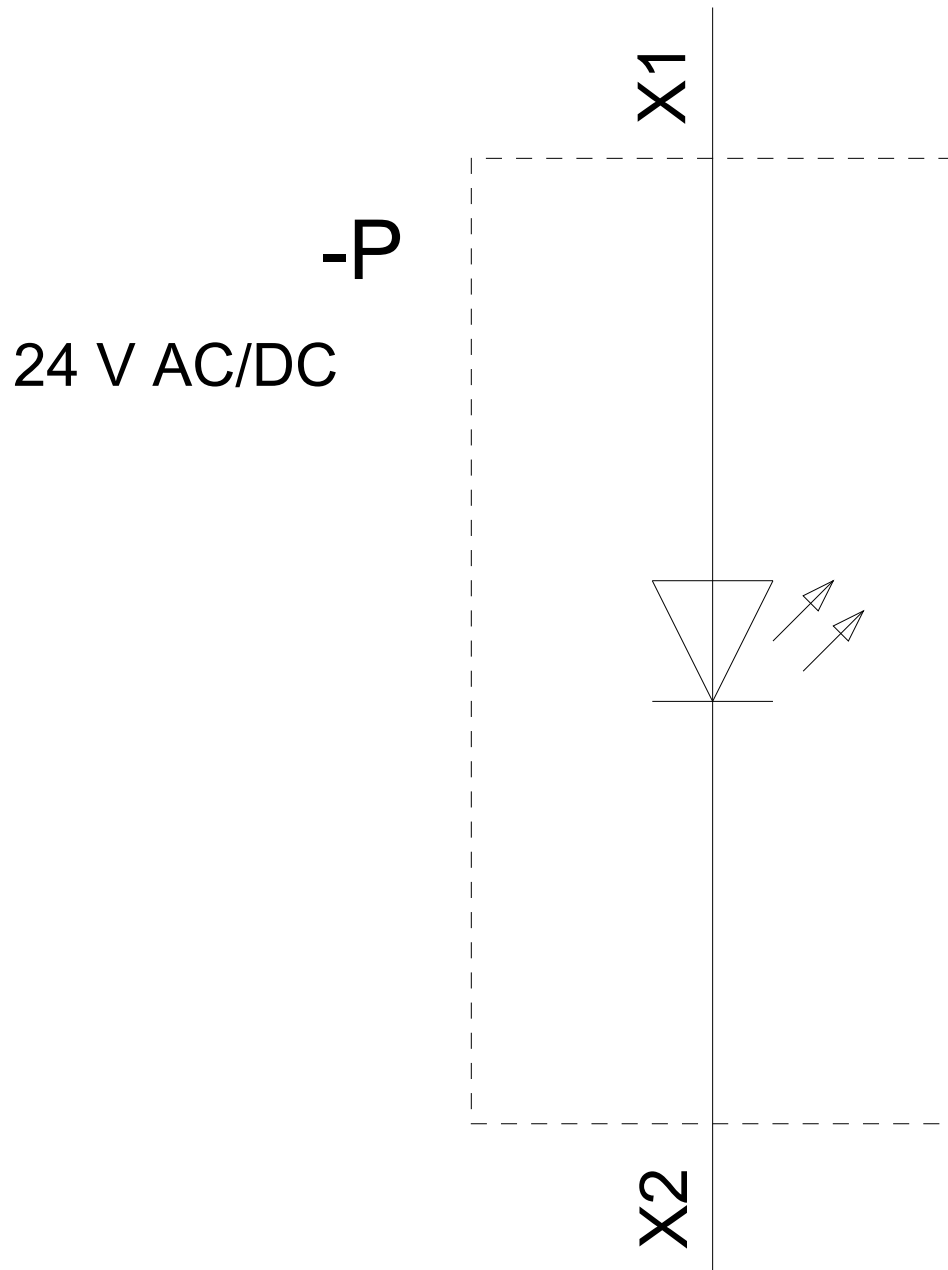

last modified:

03/10/2020