

Support terminal, blue, spring-type terminal, for floor mounting



Product brand name	SIRIUS ACT
Product designation	Support terminal
Product type designation	3SU1

General technical data

Suitability for integration	yes
Degree of pollution	3
Surge voltage resistance rated value	6 kV
Protection class IP	
• of the enclosure	IP40
• of the terminal	IP20
Reference code acc. to DIN EN 81346-2	S
Reference code acc. to DIN EN 61346-2	S

Connections/ Terminals

Type of electrical connection	spring-loaded terminals
• of modules and accessories	Spring-type terminal

Ambient conditions

Ambient temperature	
• during operation	-25 ... +70 °C





- during storage





-40 ... +80 °C

Installation/ mounting/ dimensions

Mounting type	
<ul style="list-style-type: none"> • of modules and accessories 	Floor mounting
Height	36 mm
Width	9.8 mm
Depth	33.6 mm

Certificates/ approvals

General Product Approval	Declaration of Conformity	Test Certificates	Marine / Shipping
 UL	 EAC	 EG-Konf.	Miscellaneous Type Test Certificates/Test Report  ABS

Marine / Shipping	other
 LRS  PRS  RINA  RMRS  DNV-GL DNVGL.COM/AF	Confirmation

Further information

Information- and Downloadcenter (Catalogs, Brochures,...)

<https://www.siemens.com/ic10>

Industry Mall (Online ordering system)

<https://mall.industry.siemens.com/mall/en/en/Catalog/product?mfb=3SU1400-2DA50-3AA0>

Cax online generator

<http://support.automation.siemens.com/WW/CAXorder/default.aspx?lang=en&mfb=3SU1400-2DA50-3AA0>

Service&Support (Manuals, Certificates, Characteristics, FAQs,...)

<https://support.industry.siemens.com/cs/ww/en/ps/3SU1400-2DA50-3AA0>

Image database (product images, 2D dimension drawings, 3D models, device circuit diagrams, EPLAN macros, ...)

http://www.automation.siemens.com/bilddb/cax_de.aspx?mfb=3SU1400-2DA50-3AA0&lang=en

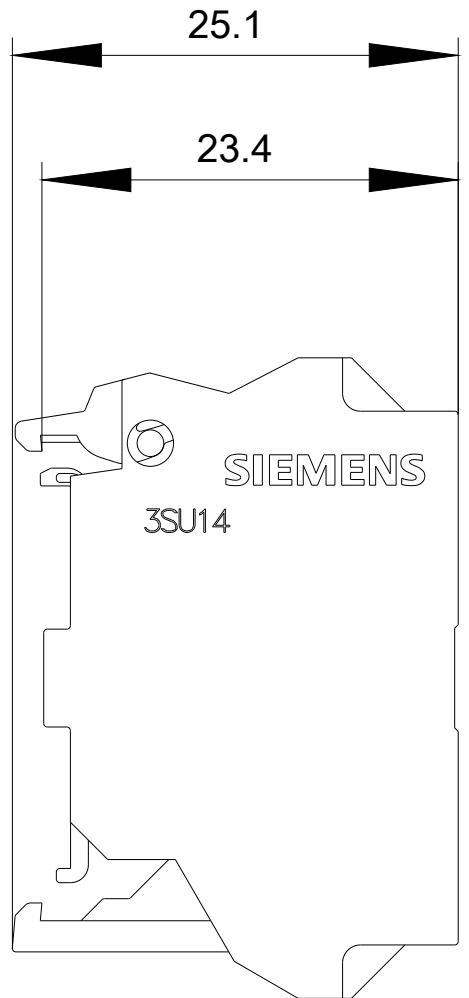
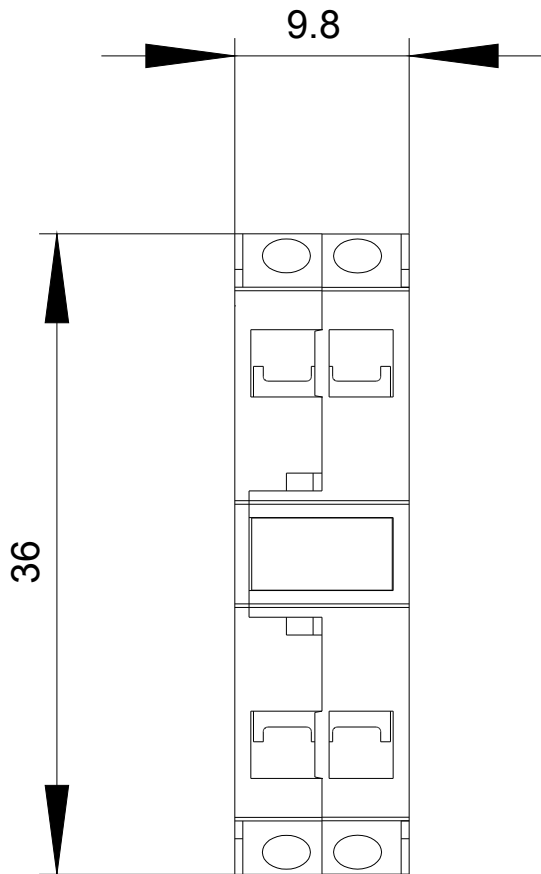

last modified:

02/22/2020