

Support terminal, blue, screw terminal, for floor mounting



Product brand name	SIRIUS ACT
Product designation	Support terminal
Product type designation	3SU1

General technical data

Suitability for integration	yes
Degree of pollution	3
Surge voltage resistance rated value	6 kV
Protection class IP	
• of the enclosure	IP40
• of the terminal	IP20
Reference code acc. to DIN EN 81346-2	S
Reference code acc. to DIN EN 61346-2	S

Connections/ Terminals

Type of electrical connection	screw-type terminals
• of modules and accessories	Screw-type terminal

Ambient conditions

Ambient temperature	
• during operation	-25 ... +70 °C





- during storage





-40 ... +80 °C

Installation/ mounting/ dimensions

Mounting type	Floor mounting
• of modules and accessories	
Height	33.2 mm
Width	9.8 mm
Depth	33.6 mm

Certificates/ approvals

General Product Approval	Declaration of Conformity	Test Certificates	Marine / Shipping
 UL	 EAC	 EG-Konf.	 ABS
	Miscellaneous	Type Test Certificates/Test Report	

Marine / Shipping	other
 LRS  PRS  RINA  RMRS  DNV-GL DNVGL.COM/AF	Confirmation

Further information

Information- and Downloadcenter (Catalogs, Brochures,...)

<https://www.siemens.com/ic10>

Industry Mall (Online ordering system)

<https://mall.industry.siemens.com/mall/en/en/Catalog/product?mfb=3SU1400-2DA50-1AA0>

Cax online generator

<http://support.automation.siemens.com/WW/CAXorder/default.aspx?lang=en&mfb=3SU1400-2DA50-1AA0>

Service&Support (Manuals, Certificates, Characteristics, FAQs,...)

<https://support.industry.siemens.com/cs/ww/en/ps/3SU1400-2DA50-1AA0>

Image database (product images, 2D dimension drawings, 3D models, device circuit diagrams, EPLAN macros, ...)

http://www.automation.siemens.com/bilddb/cax_de.aspx?mfb=3SU1400-2DA50-1AA0&lang=en

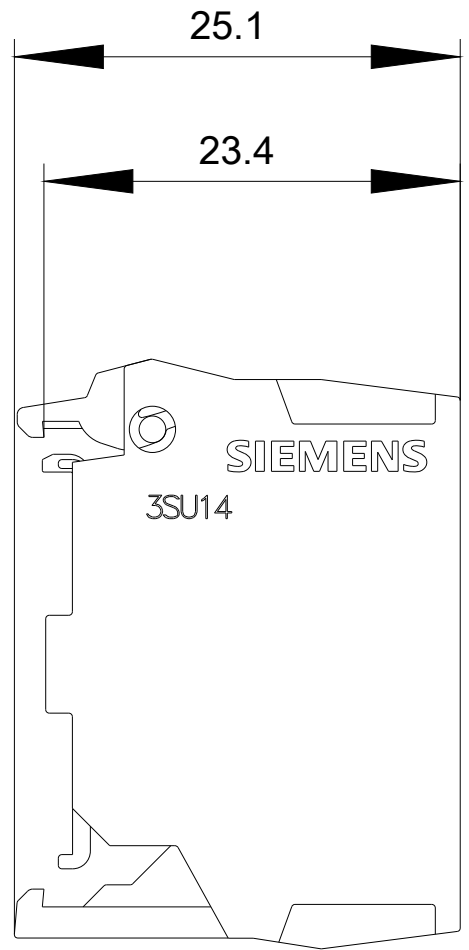
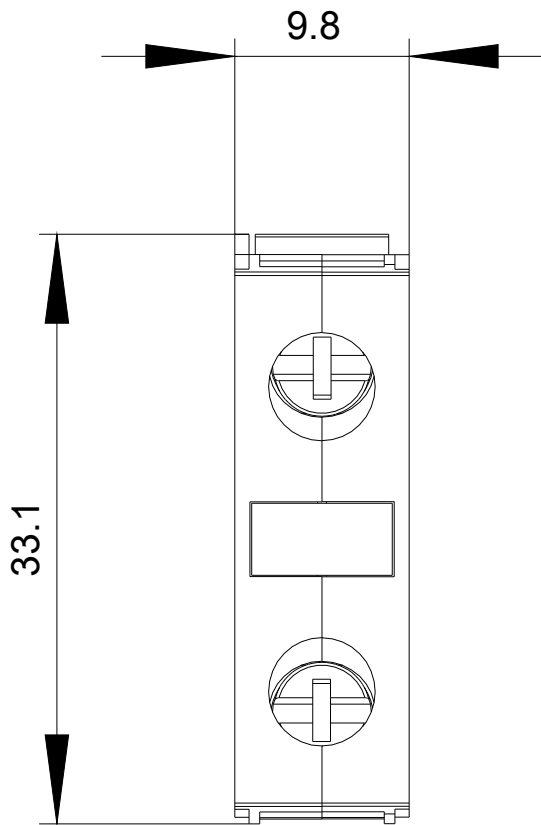

last modified:

03/05/2020