

AS-Interface module, 2 safe inputs, black, insulation displacement system, for front plate mounting



Product brand name	SIRIUS ACT
Product designation	AS-Interface module
Product type designation	3SU1
General technical data	
Product function	2F-DI
Degree of pollution	3
Type of voltage	
• of the operating voltage	DC
• of the input voltage	DC
Consumed current	
• maximum	60 mA
Protection class IP	IP20
Shock resistance	
• for railway applications acc. to DIN EN 61373	Category 1, Class B
Vibration resistance	
• for railway applications acc. to DIN EN 61373	Category 1, Class B
Reference code acc. to DIN 40719 extended according to IEC 204-2 acc. to IEC 750	A
Reference code acc. to DIN EN 81346-2	K

Reference code acc. to DIN EN 61346-2	K
Design of the slave type	2 F-DI
AS interface slave profile	S-0.B.F
ID1 code	1...F
Number of AS-i slaves	1
Protocol is supported ASIsafe (Safety at work) protocol	Yes
Operating voltage	
• rated value	26.5 ... 31.6 V
Operating voltage 1	
• at DC rated value	30 V

Communication/ Protocol

Protocol is supported	
• AS-Interface protocol	Yes

Inputs/ Outputs

Number of digital inputs	
• safety-related	2

Connections/ Terminals

Type of electrical connection	Insulation displacement method
--------------------------------------	--------------------------------

Product Function

Suitability for use	
• safety-related circuits	Yes

Safety related data

Safety Integrity Level (SIL) acc. to IEC 61508	3
SIL Claim Limit (subsystem) acc. to EN 62061	SILCL 3
Performance level (PL) acc. to EN ISO 13849-1	e
Safe failure fraction (SFF)	99 %
Average diagnostic coverage level (DCavg)	99 %
PFHD with high demand rate acc. to EN 62061	0.0000000045 1/h
PFDAvg with low demand rate acc. to IEC 61508	0.000005
Category acc. to EN 954-1	4

Ambient conditions

Ambient temperature	
• during operation	-25 ... +70 °C
• during storage	-40 ... +80 °C
Environmental category during operation acc. to IEC 60721	3M6, 3S2, 3B2, 3C3 (without salt spray), 3K6 (with relative humidity of 10 ... 95%, no condensation in operation permitted)

Installation/ mounting/ dimensions





Mounting type	
• of modules and accessories	Front plate mounting

- of AS-i slaves

Frontplattenbefestigung

Height	42 mm
Width	30 mm
Depth	65.5 mm

Certificates/ approvals

General Product Approval	EMC	Functional Safety/Safety of Machinery	Declaration of Conformity
 UL		 RCM	 EG-Konf.

[Type Examination Certificate](#)

[Miscellaneous](#)

Test Certificates	other
Type Test Certificates/Test Report	Special Test Certificate



ASi

[Confirmation](#)

Further information

Information- and Downloadcenter (Catalogs, Brochures,...)

<https://www.siemens.com/ic10>

Industry Mall (Online ordering system)

<https://mall.industry.siemens.com/mall/en/en/Catalog/product?mlfb=3SU1400-1EA10-4AA0>

Cax online generator

<http://support.automation.siemens.com/WW/CAXorder/default.aspx?lang=en&mlfb=3SU1400-1EA10-4AA0>

Service&Support (Manuals, Certificates, Characteristics, FAQs,...)

<https://support.industry.siemens.com/cs/ww/en/ps/3SU1400-1EA10-4AA0>

Image database (product images, 2D dimension drawings, 3D models, device circuit diagrams, EPLAN macros, ...)

http://www.automation.siemens.com/bilddb/cax_de.aspx?mlfb=3SU1400-1EA10-4AA0&lang=en

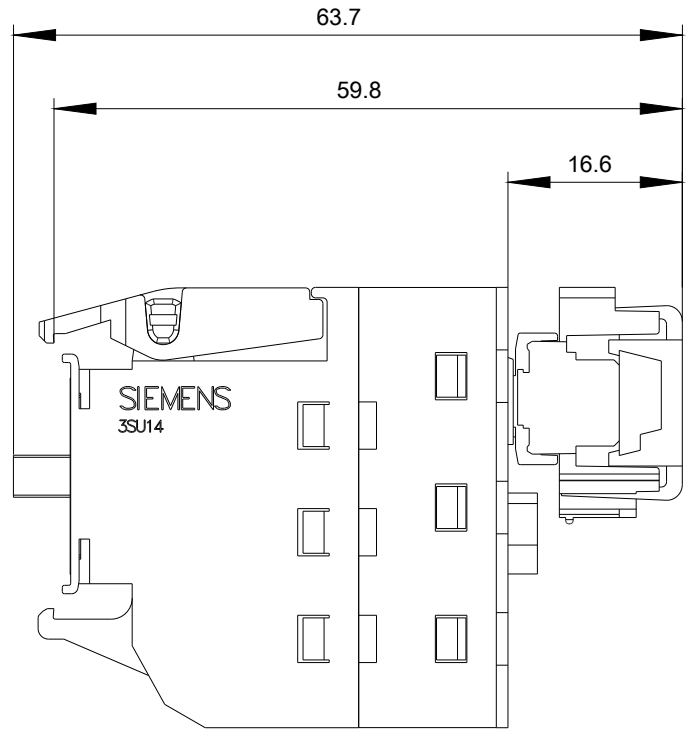
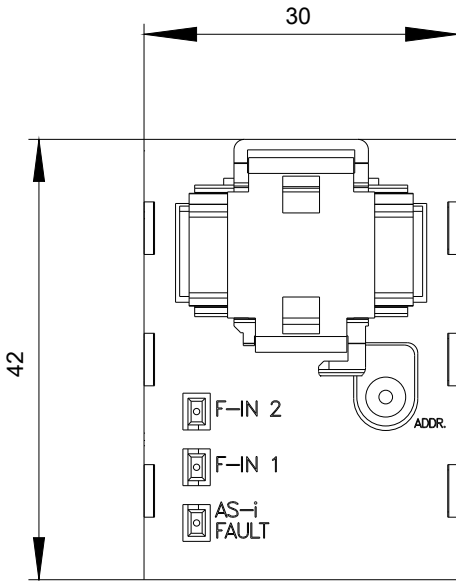

-K1

AS-i Bus:
Slave:

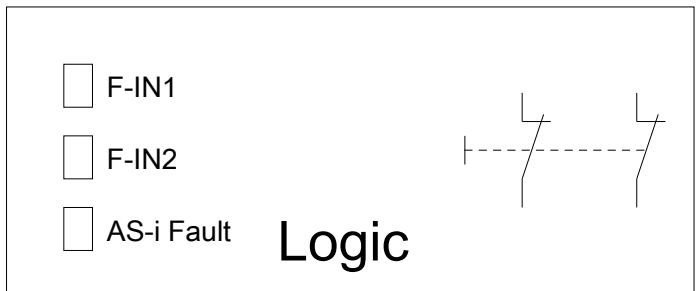

AS-i+

ADDR

last modified:

03/10/2020