

acoustic signal device, compact, 22 mm, round, Metal, black, Continuous tone 2.4 kHz, IP40, Sound pressure min. 80 dB/10 cm, with holder, Operating voltage 24 V AC/DC, screw terminal



Product brand name	SIRIUS ACT
Product designation	Acoustic signaling device
Design of the product	Compact unit
Product type designation	3SU1
Product line	Metal, shiny, 22 mm
Manufacturer's article number	
• of the supplied holder	3SU1550-0AA10-0AA0

Enclosure

Number of command points	1
--------------------------	---

Actuator

Color	
• of the actuating element	black
Material of the actuating element	plastic
Shape of the actuating element	round
Outer diameter of the actuating element	29.5 mm

Front ring

Product component front ring	No
------------------------------	----

Holder

Material of the holder	Metal
General technical data	
Loudness level at 10 cm distance	80 dB
Insulation voltage	
• rated value	320 V
Degree of pollution	3
Surge voltage resistance rated value	4 kV
Consumed current	
• at rated value of operating voltage maximum	28 mA
Protection class IP	IP40
• of the terminal	IP20
Degree of protection NEMA rating	1
Shock resistance	
• acc. to IEC 60068-2-27	Sinusoidal half-wave 50 g / 11 ms
Vibration resistance	
• acc. to IEC 60068-2-6	10 ... 500 Hz: 5g
Reference code acc. to DIN EN 81346-2	P
Reference code acc. to DIN EN 61346-2	P
Relative positive tolerance of the operating voltage	20 %
Relative negative tolerance of the operating voltage	20 %
Supply voltage	
Type of voltage of the supply voltage	
• of the acoustic signal element	AC/DC
Supply voltage at AC	
• at 50 Hz rated value	24 V
• at 60 Hz rated value	24 V
Supply voltage at DC rated value	24 V
Control circuit/ Control	
Inrush current maximum	2 A
Connections/ Terminals	
Type of electrical connection	screw-type terminals
Type of connectable conductor cross-sections	
• solid with core end processing	2x (0.5 ... 0.75 mm ²)
• solid without core end processing	2x (1.0 ... 1.5 mm ²)
• finely stranded with core end processing	2x (0.5 ... 1.5 mm ²)
• finely stranded without core end processing	2x (1,0 ... 1,5 mm ²)
• at AWG conductors	2x (18 ... 14)
Tightening torque of the screws in the bracket	1 ... 1.2 N·m
Tightening torque	
• with screw-type terminals	0.8 ... 1 N·m





Ambient conditions

Ambient temperature	
• during operation	-25 ... +70 °C
• during storage	-40 ... +80 °C
Environmental category during operation acc. to IEC 60721	3M6, 3S2, 3B2, 3K6 (with relative air humidity of 10 ... 95 %, no condensation in operation permitted for all devices behind front panel)

Installation/ mounting/ dimensions

Mounting type	front panel mounting
Height	40 mm
Width	30 mm
Shape of the installation opening	round
Mounting diameter	22.3 mm
Positive tolerance of installation diameter	0.4 mm
Mounting height	11.4 mm
Installation width	29.5 mm
Installation depth	49.6 mm

Certificates/ approvals

General Product Approval	Declaration of Conformity	Test Certificates
 CSA	 UL	
	 EG-Konf.	Miscellaneous Type Test Certificates/Test Report

Test Certificates	other
Special Test Certificate	Confirmation

Further information

Information- and Downloadcenter (Catalogs, Brochures,...)

<https://www.siemens.com/ic10>

Industry Mall (Online ordering system)

<https://mall.industry.siemens.com/mall/en/en/Catalog/product?mlfb=3SU1250-6KB10-1AA0>

Cax online generator

<http://support.automation.siemens.com/WW/CAXorder/default.aspx?lang=en&mlfb=3SU1250-6KB10-1AA0>

Service&Support (Manuals, Certificates, Characteristics, FAQs,...)

<https://support.industry.siemens.com/cs/ww/en/ps/3SU1250-6KB10-1AA0>

Image database (product images, 2D dimension drawings, 3D models, device circuit diagrams, EPLAN macros, ...)

http://www.automation.siemens.com/bilddb/cax_de.aspx?mlfb=3SU1250-6KB10-1AA0&lang=en

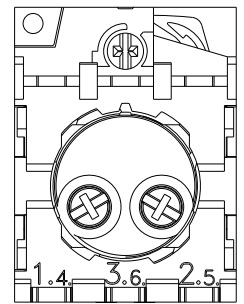
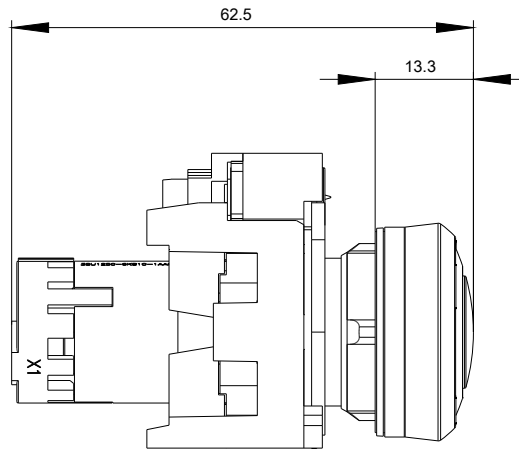
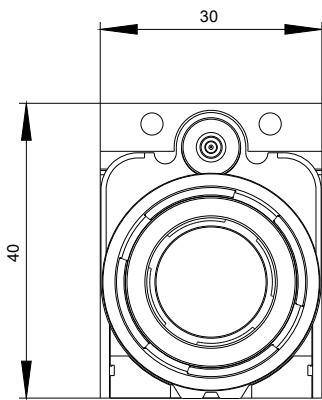

24 V AC/DC
-P

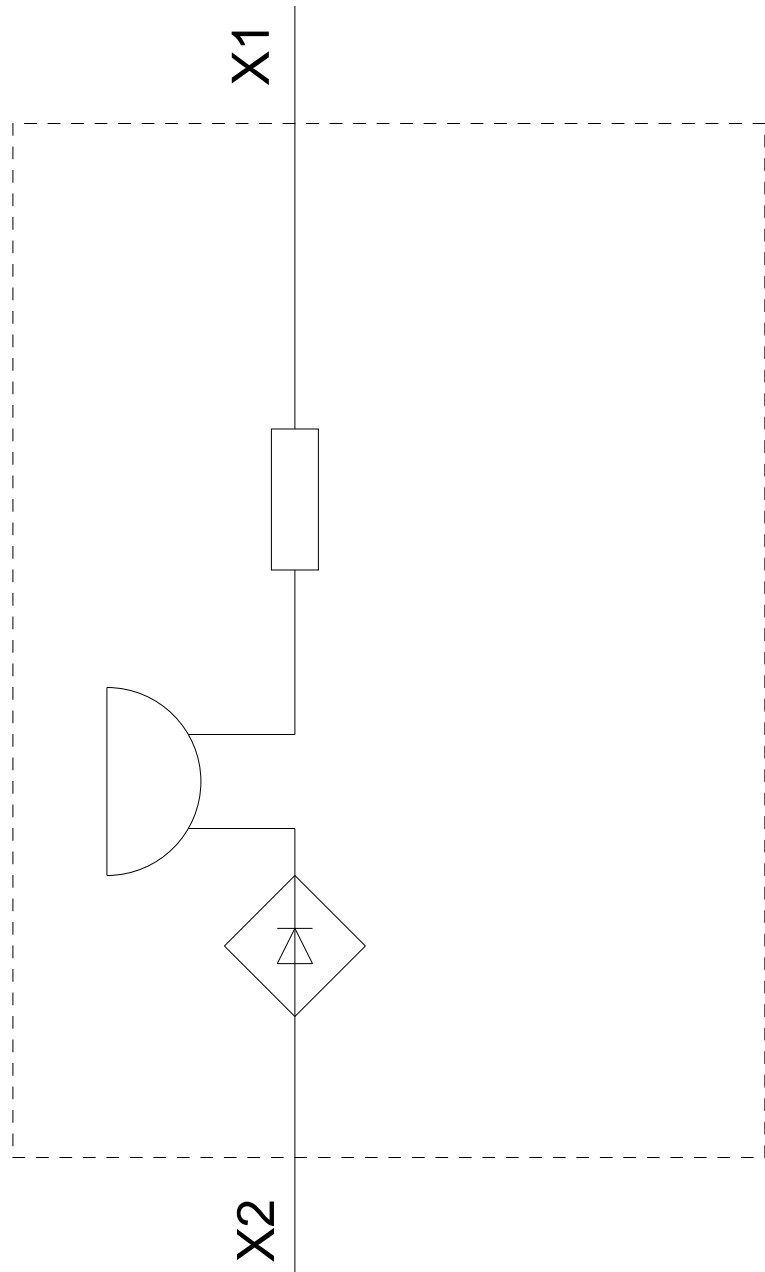

last modified:

03/03/2020