

Illuminated pushbutton, 22 mm, round, metal, shiny, red, pushbutton, flat, momentary contact type, with holder, 1 NC, LED module with integrated LED 110 V AC, screw terminal

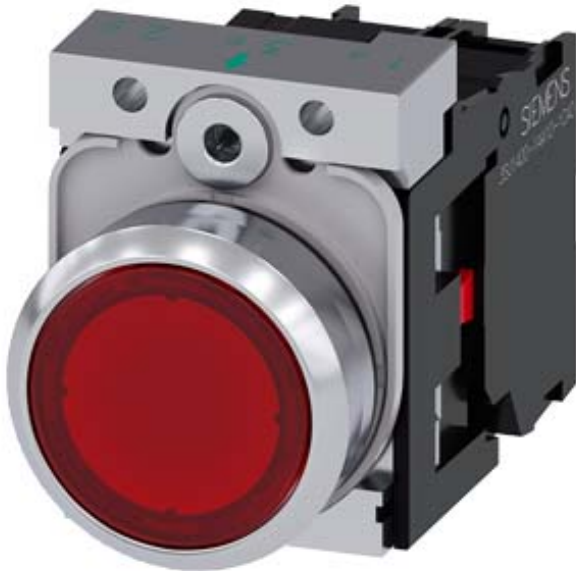

<b>Product brand name</b>	SIRIUS ACT
<b>Product designation</b>	Illuminated pushbuttons
<b>Design of the product</b>	Complete unit
<b>Product type designation</b>	3SU1
<b>Product line</b>	Metal, shiny, 22 mm
<b>Manufacturer's article number</b>	
<ul style="list-style-type: none"> <li>• 1 of supplied contact module</li> <li>• of supplied LED module</li> <li>• of the supplied holder</li> <li>• of the supplied actuator</li> </ul>	<a href="#">3SU1400-1AA10-1CA0</a> <a href="#">3SU1401-1BC20-1AA0</a> <a href="#">3SU1550-0AA10-0AA0</a> <a href="#">3SU1051-0AB20-0AA0</a>
<b>Number of command points</b>	1

Actuator	
<b>Design of the operating mechanism</b>	Button, flat
<b>Manner of function of the actuating element</b>	momentary contact type
<b>Product extension optional Light source</b>	Yes
<b>Color</b>	
<ul style="list-style-type: none"> <li>• of the actuating element</li> </ul>	red
<b>Material of the actuating element</b>	plastic
<b>Shape of the actuating element</b>	round

Outer diameter of the actuating element	29.45 mm
Number of contact modules	1
<b>Front ring</b>	
Product component front ring	Yes
Design of the front ring	Standard
Material of the front ring	Metal, high gloss
Color of the front ring	silver
<b>Holder</b>	
Material of the holder	Metal
<b>Display</b>	
Number of LED modules	1
<b>General technical data</b>	
<b>Product function</b>	
• positive opening	Yes
<b>Product component</b>	
• Light source	Yes
<b>Insulation voltage</b>	
• rated value	320 V
<b>Degree of pollution</b>	3
<b>Type of voltage</b>	
• of the operating voltage	AC/DC
<b>Surge voltage resistance rated value</b>	4 kV
<b>Protection class IP</b>	IP66, IP67, IP69(IP69K)
• of the terminal	IP20
<b>Degree of protection NEMA rating</b>	1, 2, 3, 3R, 4, 4X, 12, 13
<b>Shock resistance</b>	
• acc. to IEC 60068-2-27	Sinusoidal half-wave 50 g / 11 ms
<b>Vibration resistance</b>	
• acc. to IEC 60068-2-6	10 ... 500 Hz: 5g
<b>Operating frequency maximum</b>	3 600 1/h
<b>Mechanical service life (switching cycles)</b>	
• typical	3 000 000
<b>Electrical endurance (switching cycles)</b>	
• typical	10 000 000
<b>Thermal current</b>	10 A
<b>Reference code acc. to DIN EN 81346-2</b>	S
<b>Reference code acc. to DIN EN 61346-2</b>	S
<b>Continuous current of the C characteristic MCB</b>	10 A; for a short-circuit current smaller than 400 A
<b>Continuous current of the quick DIAZED fuse link</b>	10 A
<b>Continuous current of the DIAZED fuse link gG</b>	10 A
<b>Operating voltage</b>	

- at AC
  - at 50 Hz rated value 5 ... 500 V
  - at 60 Hz rated value 5 ... 500 V
- at DC
  - rated value 5 ... 500 V

### Power Electronics

<b>Contact reliability</b>	One maloperation per 100 million (17 V, 5 mA), one maloperation per 10 million (5 V, 1 mA)
----------------------------	--

### Supply voltage

<b>Type of voltage of the supply voltage</b>	AC
<ul style="list-style-type: none"> <li>• of the light source</li> </ul>	
<b>Supply voltage of the light source at AC</b>	
<ul style="list-style-type: none"> <li>• at 50 Hz rated value 110 V</li> <li>• at 60 Hz rated value 110 V</li> </ul>	

### Control circuit/ Control

<b>Inrush current of LED module maximum</b>	3 A
---	-----

### Auxiliary circuit

<b>Design of the contact of auxiliary contacts</b>	Silver alloy
<b>Number of NC contacts for auxiliary contacts</b>	1
<b>Number of NO contacts for auxiliary contacts</b>	0

### Connections/ Terminals

<b>Type of electrical connection</b>	Screw-type terminal
<ul style="list-style-type: none"> <li>• of modules and accessories</li> </ul>	
<b>Type of connectable conductor cross-sections</b>	
<ul style="list-style-type: none"> <li>• solid with core end processing 2x (0.5 ... 0.75 mm<sup>2</sup>)</li> <li>• solid without core end processing 2x (1.0 ... 1.5 mm<sup>2</sup>)</li> <li>• finely stranded with core end processing 2x (0.5 ... 1.5 mm<sup>2</sup>)</li> <li>• finely stranded without core end processing 2x (1,0 ... 1,5 mm<sup>2</sup>)</li> <li>• at AWG conductors 2x (18 ... 14)</li> </ul>	
<b>Tightening torque of the screws in the bracket</b>	1 ... 1.2 N·m
<b>Tightening torque</b>	
<ul style="list-style-type: none"> <li>• with screw-type terminals 0.8 ... 0.9 N·m</li> </ul>	

### Lamp

<b>Type of light source</b>	LED
<b>Color of the light source</b>	red
<b>Light intensity</b>	450 ... 1 120 mcd

### Ambient conditions

<b>Ambient temperature</b>	
<ul style="list-style-type: none"> <li>• during operation -25 ... +70 °C</li> <li>• during storage -40 ... +80 °C</li> </ul>	

Environmental category during operation acc. to IEC 60721	3M6, 3S2, 3B2, 3K6 (with relative air humidity of 10 ... 95 %, no condensation in operation permitted for all devices behind front panel)
---	---



### Installation/ mounting/ dimensions

<b>Mounting type</b>	front panel mounting
• of modules and accessories	Front plate mounting
<b>Height</b>	40 mm
<b>Width</b>	30 mm
<b>Shape of the installation opening</b>	round
<b>Mounting diameter</b>	22.3 mm
<b>Positive tolerance of installation diameter</b>	0.4 mm
<b>Mounting height</b>	11 mm
<b>Installation width</b>	29.5 mm
<b>Installation depth</b>	49.7 mm

### Certificates/ approvals

General Product Approval				Declaration of Conformity	
					<a href="#">Miscellaneous</a>
CCC	CSA	UL		EG-Konf.	

Test Certificates		Marine / Shipping			
<a href="#">Type Test Certificates/Test Report</a>	<a href="#">Special Test Certificate</a>				
		ABS	LRS	PRS	RINA

Marine / Shipping		other
		<a href="#">Confirmation</a>
RMRS	DNV-GL DNVGL.COM/AF	

### Further information

- Information- and Downloadcenter (Catalogs, Brochures,...)**  
<https://www.siemens.com/ic10>
- Industry Mall (Online ordering system)**  
<https://mall.industry.siemens.com/mall/en/en/Catalog/product?mfb=3SU1153-0AB20-1CA0>
- Cax online generator**  
<http://support.automation.siemens.com/WW/CAXorder/default.aspx?lang=en&mfb=3SU1153-0AB20-1CA0>
- Service&Support (Manuals, Certificates, Characteristics, FAQs,...)**  
<https://support.industry.siemens.com/cs/ww/en/ps/3SU1153-0AB20-1CA0>
- Image database (product images, 2D dimension drawings, 3D models, device circuit diagrams, EPLAN macros, ...)**  
[http://www.automation.siemens.com/bilddb/cax\\_de.aspx?mfb=3SU1153-0AB20-1CA0&lang=en](http://www.automation.siemens.com/bilddb/cax_de.aspx?mfb=3SU1153-0AB20-1CA0&lang=en)

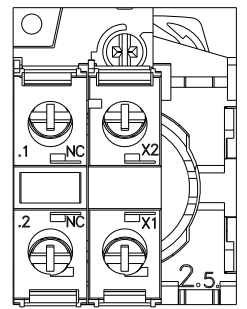
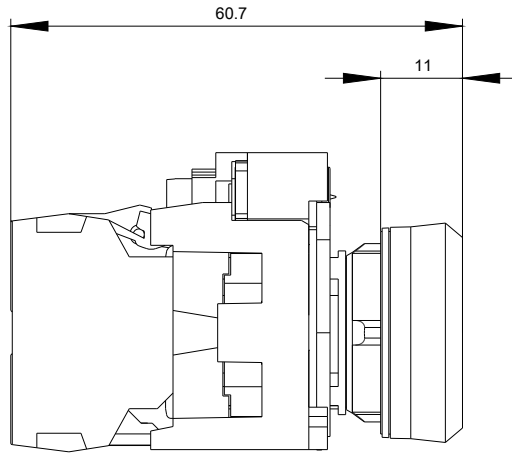
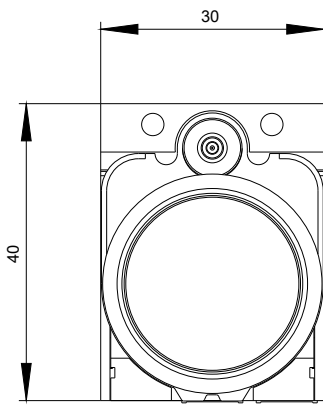

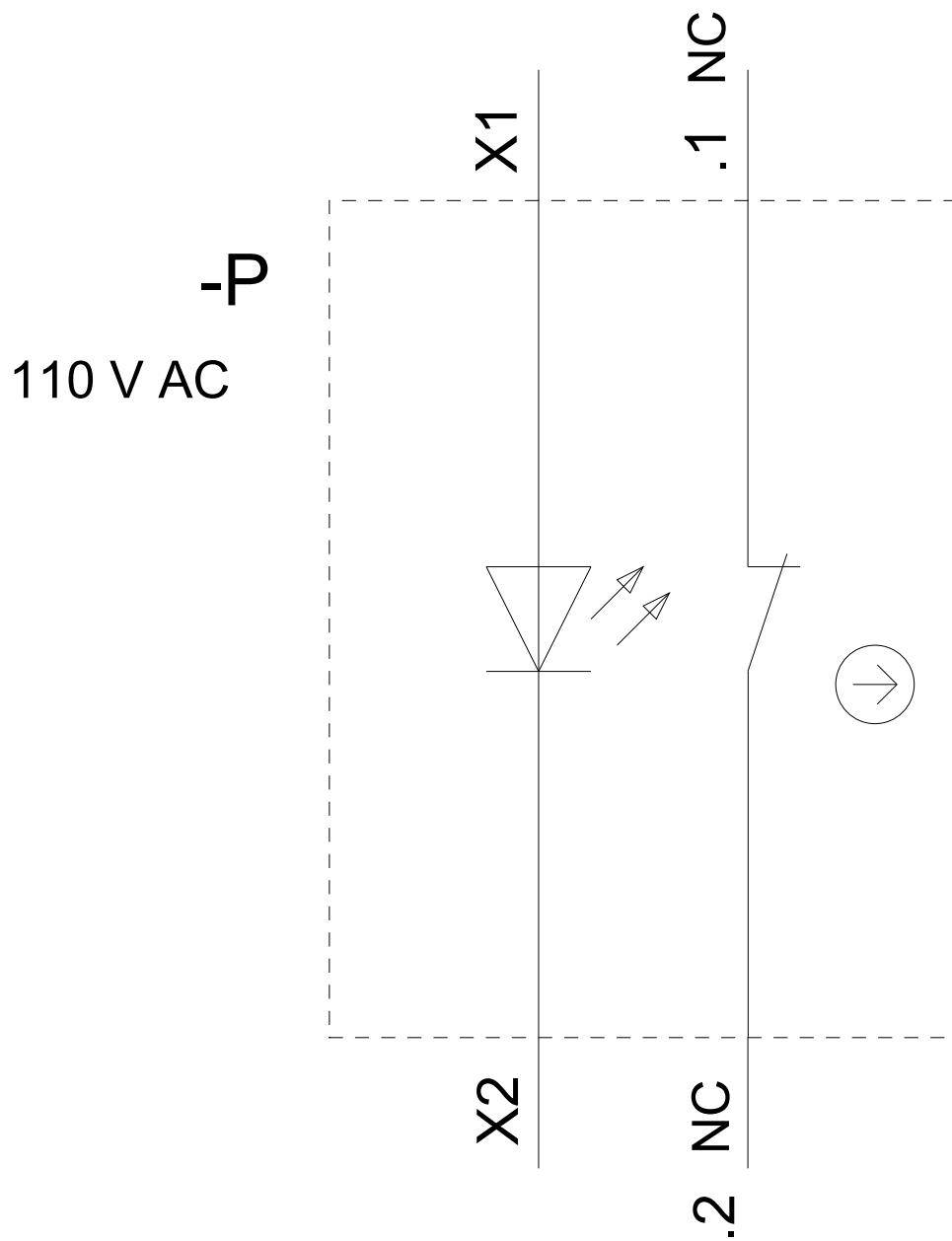

last modified:

03/10/2020