

Mushroom pushbutton, 22 mm, round, metal, shiny, red, 40 mm, latching, pull-to-unlatch mechanism, with holder, 1 NO+1 NC, Spring-type terminal

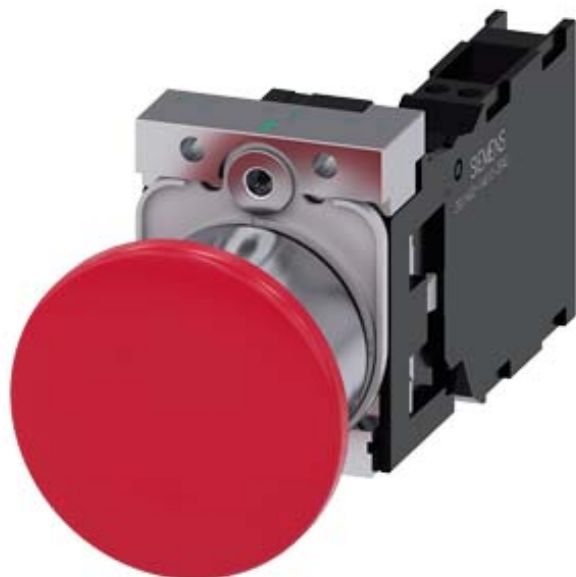

Product brand name	SIRIUS ACT
Product designation	Mushroom pushbuttons
Design of the product	Complete unit
Product type designation	3SU1
Product line	Metal, shiny, 22 mm
Manufacturer's article number	
<ul style="list-style-type: none"> • 1 of supplied contact module • of the supplied holder • of the supplied actuator 	3SU1400-1AA10-3FA0 3SU1550-0AA10-0AA0 3SU1050-1BA20-0AA0

Enclosure

Number of command points	1
---------------------------------	---

Actuator

Manner of function of the actuating element	latching
Product extension optional Light source	No
Color	
<ul style="list-style-type: none"> • of the actuating element 	red
Material of the actuating element	plastic
Shape of the actuating element	round

Outer diameter of the actuating element	40 mm
Number of contact modules	1
Type of unlocking device	pull-to-unlatch mechanism
Number of switching positions	2

Front ring

Product component front ring	Yes
Design of the front ring	Standard
Material of the front ring	Metal, high gloss
Color of the front ring	silver

Holder

Material of the holder	Metal
------------------------	-------

Display

Number of LEDs	0
----------------	---

General technical data

Product function	
• positive opening	Yes
• EMERGENCY OFF function	No
• EMERGENCY STOP function	No
Product component	
• Light source	No
Insulation voltage	
• rated value	500 V
Degree of pollution	3
Type of voltage	
• of the operating voltage	AC/DC
Surge voltage resistance rated value	6 kV
Protection class IP	IP66, IP67, IP69(IP69K)
• of the terminal	IP20
Degree of protection NEMA rating	1, 2, 3, 3R, 4, 4X, 12, 13
Shock resistance	
• acc. to IEC 60068-2-27	Sinusoidal half-wave 50 g / 11 ms
Vibration resistance	
• acc. to IEC 60068-2-6	10 ... 500 Hz: 5g
Operating frequency maximum	1 800 1/h
Mechanical service life (switching cycles)	
• typical	500 000
Electrical endurance (switching cycles)	
• typical	10 000 000
Thermal current	10 A
Reference code acc. to DIN EN 81346-2	P
Reference code acc. to DIN EN 61346-2	P

Continuous current of the C characteristic MCB	10 A; for a short-circuit current smaller than 400 A
Continuous current of the quick DIAZED fuse link	10 A
Continuous current of the DIAZED fuse link gG	10 A
Operating voltage	
<ul style="list-style-type: none"> • at AC <ul style="list-style-type: none"> — at 50 Hz rated value — at 60 Hz rated value • at DC <ul style="list-style-type: none"> — rated value 	5 ... 500 V 5 ... 500 V 5 ... 500 V

Power Electronics

Contact reliability	One maloperation per 100 million (17 V, 5 mA), one maloperation per 10 million (5 V, 1 mA)
----------------------------	--

Auxiliary circuit

Design of the contact of auxiliary contacts	Silver alloy
Number of NC contacts for auxiliary contacts	1
Number of NO contacts for auxiliary contacts	1

Connections/ Terminals

Type of electrical connection	
<ul style="list-style-type: none"> • of modules and accessories 	Spring-type terminal
Type of connectable conductor cross-sections	
<ul style="list-style-type: none"> • solid without core end processing • finely stranded with core end processing • finely stranded without core end processing • at AWG conductors 	2x (0.25 ... 1.5 mm ²) 2x (0.25 ... 0.75 mm ²) 2x (0.25 ... 1.5 mm ²) 2x (24 ... 16)
Tightening torque of the screws in the bracket	1 ... 1.2 N·m

Ambient conditions

Ambient temperature	
<ul style="list-style-type: none"> • during operation • during storage 	-25 ... +70 °C -40 ... +80 °C
Environmental category during operation acc. to IEC 60721	3M6, 3S2, 3B2, 3C3, 3K6 (with relative air humidity of 10 ... 95 %, no condensation in operation permitted for all devices behind front panel)

Installation/ mounting/ dimensions



Mounting type	
<ul style="list-style-type: none"> • of modules and accessories 	Front plate mounting
Height	40 mm
Width	40 mm
Shape of the installation opening	round
Mounting diameter	22.3 mm
Positive tolerance of installation diameter	0.4 mm
Mounting height	27.5 mm

Installation width	40 mm
Installation depth	71.7 mm

Certificates/ approvals

General Product Approval				Declaration of Conformity	
					Miscellaneous
CCC	CSA	UL		EG-Konf.	

Test Certificates		Marine / Shipping			
Type Test Certificates/Test Report	Special Test Certificate				
		ABS	LRS	PRS	RINA

Marine / Shipping		other
		Confirmation
RMRS	DNV-GL DNVGL.COM/AF	

Further information

Information- and Downloadcenter (Catalogs, Brochures,...)

<https://www.siemens.com/ic10>

Industry Mall (Online ordering system)

<https://mall.industry.siemens.com/mall/en/en/Catalog/product?mlfb=3SU1150-1BA20-3FA0>

Cax online generator

<http://support.automation.siemens.com/WW/CAXorder/default.aspx?lang=en&mlfb=3SU1150-1BA20-3FA0>

Service&Support (Manuals, Certificates, Characteristics, FAQs,...)

<https://support.industry.siemens.com/cs/ww/en/ps/3SU1150-1BA20-3FA0>

Image database (product images, 2D dimension drawings, 3D models, device circuit diagrams, EPLAN macros, ...)

http://www.automation.siemens.com/bilddb/cax_de.aspx?mlfb=3SU1150-1BA20-3FA0&lang=en

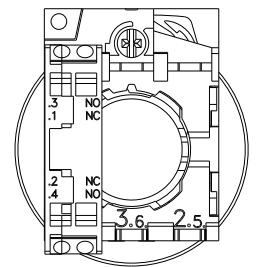
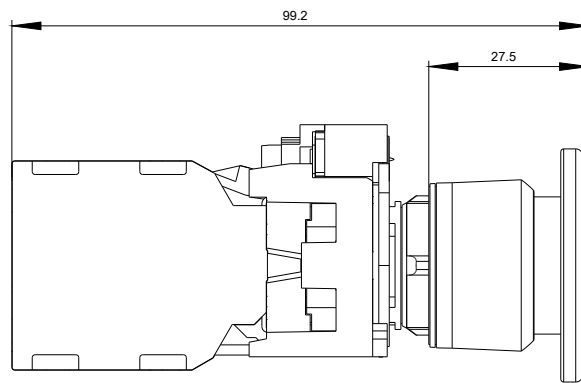
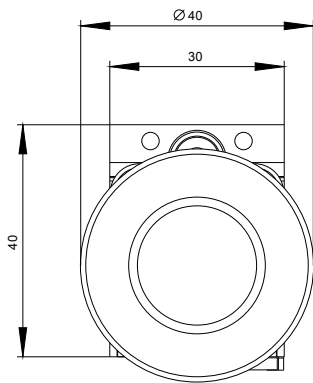

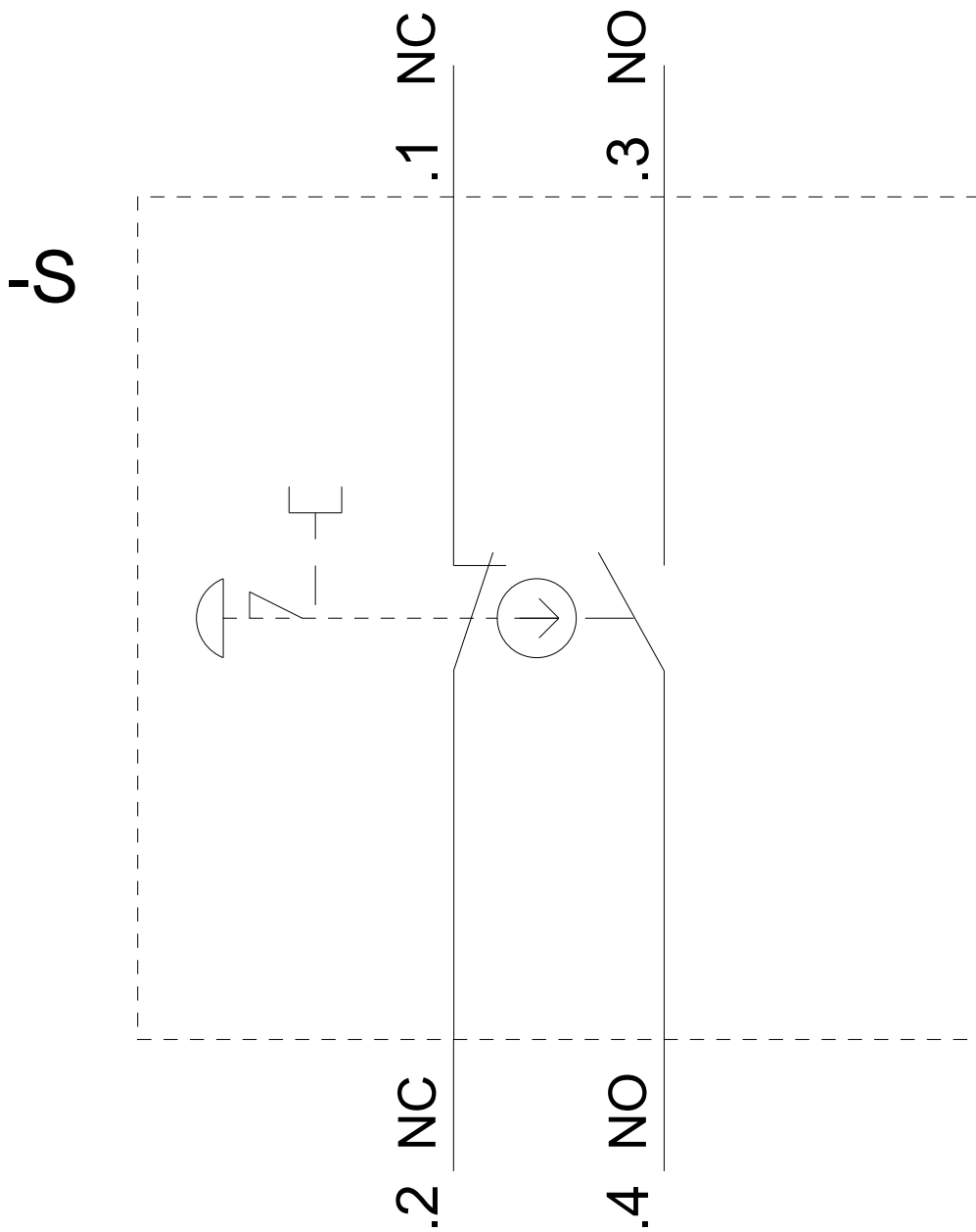

last modified:

03/06/2020