

Selector switch, illuminable, 22 mm, round, metal, shiny, white, selector switch, long, 2 switch positions O-I, latching, actuating angle 90°, 10:30h/13:30h



Product brand name	SIRIUS ACT
Product designation	Selector switches
Design of the product	Actuating/signaling element
Product type designation	3SU1
Product line	Metal, shiny, 22 mm

Enclosure	
Number of command points	1

Actuator	
Design of the operating mechanism	Selector, long
Manner of function of the actuating element	latching, 90° (10:30 h/13:30 h)
Product extension optional Light source	Yes
Color of the actuating element	white
Material of the actuating element	plastic
Shape of the actuating element	Handle
Outer diameter of the actuating element	44.8 mm
Number of switching positions	2
Actuating angle	90°
<ul style="list-style-type: none"> clockwise 	90°

Front ring	
Product component front ring	Yes
Design of the front ring	standard
Material of the front ring	Metal, high gloss
Color of the front ring	silver

General technical data	
Protection class IP	IP66, IP67, IP69(IP69K)
Degree of protection NEMA rating	1, 2, 3, 3R, 4, 4X, 12, 13
Shock resistance	
<ul style="list-style-type: none"> acc. to IEC 60068-2-27 	Sinusoidal half-wave 50 g / 11 ms
Vibration resistance	
<ul style="list-style-type: none"> acc. to IEC 60068-2-6 	10 ... 500 Hz: 5g
Operating frequency maximum	1 800 1/h
Mechanical service life (switching cycles)	
<ul style="list-style-type: none"> typical 	1 000 000
Reference code acc. to DIN EN 81346-2	S
Reference code acc. to DIN EN 61346-2	S

Safety related data	
B10 value	
<ul style="list-style-type: none"> with high demand rate acc. to SN 31920 	100 000
Proportion of dangerous failures	
<ul style="list-style-type: none"> with low demand rate acc. to SN 31920 	20 %
<ul style="list-style-type: none"> with high demand rate acc. to SN 31920 	20 %
Failure rate [FIT]	
<ul style="list-style-type: none"> with low demand rate acc. to SN 31920 	100 FIT
T1 value for proof test interval or service life acc. to IEC 61508	20 y





Ambient conditions	
Ambient temperature	
<ul style="list-style-type: none"> during operation 	-25 ... +70 °C
<ul style="list-style-type: none"> during storage 	-40 ... +80 °C
Environmental category during operation acc. to IEC 60721	3M6, 3S2, 3B2, 3C3, 3K6 (with relative air humidity of 10 ... 95 %)





Installation/ mounting/ dimensions	
Height	44.8 mm
Width	44.8 mm
Shape of the installation opening	round
Mounting diameter	22.3 mm
Positive tolerance of installation diameter	0.4 mm
Mounting height	28.8 mm
Installation width	44.8 mm

Installation depth

25.4 mm

Certificates/ approvals

General Product Approval	Declaration of Conformity	Test Certificates
 CSA	 UL	
 EG-Konf.	Miscellaneous	Type Test Certificates/Test Report

Test Certificates	Marine / Shipping
Special Test Certificate	 ABS
	 LRS
	 PRS
	 RINA
	 RMRS

Marine / Shipping	other
 DNV-GL DNVGL.COM/AF	Confirmation

Further information

Information- and Downloadcenter (Catalogs, Brochures,...)

<https://www.siemens.com/ic10>

Industry Mall (Online ordering system)

<https://mall.industry.siemens.com/mall/en/en/Catalog/product?mlfb=3SU1052-2CF60-0AA0>

Cax online generator

<http://support.automation.siemens.com/WW/CAXorder/default.aspx?lang=en&mlfb=3SU1052-2CF60-0AA0>

Service&Support (Manuals, Certificates, Characteristics, FAQs,...)

<https://support.industry.siemens.com/cs/ww/en/ps/3SU1052-2CF60-0AA0>

Image database (product images, 2D dimension drawings, 3D models, device circuit diagrams, EPLAN macros, ...)

http://www.automation.siemens.com/bilddb/cax_de.aspx?mlfb=3SU1052-2CF60-0AA0&lang=en

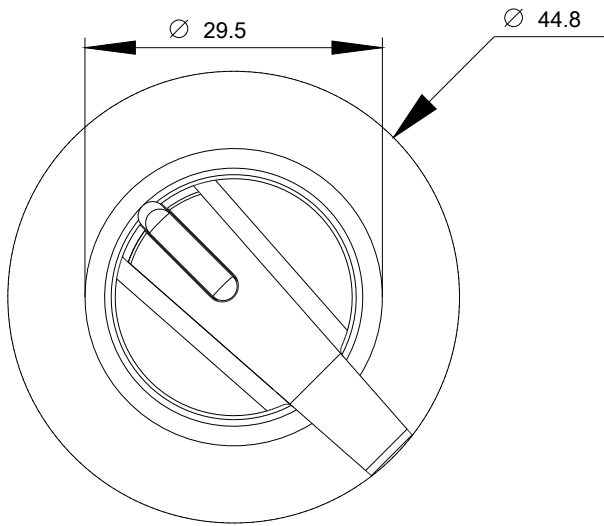

last modified:

03/06/2020