

Illuminable selector switch, 22 mm, round, metal shiny, black,  
Selector switch short, 2 switch positions O<I, momentary contact  
type, Actuating angle 45°, 10:30h/12h



Product brand name	SIRIUS ACT
Product designation	Selector switches
Design of the product	Actuating/signaling element
Product type designation	3SU1
Product line	Metal, shiny, 22 mm

#### Enclosure

Number of command points	1
--------------------------	---

#### Actuator

Design of the operating mechanism	Selector, short
Manner of function of the actuating element	momentary contact, 45° (10:30 h/12 h), return from center to left
Product extension optional Light source	Yes
Color of the actuating element	black
Material of the actuating element	plastic
Shape of the actuating element	Handle
Outer diameter of the actuating element	32.3 mm
Number of switching positions	2
Actuating angle	45°
<ul style="list-style-type: none"> <li>clockwise</li> </ul>	

Front ring	
Product component front ring	Yes
Design of the front ring	standard
Material of the front ring	Metal, high gloss
Color of the front ring	silver

General technical data	
Protection class IP	IP66, IP67, IP69(IP69K)
Degree of protection NEMA rating	1, 2, 3, 3R, 4, 4X, 12, 13
Shock resistance	
<ul style="list-style-type: none"> <li>acc. to IEC 60068-2-27</li> </ul>	Sinusoidal half-wave 50 g / 11 ms
Vibration resistance	
<ul style="list-style-type: none"> <li>acc. to IEC 60068-2-6</li> </ul>	10 ... 500 Hz: 5g
Operating frequency maximum	1 800 1/h
Mechanical service life (switching cycles)	
<ul style="list-style-type: none"> <li>typical</li> </ul>	1 000 000
Reference code acc. to DIN EN 81346-2	S
Reference code acc. to DIN EN 61346-2	S

Safety related data	
B10 value	
<ul style="list-style-type: none"> <li>with high demand rate acc. to SN 31920</li> </ul>	500 000
Proportion of dangerous failures	
<ul style="list-style-type: none"> <li>with low demand rate acc. to SN 31920</li> </ul>	20 %
<ul style="list-style-type: none"> <li>with high demand rate acc. to SN 31920</li> </ul>	20 %
Failure rate [FIT]	
<ul style="list-style-type: none"> <li>with low demand rate acc. to SN 31920</li> </ul>	100 FIT
T1 value for proof test interval or service life acc. to IEC 61508	20 y





Ambient conditions	
Ambient temperature	
<ul style="list-style-type: none"> <li>during operation</li> </ul>	-25 ... +70 °C
<ul style="list-style-type: none"> <li>during storage</li> </ul>	-40 ... +80 °C
Environmental category during operation acc. to IEC 60721	3M6, 3S2, 3B2, 3C3, 3K6 (with relative air humidity of 10 ... 95 %)





Installation/ mounting/ dimensions	
Height	32.3 mm
Width	32.3 mm
Shape of the installation opening	round
Mounting diameter	22.3 mm
Positive tolerance of installation diameter	0.4 mm
Mounting height	28.8 mm
Installation width	32.3 mm

Installation depth

25.4 mm

## Certificates/ approvals

General Product Approval	Declaration of Conformity	Test Certificates
 CSA	 UL	
 EG-Konf.	<a href="#">Miscellaneous</a>	<a href="#">Type Test Certificates/Test Report</a>

Test Certificates	Marine / Shipping
<a href="#">Special Test Certificate</a>	 ABS
	 LRS
	 PRS
	 RINA
	 RMRS

Marine / Shipping	other
 DNV-GL DNVGL.COM/AF	<a href="#">Confirmation</a>

## Further information

**Information- and Downloadcenter (Catalogs, Brochures,...)**

<https://www.siemens.com/ic10>

**Industry Mall (Online ordering system)**

<https://mall.industry.siemens.com/mall/en/en/Catalog/product?mlfb=3SU1052-2BC10-0AA0>

**Cax online generator**

<http://support.automation.siemens.com/WW/CAXorder/default.aspx?lang=en&mlfb=3SU1052-2BC10-0AA0>

**Service&Support (Manuals, Certificates, Characteristics, FAQs,...)**

<https://support.industry.siemens.com/cs/ww/en/ps/3SU1052-2BC10-0AA0>

**Image database (product images, 2D dimension drawings, 3D models, device circuit diagrams, EPLAN macros, ...)**

[http://www.automation.siemens.com/bilddb/cax\\_de.aspx?mlfb=3SU1052-2BC10-0AA0&lang=en](http://www.automation.siemens.com/bilddb/cax_de.aspx?mlfb=3SU1052-2BC10-0AA0&lang=en)

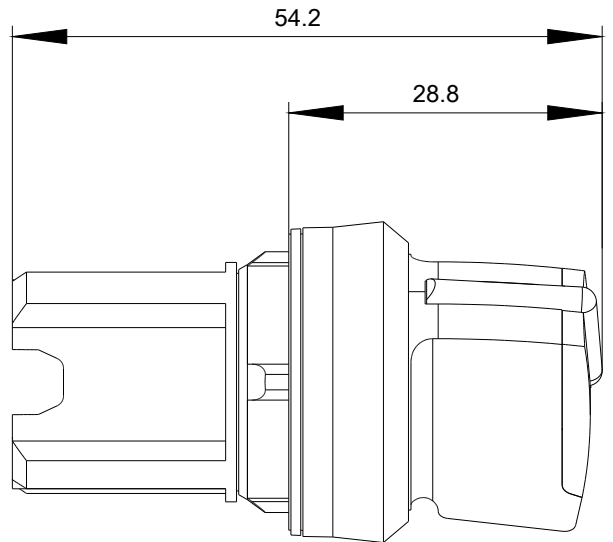

last modified:

03/06/2020