

SIRIUS safety relay Basic unit 3SK2 series 20 F-DI, 4 F-DQ, 2 DQ, 24 V DC Can be parameterized via SIRIUS Safety ES 45 mm overall width Spring-type terminal (push-in) up to SILCL 3 (DIN EN 62061) Up to Performance Level E (ISO 13849-1) Output expansions 3SK1 and fail-safe motor starters 3RM1 via device connector connectable



Product brand name	SIRIUS
Product category	Safety relay
Product designation	Base-Unit
Design of the product	20 F-DI, 4 F-DQ, 2 DQ

General technical data

Product function	
• EMERGENCY STOP function	Yes
• protective door monitoring	Yes
• protective door monitoring with tumbler	Yes
• muting, 2 sensor-parallel	Yes
• muting, 4 sensor-parallel	Yes
• muting, 4 sensor-sequential	Yes
• Monitoring parameterizable	Yes
• evaluation: electro-sensitive protective equipment	Yes
• evaluation: selector switch	Yes
• Pressure-sensitive mat monitoring	Yes
• evaluation: two-hand operator panel	Yes
• evaluation: enabling switch	Yes

<ul style="list-style-type: none"> • monitored start-up 	Yes
<ul style="list-style-type: none"> • two-hand control acc. to EN 574 	Yes
Configuration software required	Yes; Safety ES V1.0 and higher
Number of function blocks typical	50
Degree of pollution	3
Surge voltage resistance rated value	800 V
Protection class IP	IP20
<ul style="list-style-type: none"> • of the enclosure 	IP20
<ul style="list-style-type: none"> • of the terminal 	IP20
Shock resistance	15g / 11 ms
Operating frequency maximum	2 000 1/h
Reference code acc. to DIN EN 81346-2	F
Reference code acc. to DIN EN 61346-2	K
Period of darkness of the common drivers	3 ms
Product function suitable for AS-i Power24V	No
Product function Diagnostics with CTT2 slave	No
Protocol is supported ASIsafe (Safety at work) protocol	No
Suitability for use	
<ul style="list-style-type: none"> • Monitoring of floating sensors 	Yes
<ul style="list-style-type: none"> • Monitoring of non-floating sensors 	Yes
<ul style="list-style-type: none"> • position switch monitoring 	Yes
<ul style="list-style-type: none"> • EMERGENCY-OFF circuit monitoring 	Yes
<ul style="list-style-type: none"> • valve monitoring 	Yes
<ul style="list-style-type: none"> • opto-electronic protection device monitoring 	Yes
<ul style="list-style-type: none"> • magnetically operated switch monitoring 	Yes
<ul style="list-style-type: none"> • proximity switch monitoring 	Yes
<ul style="list-style-type: none"> • safety-related circuits 	Yes
Suitability for use for monitoring of optoelectronic protective devices acc. to IEC 61496-1	Yes
Operating power rated value	4.5 W
Communication/ Protocol	
Protocol optional is supported PROFIBUS DP protocol	Yes; when using the DP interface module; 64 bit cyclical data
Protocol is supported AS-Interface protocol	No
Amount of data of the cyclic user data	
<ul style="list-style-type: none"> • for inputs with PROFIBUS DP 	64 bit
<ul style="list-style-type: none"> • for outputs with PROFIBUS DP 	64 bit
Control circuit/ Control	
Type of voltage	DC
Type of voltage of the control supply voltage	DC
Control supply voltage rated value	24 V

Control supply voltage 1 at DC rated value	24 V
Inrush current peak	
• at 24 V	11 A
Duration of inrush current peak	
• at 24 V	1 ms
Consumed current for rated value of supply voltage without semiconductor output	185 mA

Inputs/ Outputs

Product function	
• Parameterizable inputs	Yes
• Parameterizable outputs	Yes
• at the digital outputs Short-circuit protection	Yes
Number of inputs	
• safety-related	20
• non-safety-related	0
Input delay time	0 ... 150 ms
Type of digital inputs acc. to IEC 60947-1	Type 1
Input recording time at digital input maximum	60 ms
Input delay time at digital input maximum	150 ms
Input voltage at digital input	
• at DC rated value	24 V
• with signal <0> at DC	-3 ... +5 V
• for signal <1> at DC	15 ... 30
Input current at digital input	
• for signal <1> typical	2.6 mA
Number of outputs	
• safety-related 2-channel	4
• for testing contact-based sensors	4
Number of outputs as contact-affected switching element safety-related	
• 1-channel	0
• 2-channel	0
Number of outputs as contact-less semiconductor switching element non-safety-related	2
Design of the contactless switching element safety-related	P potential
Recovery time of the safe outputs	0 ms
Readback time maximum	400 ms
Light test period	3 ms
Switching capacity current of semiconductor outputs at DC-13 at 24 V	4 A
Residual current	
• maximum	0.05 mA

<ul style="list-style-type: none"> • at digital output with signal <0> maximum 	0.1 mA
Total current maximum	7 A
Voltage drop maximum	0.5 V
Wire length of the signal cable	
<ul style="list-style-type: none"> • to the inputs <ul style="list-style-type: none"> — shielded maximum — unshielded maximum • to the outputs <ul style="list-style-type: none"> — shielded maximum — unshielded maximum 	1 000 m 600 m 1 000 m 600 m

Installation/ mounting/ dimensions

Mounting position	any
Mounting type	Snap-mounted to DIN rail or screw-mounted with additional push-in lug
Height	100 mm
Width	45 mm
Depth	124.5 mm

Connections/ Terminals

Product function removable terminal	Yes
Type of connectable conductor cross-sections	
<ul style="list-style-type: none"> • solid 	1x (0.5 ... 1.5 mm ²), 2x (0.5 ... 1.5 mm ²)
<ul style="list-style-type: none"> • finely stranded with core end processing 	1x (0.5 ... 1.0 mm ²), 2x (0.5 ... 1.0 mm ²)
<ul style="list-style-type: none"> • at AWG conductors solid 	1x (20 ... 16), 2x (20 ... 16)
<ul style="list-style-type: none"> • at AWG conductors stranded 	1x (20 ... 16), 2x (20 ... 16)
Connectable conductor cross-section finely stranded with core end processing	0.5 ... 1 mm ²
AWG number as coded connectable conductor cross section	
<ul style="list-style-type: none"> • solid 	20 ... 16
<ul style="list-style-type: none"> • stranded 	20 ... 16

Safety related data

Stop category acc. to DIN EN 60204-1	0 / 1
Diagnostics test interval by internal test function maximum	1 000 s
PFHD with high demand rate acc. to EN 62061	0.000000012 1/h
T1 value for proof test interval or service life acc. to IEC 61508	20 y
Protection against electrical shock	finger-safe





Electromagnetic compatibility

EMC emitted interference acc. to IEC 60947-1	class A
Conducted interference	
<ul style="list-style-type: none"> • due to burst acc. to IEC 61000-4-4 	2 kV (power ports) / 1 kV (signal ports)

Field-bound parasitic coupling acc. to IEC 61000-4-3	10 V/m
Electrostatic discharge acc. to IEC 61000-4-2	4 kV contact discharge / 8 kV air discharge

Ambient conditions	
Installation altitude at height above sea level maximum	2 000 m
Air pressure acc. to SN 31205	90 ... 106 kPa

Certificates/ approvals

General Product Approval	Functional Safety/Safety of Machinery	Declaration of Conformity
 CSA  UL  EAC	Type Examination Certificate	Miscellaneous  EG-Konf.

other

[Confirmation](#)

Further information

Information- and Downloadcenter (Catalogs, Brochures,...)

www.siemens.com/ic10

Industry Mall (Online ordering system)

<https://mall.industry.siemens.com/mall/en/en/Catalog/product?mlfb=3SK2122-2AA10>

Cax online generator

<http://support.automation.siemens.com/WW/CAXorder/default.aspx?lang=en&mlfb=3SK2122-2AA10>

Service&Support (Manuals, Certificates, Characteristics, FAQs,...)

<https://support.industry.siemens.com/cs/ww/en/ps/3SK2122-2AA10>

Image database (product images, 2D dimension drawings, 3D models, device circuit diagrams, EPLAN macros, ...)

http://www.automation.siemens.com/bilddb/cax_de.aspx?mlfb=3SK2122-2AA10&lang=en

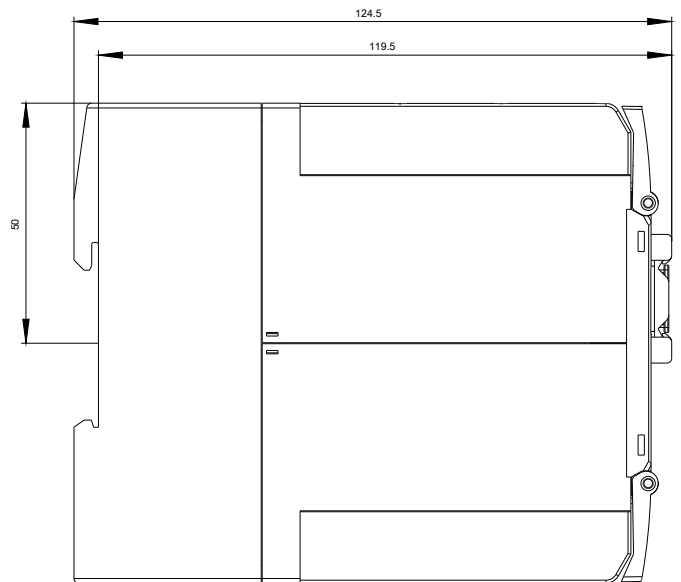
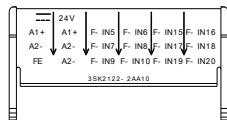
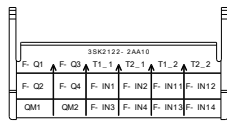
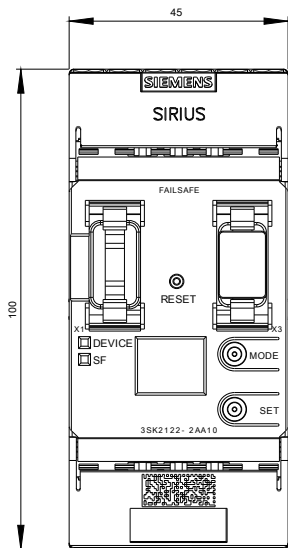

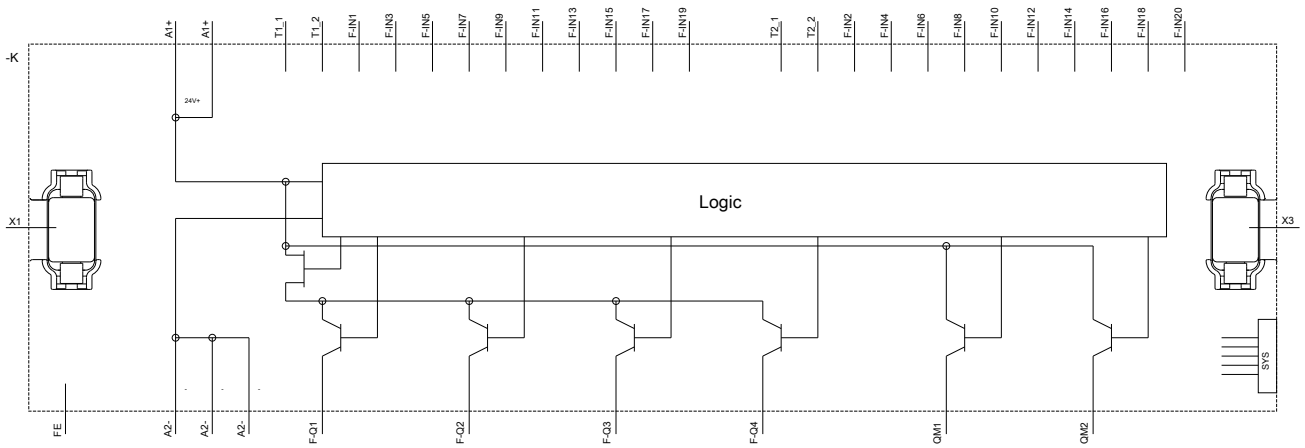

last modified:

12/20/2019