

Cable-operated switch and lever Metal enclosure, 2 x M25 x 1.5; 2 NO+2 NC, latching EN ISO 13850 and pushbutton release, 2-sided operation for wire lengths up to 2 x 100 m



Product brand name	SIRIUS
Product designation	cable-operated switch
Product type designation	3SE7

General technical data

Product function	
• EMERGENCY STOP function	Yes
Product component Light source	No
Insulation voltage	
• rated value	400 V
Degree of pollution	class 3
Surge voltage resistance rated value	6 kV
Protection class IP	IP65
Mechanical service life (switching cycles)	
• typical	100 000
Thermal current	6 A
Reference code acc. to DIN EN 81346-2	S
Reference code acc. to DIN EN 61346-2	S
Continuous current of the DIAZED fuse link gG	6 A
Number of NC contacts for auxiliary contacts	2

Number of NO contacts for auxiliary contacts	2
Operating current at AC-15	
• at 240 V rated value	6 A
• at 400 V rated value	6 A
Operating current at DC-13	
• at 24 V rated value	3 A
• at 250 V rated value	0.27 A

Enclosure

Material of the enclosure	metal
Material of the enclosure cover	Metal
Product component	
• EMERGENCY STOP device	No
Color	
• of the enclosure	black
• of top part of the enclosure	grey
Coating of the enclosure	painted
Circuit principle	Jump function
Material of the contact	Silver
Number of switching contacts safety-related	2

Connections/ Terminals

Type of electrical connection	screw-type terminals
Type of connectable conductor cross-sections	
• solid	2x (0.5 ... 2.5 mm ²)
• finely stranded with core end processing	2x (0.5 ... 2.5 mm ²)
• at AWG conductors solid	2x (20 ... 14)
• at AWG conductors stranded	2x (20 ... 14)

Safety related data

B10 value	
• with high demand rate acc. to SN 31920	100 000
Proportion of dangerous failures	
• with high demand rate acc. to SN 31920	50 %
Cable entry type	2x M25 x 1,5

Ambient conditions

Ambient temperature	
• during operation	-25 ... +70 °C

Display

Product function status display	No
--	----



Installation/ mounting/ dimensions

Mounting type	screw fixing
Height	160 mm

Width	127 mm
Depth	77 mm

Certificates/ approvals

General Product Approval			Declaration of Conformity	Marine / Shipping	
 CCC	 CSA	 UL	 EAC	 EG-Konf.	 ABS

Marine / Shipping	other
 LRS  PRS  DNV-GL DNVGL.COM/AF	Confirmation

Further information

Information- and Downloadcenter (Catalogs, Brochures,...)

<https://www.siemens.com/ic10>

Industry Mall (Online ordering system)

<https://mall.industry.siemens.com/mall/en/en/Catalog/product?mlfb=3SE7160-1AE00>

Cax online generator

<http://support.automation.siemens.com/WW/CAXorder/default.aspx?lang=en&mlfb=3SE7160-1AE00>

Service&Support (Manuals, Certificates, Characteristics, FAQs,...)





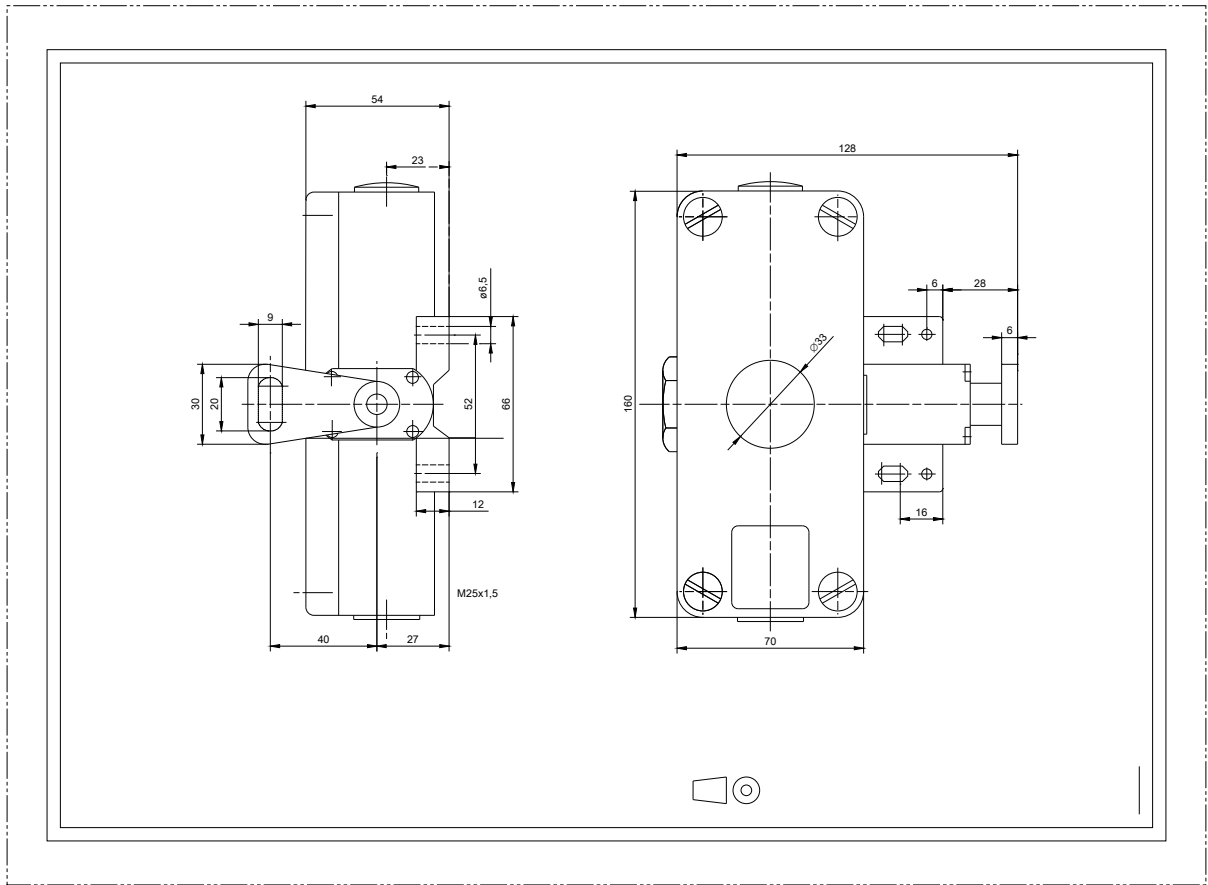

<https://support.industry.siemens.com/cs/ww/en/ps/3SE7160-1AE00>

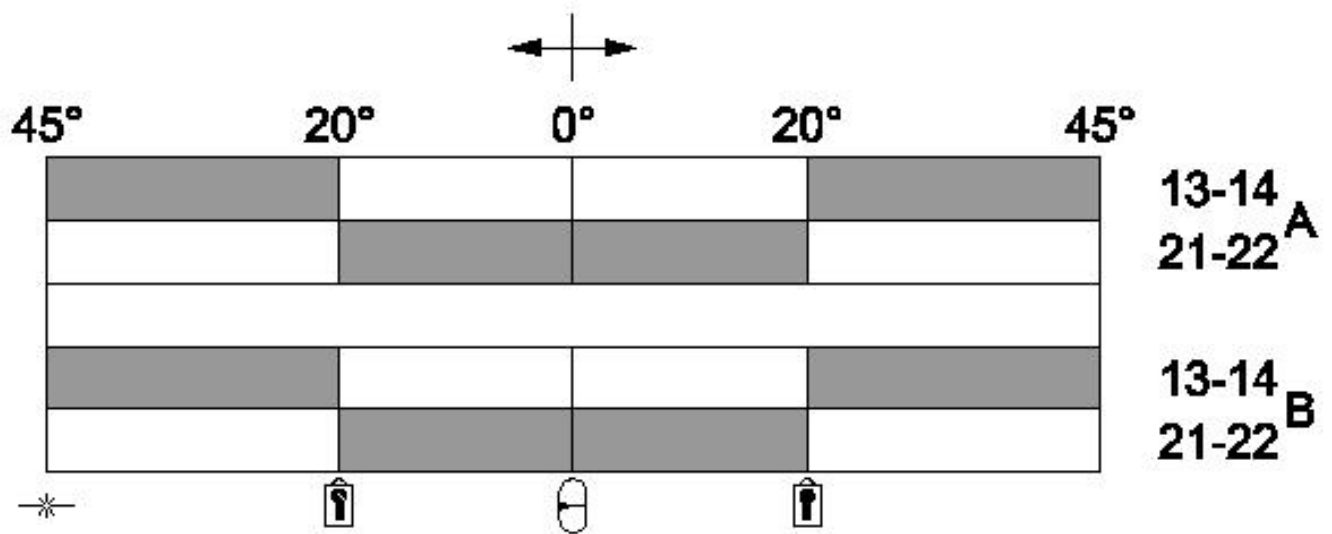
Image database (product images, 2D dimension drawings, 3D models, device circuit diagrams, EPLAN macros, ...)

http://www.automation.siemens.com/bilddb/cax_de.aspx?mlfb=3SE7160-1AE00&lang=en





-  **Verriegelung / Locking**
-  **Betätigungsrichtung / Travel**
-  **Mittelstellung / Middle position**
-  **Selbstriß / Rope rip**
-  **Schaltglied geschlossen / Contact element closed**
-  **Schaltglied geöffnet / Contact element open**

last modified:

02/22/2020