

Cable-operated switch Metal enclosure, 2 xM20 x1,5; 1 NO+1 NC, Latching, ISO 13850 and pushbutton release, for wire lengths up to 25 m



Product brand name	SIRIUS
Product designation	cable-operated switch
Product type designation	3SE7

General technical data

Product function	
• EMERGENCY STOP function	Yes
Product component Light source	No
Insulation voltage	
• rated value	400 V
Degree of pollution	class 3
Surge voltage resistance rated value	6 kV
Protection class IP	IP65
Mechanical service life (switching cycles)	
• typical	100 000
Thermal current	6 A
Reference code acc. to DIN EN 81346-2	S
Reference code acc. to DIN EN 61346-2	S
Continuous current of the DIAZED fuse link gG	6 A
Number of NC contacts for auxiliary contacts	1

Number of NO contacts for auxiliary contacts	1
Operating current at AC-15	
• at 240 V rated value	6 A
• at 400 V rated value	6 A
Operating current at DC-13	
• at 24 V rated value	3 A
• at 250 V rated value	0.27 A

Enclosure

Material of the enclosure	metal
Material of the enclosure cover	Plastic
Product component	
• EMERGENCY STOP device	No
Color	
• of the enclosure	black
• of top part of the enclosure	grey
Coating of the enclosure	painted
Circuit principle	Jump function
Material of the contact	Silver
Number of switching contacts safety-related	1

Connections/ Terminals

Type of electrical connection	screw-type terminals
Type of connectable conductor cross-sections	
• solid	2x (0.5 ... 2.5 mm ²)
• finely stranded with core end processing	2x (0.5 ... 2.5 mm ²)
• at AWG conductors solid	2x (20 ... 14)
• at AWG conductors stranded	2x (20 ... 14)

Safety related data

B10 value	
• with high demand rate acc. to SN 31920	100 000
Proportion of dangerous failures	
• with high demand rate acc. to SN 31920	50 %
Cable entry type	2x M20 x 1,5

Ambient conditions

Ambient temperature	
• during operation	-25 ... +70 °C

Display

Product function status display	Yes
--	-----





Installation/ mounting/ dimensions

Mounting type	screw fixing
Height	171 mm

Width	52 mm
Depth	54 mm

Certificates/ approvals

General Product Approval				Declaration of Conformity	
					Miscellaneous
CCC	CSA	UL		EG-Konf.	

Marine / Shipping				other	
				Confirmation	
ABS	LRS	PRS			

Further information

Information- and Downloadcenter (Catalogs, Brochures,...)

<https://www.siemens.com/ic10>

Industry Mall (Online ordering system)

<https://mall.industry.siemens.com/mall/en/en/Catalog/product?mfb=3SE7150-1BD00>

Cax online generator

<http://support.automation.siemens.com/WW/CAXorder/default.aspx?lang=en&mfb=3SE7150-1BD00>

Service&Support (Manuals, Certificates, Characteristics, FAQs,...)

<https://support.industry.siemens.com/cs/ww/en/ps/3SE7150-1BD00>

Image database (product images, 2D dimension drawings, 3D models, device circuit diagrams, EPLAN macros, ...)

http://www.automation.siemens.com/bilddb/cax_de.aspx?mfb=3SE7150-1BD00&lang=en

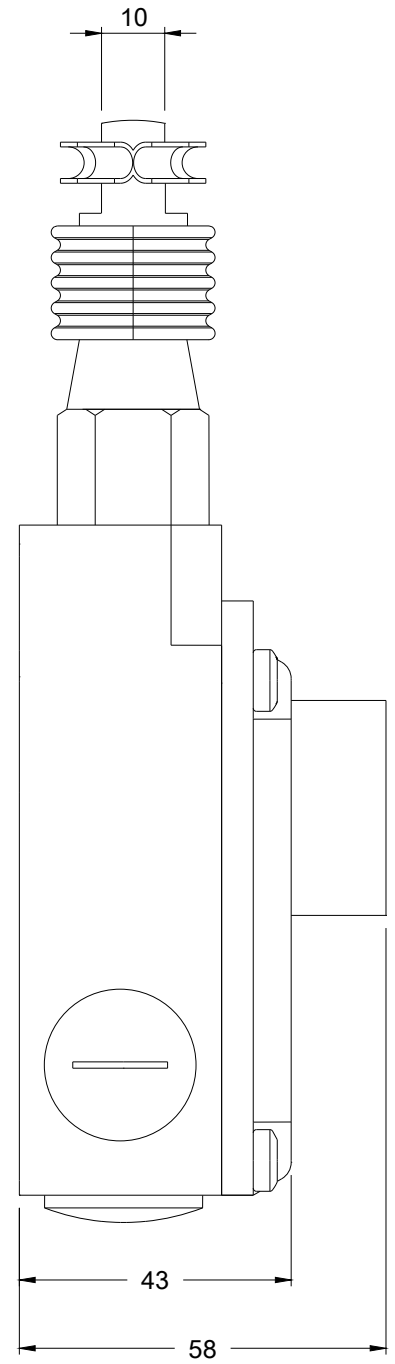
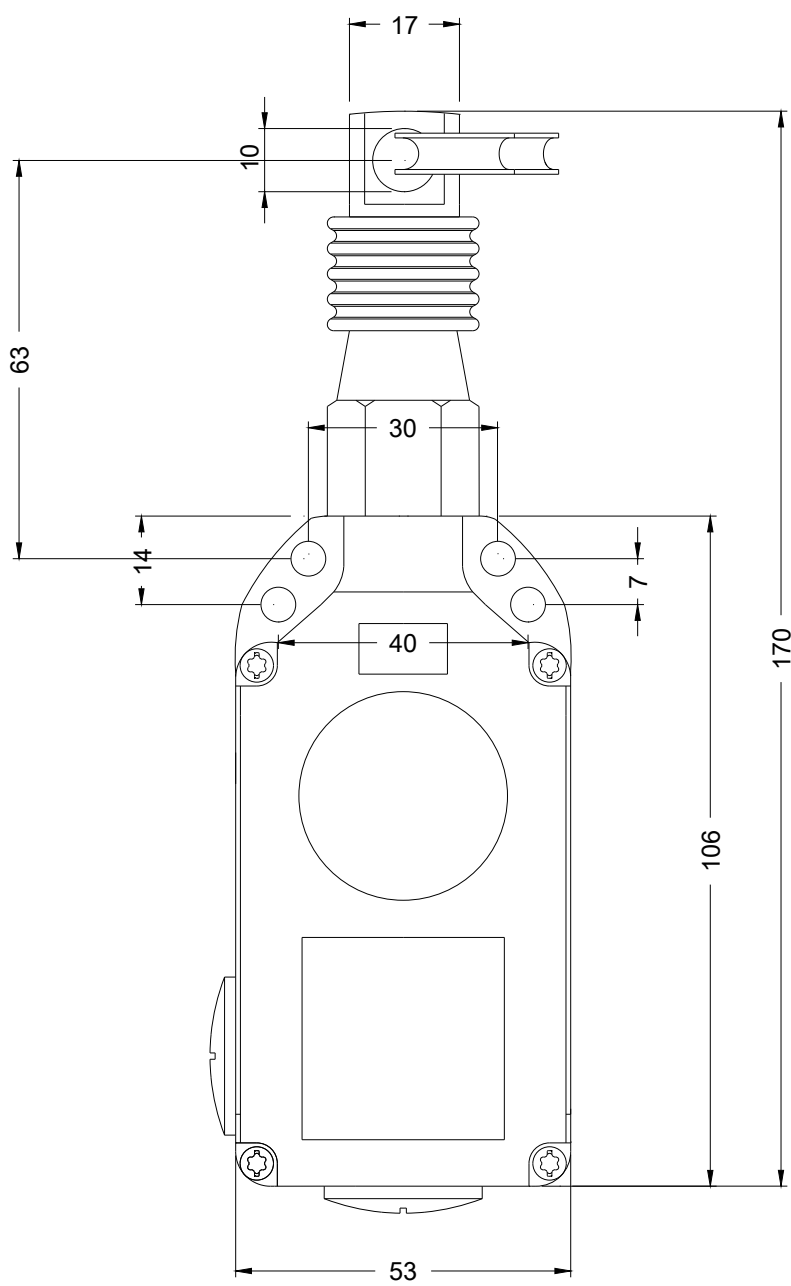

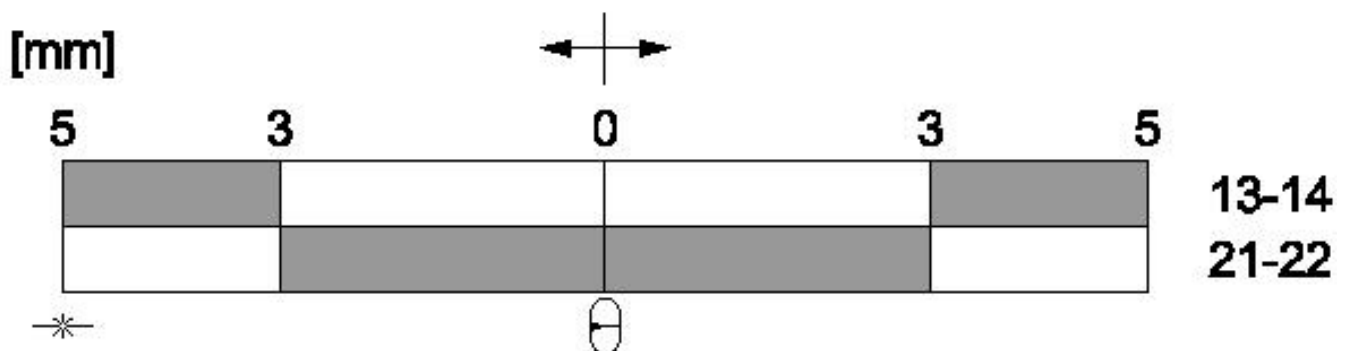

→ **Betätigungsrichtung / Travel**

⊕ **Mittelstellung / Middle position**

* — **Selbriß / Rope rip**

■ **Schaltglied geschlossen / Contact element closed**

□ **Schaltglied geöffnet / Contact element open**

last modified:

02/22/2020