

PROTEKTOR





The PROTEKTOR brand of profiles for plaster, render and drywall has been established for over 100 years and used by the general construction trade internationally.

Our profiles manufactured in galvanised steel, stainless steel, aluminium and PVCu are available for a variety of applications and probably represent the most comprehensive range of profiles available in the UK for the finishing industry.

A professional sales and technical team combined with good distribution enables us to assist in the design and supply of project requirements for standard and specialist profiles.



ISO 9001 quality control systems ensure that our range of products continue to conform to specification and our customers expectation.

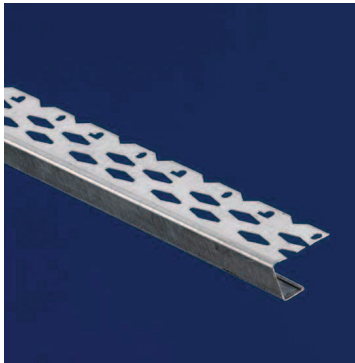

PROFILES FOR PLASTER, RENDER AND DRY WALL

Bead and Profiles for Dry Wall and a Thin Coat Finish	Page
Thin Coat and Dry Wall Corner Bead	4
Edge Bead and Thin Coat Stop Bead	5
Feature Bead.....	6
PVCu Dry Wall Corner and Arch Bead.....	7
PVCu Dry Wall Feature Bead	8
 Dry Wall Profiles for Partitions, Ceilings and Wall Linings	
Resilient Bar Profiles	9
Dry Wall Partition Profiles	10
Dry Wall Lining Profiles	12
MF Suspended Ceilings	14
 Bead for Plaster and Render Finishing	
Angle Bead	16
Stop Bead.....	17
Architrave Bead	18
Bell Cast Bead	19
Movement Bead.....	20
Internal Corner Movement Bead.....	21
Render Bead	22
 Expanded Metal	
Brick Reinforcement Coil	23
Expanded Metal Lath.....	24
Riblath	25
Security Mesh	26
Product Information	27

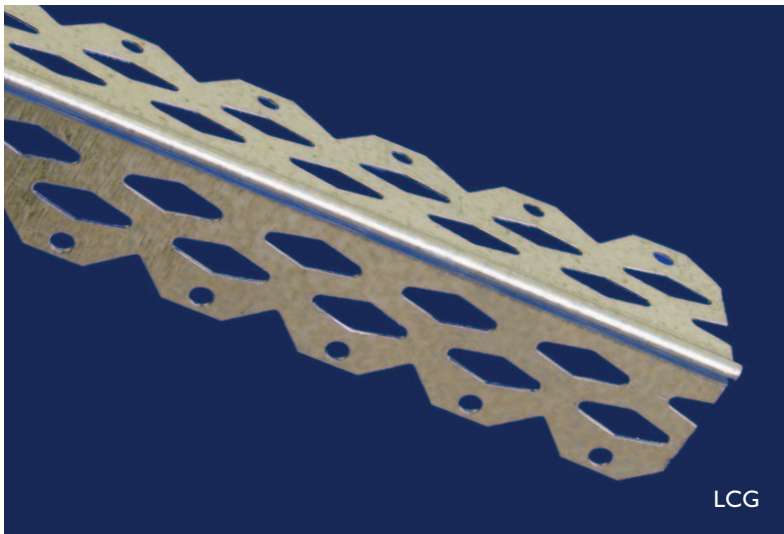

The Protektor range of beads provide protection to the edges of the finish, reducing the possibility of damage to the plasterboard.

Where corners require an obtuse angle of 135 degrees, profile LCG135 can be used. The profile is preset at this angle and designed to speed up installation and protect corners usually exposed to high traffic areas.

The Mini Mesh range of beads are designed for use when plastering slab, block work or rough surfaces, which need a thin coat finish.

TCG 22mm Dry Wall Bead

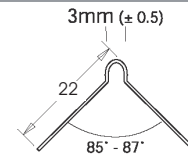

LCG 25mm Long Wing Thin Coat Bead

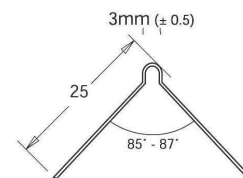

LCG(30) 30mm Thin Coat Bead

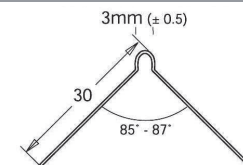

LCG135 25mm Wing 135° Angle Thin Coat Bead

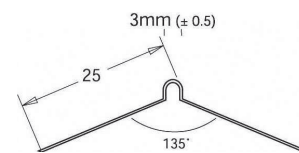

MMG 28mm Mini Mesh Bead

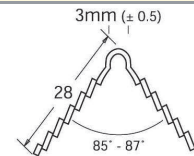

LMG 32mm Mini Mesh Bead

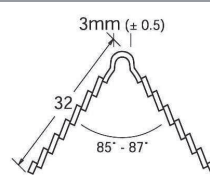

GALVANISED STEEL

Ref	Description	Length (mtr)			Quantity/box
		2.4	2.7	3.0	
TCG	22mm Thin Coat Bead	•	•	•	50
LCG	25mm Thin Coat Bead	•	•	•	50
LCG135	135° Thin Coat Bead	•		•	10
LCG(30)	30mm Thin Coat Bead			•	25
MMG	28mm Mini Mesh Bead	•	•	•	50
LMG	32mm Mini Mesh Bead			•	25

STAINLESS STEEL

Ref	Description	Length (mtr)	Quantity/box
		2.5	
2274	25mm Thin Coat Bead	•	25

EDGE BEAD AND THIN COAT STOP BEAD

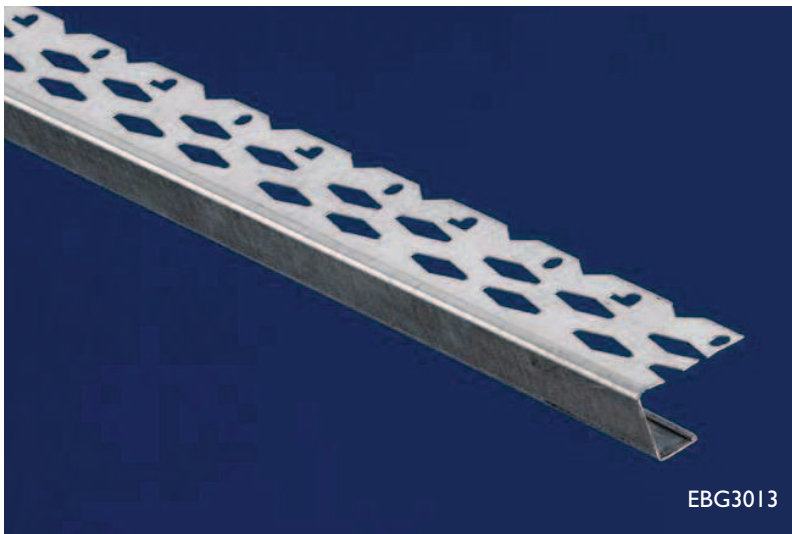

The Protektor range of Stop and Edge Beads are designed to reinforce the edges of plasterboard.

The edges of the perforated face must be fixed flush to the face of the board prior to finishing.

The edge bead profile is fixed to the board whilst in the process of installation, and provides edge protection at ceiling heads or window reveals.

SBG3 3mm Stop Bead



SBG6 6mm Stop Bead

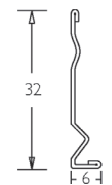

1234 10mm Stop Bead

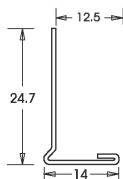

EBG3010 / EBS3010 9.5mm Edging Bead

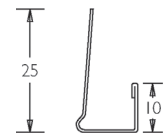

EBG3013 / EBS3013 12.5mm Edging Bead

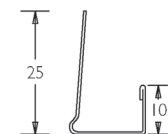

EBG3015 / EBS3015 15mm Edging Bead

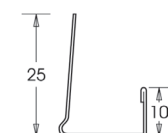

GALVANISED STEEL

Ref	Description	Length (mtr)			Quantity/box
		2.4	2.7	3.0	
SBG3	3mm Stop Bead	•	•	•	50
SBG6	6mm Stop Bead	•		•	50
1234	10mm Stop Bead			•	25
EBG3010	9.5mm Edging Bead			•	50
EBG3013	12.5mm Edging Bead			•	50
EBG3015	15mm Edging Bead			•	50

STAINLESS STEEL

Ref	Description	Length (mtr)		Quantity/box
		2.5	3.0	
2136	3mm Stop Bead	•		25
2135	6mm Stop Bead	•		25
EBS3010	9.5mm Edging Bead		•	25
EBS3013	12.5mm Edging Bead		•	25
EBS3015	15mm Edging Bead		•	25

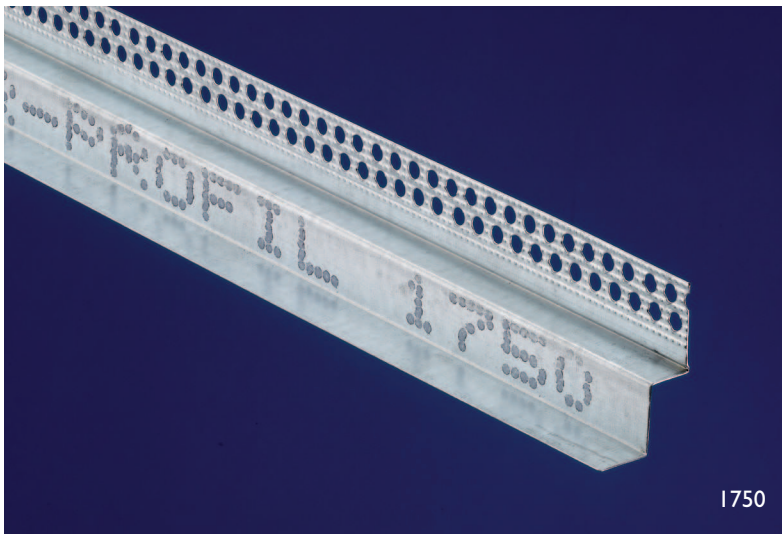

The Protektor range of Feature Beads are designed to act as a finishing profile whilst creating a shadow-like recess around door frames, ceilings and varying wall finishes.

The profiles provide protection to edges of the plasterboard whilst providing a straight edge for ruling off, hence speeding up the installation process dramatically.

1750 Double Step Feature Bead

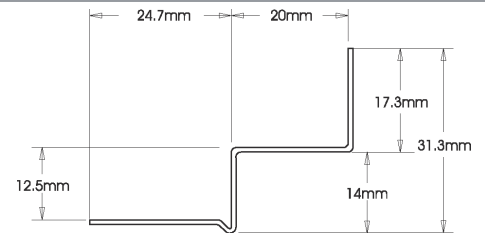

1751 Feature Bead with 20mm Gap

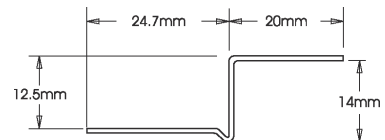

1311 Feature Bead with 15mm Return

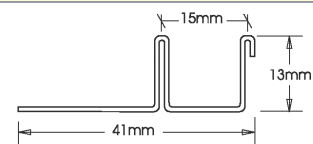

1314 Feature Bead with 10mm Gap

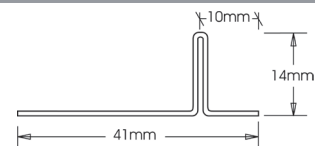

1371 Feature Bead with 4mm Gap

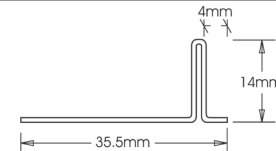

1304 Feature Bead with 10mm Gap

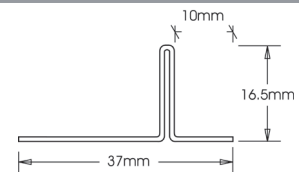

1377 Feature Bead with 5mm Gap

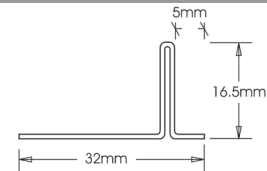

GALVANISED STEEL

Ref	Plasterboard Thickness (mm)	Description	Length (mtr)	Quantity/box
1750	12.5	Double Step Feature Bead	3.0	25
1751	12.5	Feature Bead with 20mm gap	3.0	25
1311	12.5	Feature Bead with 15mm return	3.0	15
1314	12.5	Feature Bead with 10mm gap	3.0	15
1371	12.5	Feature Bead with 5mm gap	3.0	15
1304	15	Feature Bead with 10mm gap	3.0	15
1377	15	Feature Bead with 5mm gap	3.0	15

PVCu DRY WALL CORNER AND ARCH BEAD

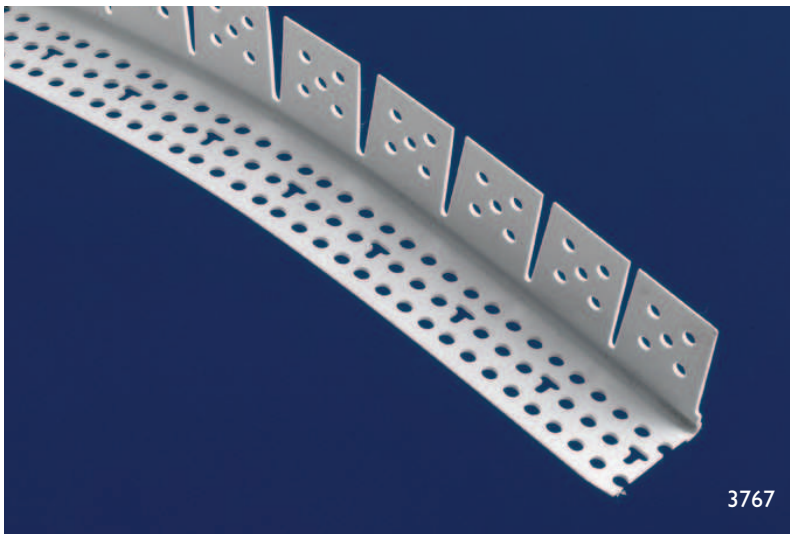

The Protektor PVCu range of beads for dry wall use and thin coat finishes all provide a straight line for the installer to work to.

The collection of profiles represent a small selection of the total range, but represent the more popular range of solutions required when working within dry wall constructions.

The ability to provide flexible profiles which can assist in creating curved lines and shadow like features within the finishing process drastically reduces on site installation times and hence associated costs.

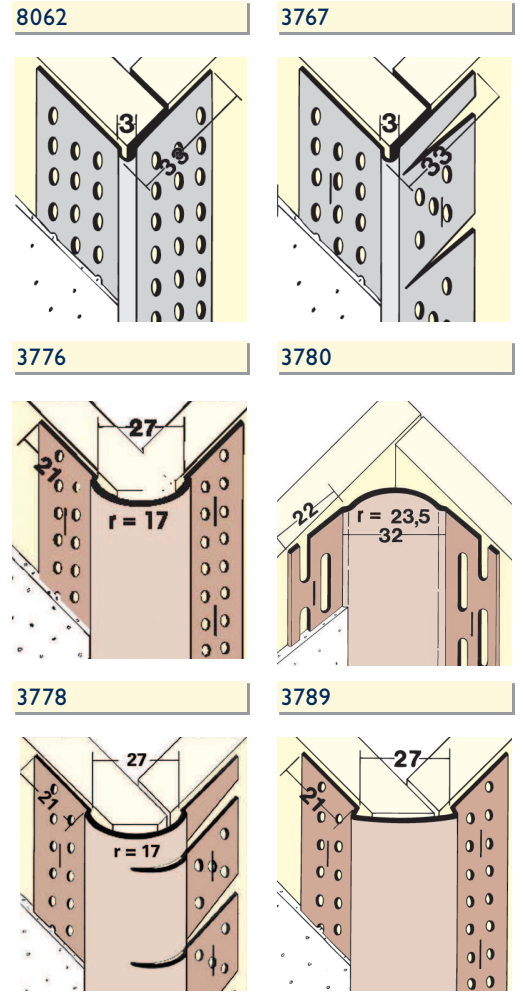

PVCu PROFILE

Ref	Description	Length (mtr) 3.0	Quantity/box
8062	32mm Wing Dry Wall Corner Bead	•	50
3767	32mm Wing Arch Bead	•	50
3776	Bull Nose Dry Wall Corner Bead	•	35
3778	Bull Nose Arch Dry Wall Corner Bead	•	35
3780	Round Internal Corner Dry Wall Profile	•	35
3789	Chamfer Dry Wall Corner Profile	•	30

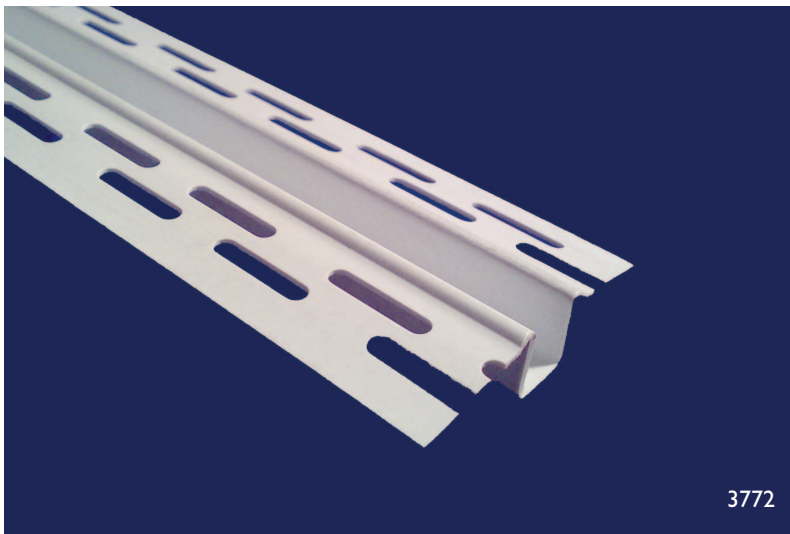

3772

The range of Protektor Feature Bead are used to create a reveal/shadow effect when butting up to door frames, skirting, ceilings, light boxes, and other interior constructions.

Perfect for creating fine line details the profile can be flexed to conform to curving walls, soffits and columns, the profiles are also used to finish rough drywall ends improving the final presentation of the partition where butting up to existing decor.

8045 8085

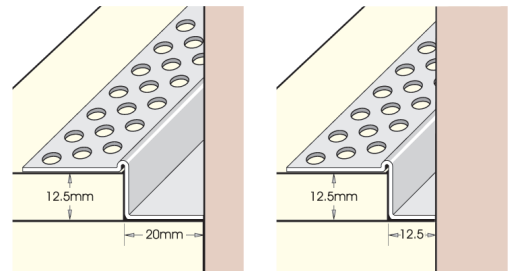

3772 3766

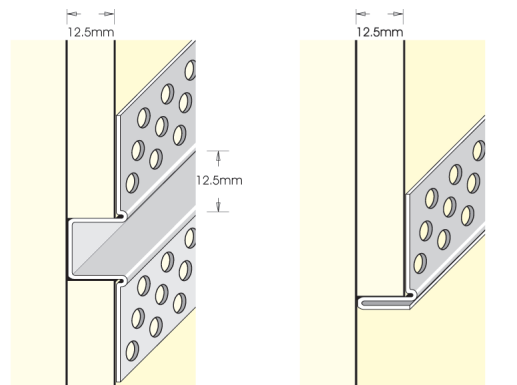

3768 3769

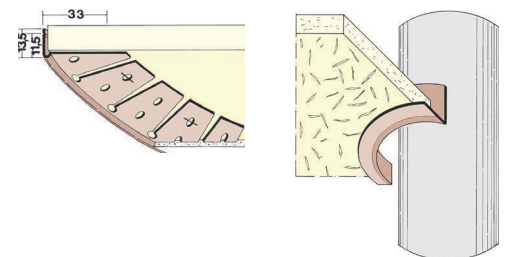

PVCu PROFILE

Ref	Description	Length (mtr)		Quantity/box
		2.5	3.0	
8045	Dry Wall Feature Bead - 20mm Gap		•	50
8085	Dry Wall Feature Bead - 12.5mm Gap		•	50
3772	Dry Wall Shadow Feature Bead		•	20
3766	Decor Edge Bead		•	35
3768	Dry Wall Flexible Edge Profile		•	20
3769	Dry Wall Flexible Corner Trim	•		10

RESILIENT BAR PROFILES

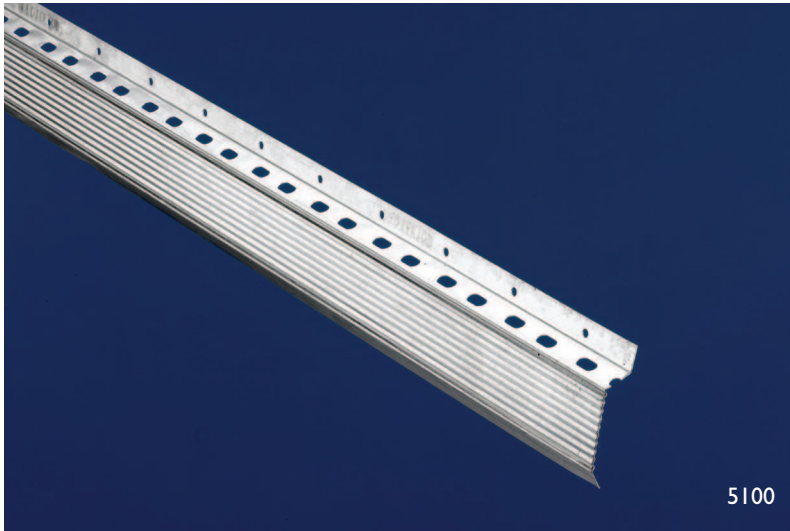

5100

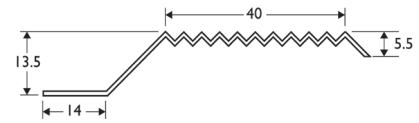

5007

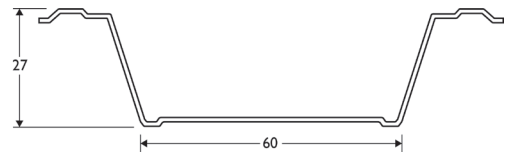

Protektor Resilient Bar Profiles are designed to improve the sound insulation of plasterboard walls and ceilings whether used in new build or in the improvement of existing constructions. The profile assists in isolating the plasterboard from the supporting surface hence reducing the area of contact and dissipating the level of sound transferring through the metal section.

DIN Standard profile 5007 is particularly effective when supporting a greater mass or weight of board (max 50 kilos/m²) to assist in achieving higher levels of acoustic performance.

Care should be taken to ensure that board fixings do not penetrate through the resilient bar into the timber joist as this will create flanking and reduce the performance of the profile.

PERFORMANCE

The choice of board will be dependent on the performance required for both fire and sound insulation. Reference should be made to the National Building Regulations Approved Document and Building Standards (Scotland) Regulations before commencement of work. The board manufacturer's data sheets also offer valuable detail.

METHOD OF BUILD

Fix resilient bars 90 degrees to stud work framing either to ceilings or walls. Fix with the narrow flange to the bottom and the fixing flange to the top using the desired fixing, with exception to the top bar which is fixed with the fixing flange at the bottom.

For single boarded systems install at 400mm centres, for double boarded systems install resilient bars at 600mm centres. When installing to ceilings install resilient bars at 400mm centres.

Where abutting door openings cut and install resilient bar noggins between horizontal bars to allow plasterboard to be fixed at the required centres.

GALVANISED STEEL

Ref	Description	Length (mtr)		Qty/Pack
		2.4	3.0	
5100	Standard Resilient Bar 40 mm x 13.5 mm x 0.6 mm	*	*	10
5007	DIN Standard Resilient Bar 60 mm x 27 mm x 0.6 mm		*	10

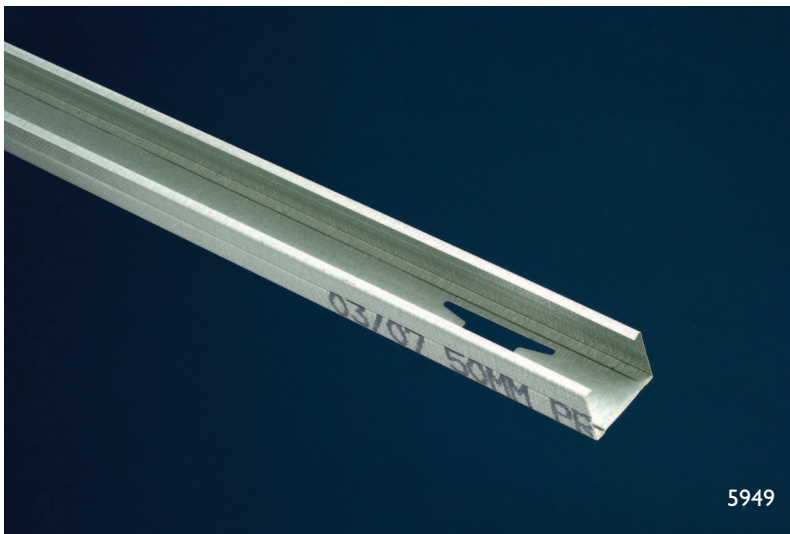

Protektor Eco Stud Partition profiles are a low cost, high quality metal friction fit construction used to form the support frame for non-load bearing plasterboard partitions.

Eco profiles are manufactured to the highest possible quality and fully conform with BS 7364: 1990. Specification for Galvanised steel stud work used in Partition's with screw fixed plasterboard. Stud profiles can be supplied in four differing widths and a variety of standard lengths to give a wider choice in the variety of builds and applications where required.

ECO C STUD PROFILES

Ref	Description	Length (mtr)					Qty/Bdl
		2.4	2.7	3.0	3.6	4.2	
5949	50 mm x 0.5 mm ECO C Stud Profile	•	•	•	•		10
5971	70 mm x 0.5 mm ECO C Stud Profile	•	•	•	•	•	10
5991	90 mm x 0.5 mm ECO C Stud Profile			•	•	•	10
59146	146 mm x 0.5 mm ECO C Stud Profile			•	•	•	10

ECO I STUD PROFILES

Ref	Description	Length (mtr)				Qty/Bdl
		3.0	3.6	4.2	5.0	
5949-I	50mm I Stud x 0.6mm	•	•			10
5971-I	70mm I Stud x 0.7mm	•	•	•		10
5991-I	92mm I Stud x 0.9mm		•	•		10
59146-I	146mm I Stud x 0.9mm		•	•	•	10

ECO U TRACK PROFILES

Ref	Description	Length (mtr)		Qty/Bdl
5851 / 30	52 mm x 0.5 mm Standard Track	3.0		10
5872 / 30	72 mm x 0.5 mm Standard Track	3.0		10
5892 / 30	92 mm x 0.5 mm Standard Track	3.0		10
5894 / 30	94 mm x 0.5 mm Standard Track	3.0		10
58148 / 30	148 mm x 0.5 mm Standard Track	3.0		10
5851 / 30-D	52 mm x 0.5 mm Deep Track	3.0		10
5872 / 30-D	72 mm x 0.5 mm Deep Track	3.0		10
5992 / 30-D	92 mm x 0.5 mm Deep Track	3.0		10
5994 / 30-D	94 mm x 0.5 mm Deep Track	3.0		10
58148 / 30-D	148 mm x 0.5 mm Deep Track	3.0		10
5851 / 30-ED	52 mm x 0.7 mm Extra Deep Track	3.0		10
5872 / 30-ED	72 mm x 0.7 mm Extra Deep Track	3.0		10
5992 / 30-ED	92 mm x 0.7 mm Extra Deep Track	3.0		10
58148 / 30-ED	148 mm x 0.7 mm Extra Deep Track	3.0		10

ECO C STUD

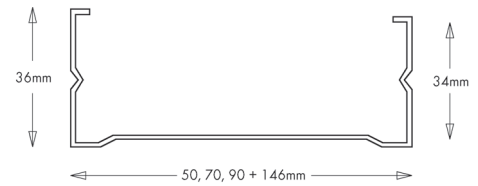

I STUD

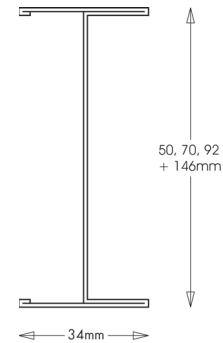

ECO TRACK

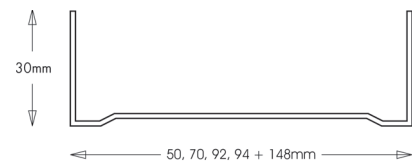

ECO DEEP TRACK

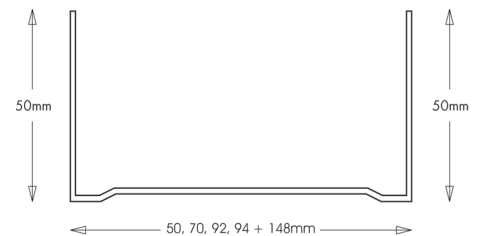

ECO EXTRA DEEP TRACK

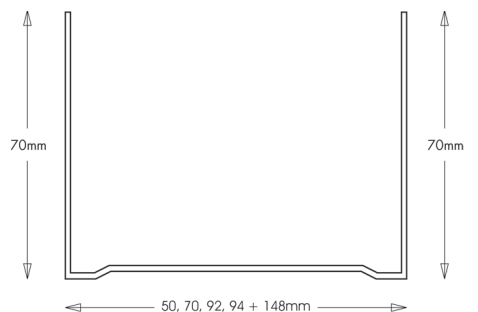

PERFORMANCE

The choice of board will be dependent on the performance required for both fire and sound insulation. Reference should be made to the National Building Regulations Approved Document and Building Standards (Scotland) Regulations before commencement of works. The board manufacturer's data sheets also offer valuable detail.

SOUND INSULATION

High acoustic performance is generally associated with greater mass (i.e. multi-layers of board). Extra mineral wool, insulation and acoustic sealant may be required to meet the regulations. Reference to the board manufacturer's data sheets is recommended.

FIRE RATING

A fire rating is achieved by a combination of type of board used, number of layers of board and insulation. Refer to manufacturer's data sheets. Protektor MF metal components are non-combustible when tested in accordance with BS476: Part 4: 1970.

METHOD OF BUILD

The Eco U Track should be screw fixed to the floor along the line of the planned new partition. The head track should be fixed to the structural soffit vertically in line with the floor track.

The Eco C Studs should now be cut to the vertical height (less 10mm - to allow for any movement or disparity in the floor levels). Place the studs into the Eco U Track and twist to lock into place. The open mouth of the C Stud should all face in the same direction. If you are intending to board out using plasterboard of 10mm thickness or less - the studs should be set out in the track at 400mm centres. If the board has a thickness of 12.5mm or greater - the studs should be set out at 600mm centres unless otherwise stated.

If insulation is specified, use Insulation Hold Strips, screw-fixed or crimped to the studs profiles 150mm from the partition head and at 1200mm vertical centres down the partition.

Movement control joints may be required to relieve normal structural movement without loading the partition. Movement control joints are required in partitions at intervals not exceeding 10m, where the partition crosses or abuts a structural Movement joint, and where partitions of dissimilar materials meet in the same plane.

The installation of electrical services should be carried out in accordance with the recommendations of the Institution of Electrical Engineers. The knock-outs in the studs can



be used for routing electrical and other small services. Cables should be protected by conduit or other suitable precautions taken to prevent abrasion when they pass through the metal frame. Where possible we always recommend using Protektor acoustic felt under the U profiles to reduce the possibility of flanking sound transmission and act as a smoke stop in fire situations.

When creating doorways within a partition wall we would recommend that full length stud profiles (with timber inserts where required) fixed to both floor and head track either side of the opening. Track profile should then be cut and placed at the head of the doorway and fixed to each vertical stud on both sides.

The contractor should add a minimum of 5-7mm to both the overall width and height of the proposed door to allow for easier fixing and adjustment of the door carcass. Where a heavy fire or acoustic door is required the method of construction may change, with heavier reinforcement than timber.

MAXIMUM BUILD HEIGHTS

Each Eco Stud has a maximum build height when set out at 600mm centres. This is dependant also on the number of layers of board and the chart below indicates the perimeters you can safely work within. You can build higher by reducing the centres of the studs or by boxing two studs together. For advice on this please contact our technical office.

WALL CONSTRUCTION

Stud profiles @ 600 mm cts	Build Height (m)			
	5949	5971	5991	59146
1 x 12.5 mm Plasterboard	2.5	3.6	3.9	4.2
1 x 15 mm Plasterboard	2.8	3.8	4.2	4.8
2 x 12.5 mm Plasterboard	3.4	4.6	4.7	5.6
2 x 15 mm Plasterboard	3.7	4.9	5.0	5.9

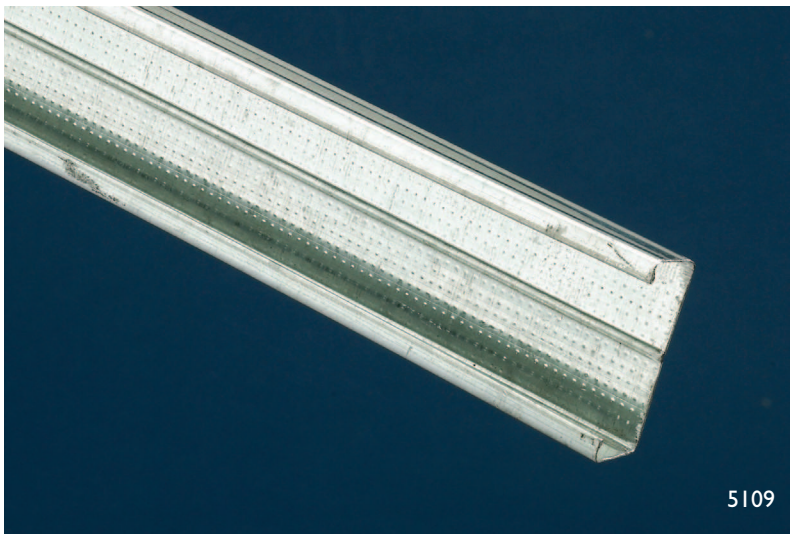

Protektor wall lining profiles provide a quick, simple and cost-effective way to dry line masonry backgrounds, uneven walls, walls with surface-fixed services. Used internally in commercial and domestic applications the profiles are suitable for fixing all types of plasterboard creating a seamless surface that will receive most decorative finishes.

Once fixed with secure mechanical fixings the profiles can easily accommodate surface mounted services whilst incorporating mineral wool in the cavity to meet thermal or acoustic insulation requirements. Walls should be treated for damp, prior to installation where required.

PERFORMANCE

The choice of board will be dependent on the performance required for both fire and sound insulation. Reference should be made to the National Building Regulations Approved Document and Building Standards (Scotland) Regulations before commencement of work. The board manufacturer's data sheets also offer valuable detail.



GALVANISED STEEL

Ref	Description	Length (mtr)			Quantity/pack
		2.4	3.0	3.6	
5109	CD Profile 47 mm x 17 mm x 0.6 mm	*	*	*	12
PP20	U Perimeter / Track Profile			*	10
6120	95 mm Timber Hanger				100
6121	190 mm Timber Hanger				100
6125	CD Profile Connector				50
6166	125 mm Direct Fix Hanger				100
6168	75 mm Direct Fix Hanger				100

METHOD OF BUILD

CEILING INSTALLATION:

Strike a level line around perimeter walls ready for installation of perimeter channels.

Fix perimeter channels at the required height, fixing 50mm from each end and at every 600mm using a suitable fixing.

Install U brackets to soffit using a suitable top fixing making sure that the bracket centres are set out to meet the required load.

Bend bracket legs down, these can either be cut off or bent back to the desired ceiling height (top of perimeter channel).

Insert lining channel into perimeter channel in line with the fixing brackets, fix together the bracket and lining channel using the appropriate fixing.

Where lining channels require joining use connector clips making sure all joints are staggered by minimum of 600mm.



WALL LINING INSTALLATION:

Strike straight parallel lines on the floor and soffit, making sure that the required cavity depth can be achieved.

Fix perimeter channel with kinked leg positioned closest to the cavity allowing the plasterboard to be fixed to the long leg. Use suitable fixings and fix 50mm from each end and then every 600mm.

Mark vertical lines to indicate lining stud centres taking into account specification and desired loadings (600mm, 400mm, 300mm).

Mark horizontal lines across vertical lines, where both lines cross this will indicate bracket locations, taking into account specification and desired loadings (1200mm, 800mm, 600mm, 400mm).

Fix U brackets using the appropriate fixing where both lines cross.

Cut to size lining channel and insert into perimeter channels, level and fix together lining channel and bracket leg using suitable fixings to both sides of the lining channel.

Cut off or bend back bracket so that it does not fail the back face of plasterboard.

Where lining channels are to be extended, use connector clips to make sure that all joints are staggered to a minimum of 600mm.



The Protektor MF Ceiling System is designed for use in most commercial applications.

Whilst being an economical cost effective system, it still retains the quality of manufacture associated with the Protektor brand.

All the components meet or surpass current British and European standards and as such the contractors can construct a suspended ceiling with confidence.

PERFORMANCE

The choice of board will be dependent on the performance required for both fire and sound insulation. Reference should be made to the National Building Regulations Approved Document and Building Standards (Scotland) Regulations before commencement of works. The board manufacturer's data sheets also offer valuable detail.



GALVANISED STEEL

Ref	Description	Size mm	Length (mtr)	Quantity / box
PP5	Furring Channel		3.6	10
PP6	Edge Channel		3.6	10
PP7	Primary Channel	0.8	3.6	10
PP8	Strap Hanger		25m	
PP9	Connecting Clip			200
PP10	Angle Profile	25 x 25 x 0.80	3.6	20
5161	Angle Profile	25 x 25 x 0.60	3.0	20

GALVANISED STEEL

Ref	Description	Size mm	Length (mtr)	Quantity / box
PP11	MF Nuts & Bolts			200
PP12	Cleats / Brackets			100
PP13	Acoustic Hanger	35		100
PP14	Acoustic Hanger	70		100
PP15	Primary Channel	1.2	3.6	10
6239	Steel Framing Screw	4.2mm x 13mm		1000

SOUND INSULATION

High acoustic performance is generally associated with greater mass (i.e. multi-layers of board). Extra mineral wool, insulation and acoustic sealant may be required to meet the regulations. Reference to the board manufacturer's data sheets is recommended.

FIRE RATING

A fire rating is achieved by a combination of type of board used, number of layers of board and insulation. Refer to manufacturer's data sheets. Protektor MF metal components are non-combustible when tested in accordance with BS476: Part 4: 1970.

A quality intumescent sealant should be used when sealing all perimeters.

METHOD OF BUILD

Fix the perimeter edge channel at 600mm centres starting 50mm from the end of the channel, with appropriate fixings to the walls at the required height of the proposed ceiling.

Attach the Protektor soffit cleat to the structural soffit. Suspend the metal ceiling frame from the soffit cleats with Protektor angle or strap hangers. Fix the metal angle strap hangers to the Protektor primary channel with two pan head screws.

The angle strap hangers should be spaced at 1200mm along the length of each primary channel.

The centres of the primary channels are dependent upon the total loadings once the ceiling is completed.

Fix the Protektor ceiling furring channel at right angles to the primary channels and secure using Protektor connecting clip. Be sure to fix ceiling channels with pan head screws when a double layer of ceiling boards are required.

Hook the clips to the flange of the ceiling channel and snap fix onto the primary channel. The ceiling channel centres should be no greater than 450mm.

The chosen board can now be screw fixed to the frame. Refer to board manufacturers guidelines and data sheets for details.

The primary channel can be joined together by placing the two pieces back to back (overlap 150mm) and bolting together.

The ceiling channel is joined together by overlapping inside each other by 150mm and secured by crimping or screwing twice both sides of the overlap.

CEILING CONSTRUCTION

Hanger Centres (mm)	Primary Channel Centres (mm)	Max. Load inc. Board (kg/sq.m)
1200	600	70
1200	900	48
1200	1200	32

APPLICATION DETAILS

Section through ceiling. Basic Assembly

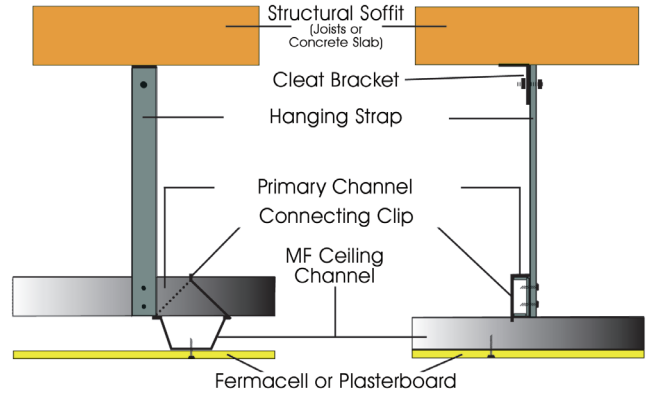

ABUTMENT TO WALL

Support for the ceiling channel is supplied by the perimeter channel screw fixed to the wall

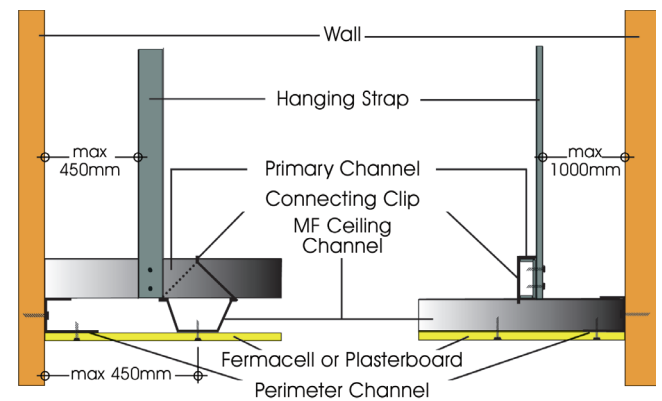

ELEMENTS OF CONSTRUCTION

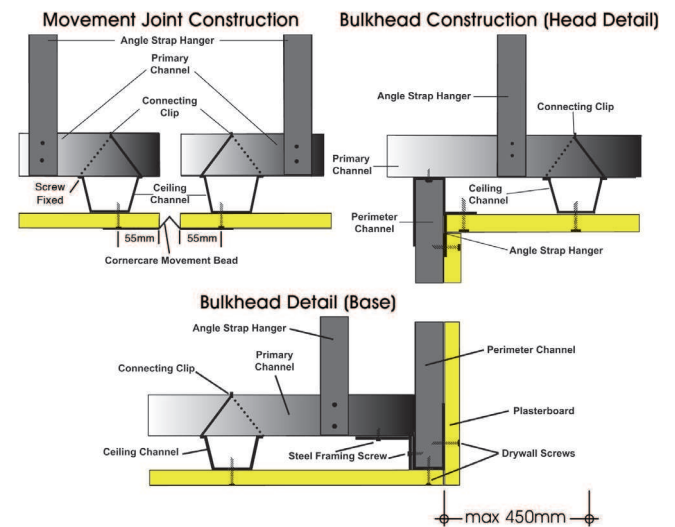

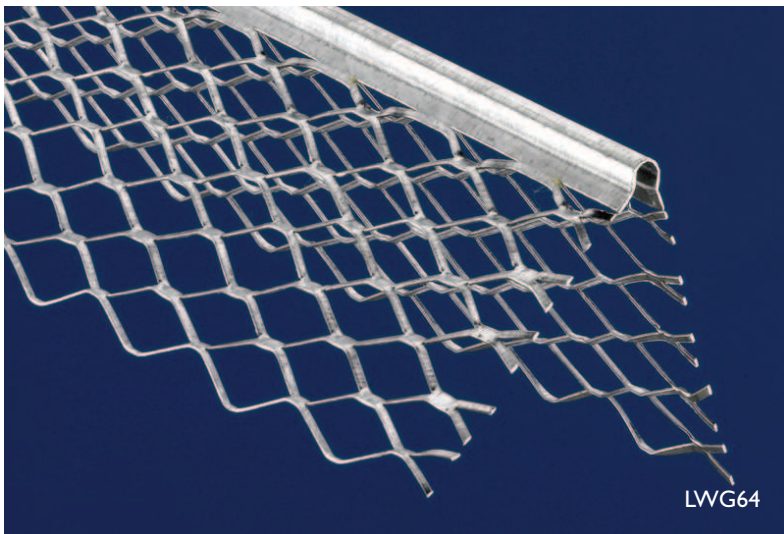

Protektor Angle Beads provide a true, straight arris that protects and reinforces plaster where it is most vulnerable. The expanded metal wings ensure that the bead is firmly embedded in the plaster.

ABG / ABS 47mm Standard Angle Bead

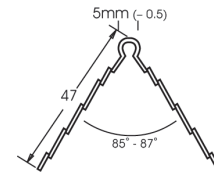

LWG53 / LWS53 53mm Long Wing Angle Bead

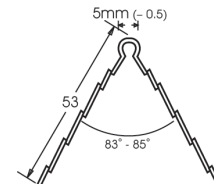

MAX55 55mm Long Wing Angle Bead

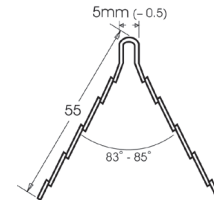

LWG64 / LWS64 64mm Long Wing Angle Bead

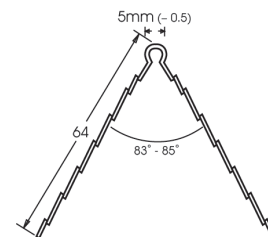

I046 45mm c/w PVCu Nose Angle Bead

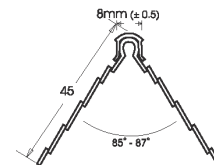

GALVANISED STEEL

Ref	Description	Length (mtr)			Quantity/box
		2.4	2.7	3.0	
ABG	47mm Standard	•	•	•	50
LWG53	53mm Long Wing	•		•	50
MAX55	55mm Long Wing			•	50
LWG64	64mm Long Wing			•	25
I046	45mm c/w PVCu Nose			•	25

STAINLESS STEEL

ABS	47mm Standard			•	25
LWS53	53mm Long Wing			•	25
LWS64	64mm Long Wing			•	25

STOP BEAD

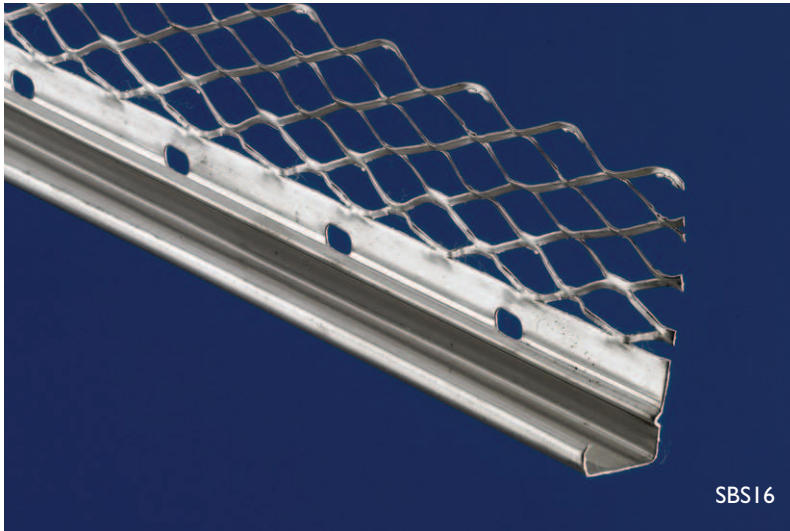

SBS16

Protektor's Stop Bead profile provides the ideal answer to finishing the edges of plaster/render work. The straight edge of the profile ensures an accurate finish line whilst protecting the plaster where it is most vulnerable.

SBG10 / SBS10 10mm Stop Bead

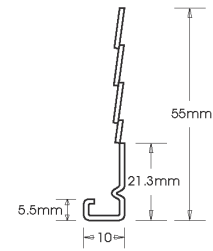

SBG13 / SBS13 13mm Stop Bead

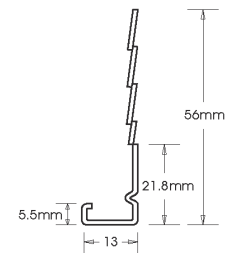

SBG16 / SBS16 16mm Stop Bead

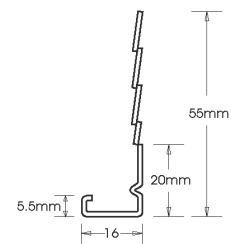

SBG19 / SBS19 19mm Stop Bead

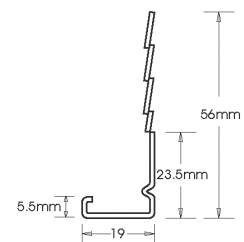

GALVANISED STEEL

Ref	Description	Length (mtr)			Quantity/box
		2.4	2.7	3.0	
SBG10	10mm Stop Bead	•	•	•	50
SBG13	13mm Stop Bead	•	•	•	50
SBG16	16mm Stop Bead	•		•	25
SBG19	19mm Stop Bead	•		•	25

STAINLESS STEEL

SBS10	10mm Stop Bead			•	25
SBS13	13mm Stop Bead			•	25
SBS16	16mm Stop Bead			•	25
SBS19	19mm Stop Bead			•	25

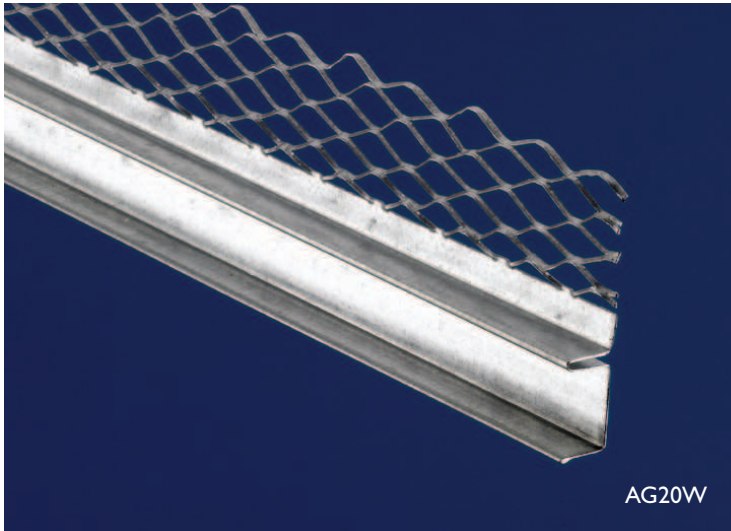

AG20W

Protektor Architrave Beads are designed to act as a plaster stop profile whilst creating a shadow-like recess around door frames, ceilings and varying wall finishes.

The Architrave Bead will increase the speed of installation and finishing process dramatically.

AG3010 10mm Architrave without Return

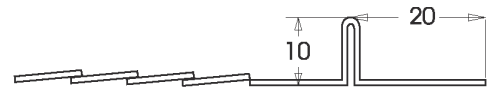

AG3013 13mm Architrave without Return

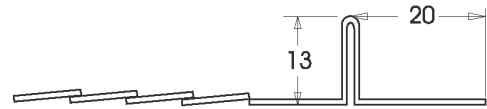

AG3010W / AS3010W 10mm Architrave with Return

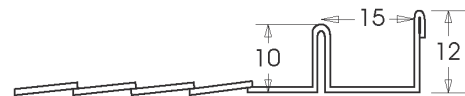

AG3013W / AS3013W 13mm Architrave with Return

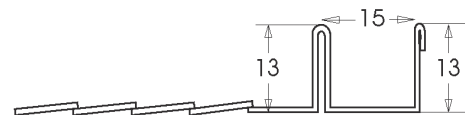

AG20W / AS20W 13mm Architrave with 20mm Return

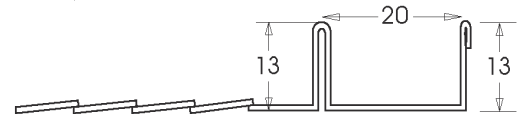

AG25W / AS25W 13mm Architrave with 25mm Return

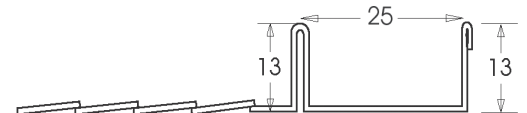

AG30W / AS30W 13mm Architrave with 30mm Return

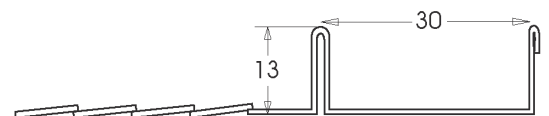

GALVANISED STEEL

Ref	Description	Length (mtr) 3,0	Qty/box
AG3010	10mm Architrave without Return	•	25
AG3010W	10mm Architrave with Return	•	25
AG3013	13mm Architrave without Return	•	25
AG3013W	13mm Architrave with Return	•	25
AG20W	13mm Architrave with 20mm Return	•	25
AG25W	13mm Architrave with 25mm Return	•	25
AG30W	13mm Architrave with 30mm Return	•	25

STAINLESS STEEL

AS3013W	13mm Architrave with Return	•	25
AS20W	13mm Architrave with 20mm Return	•	25
AS25W	13mm Architrave with 25mm Return	•	25
AS30W	13mm Architrave with 30mm Return	•	25

BELL CAST BEAD

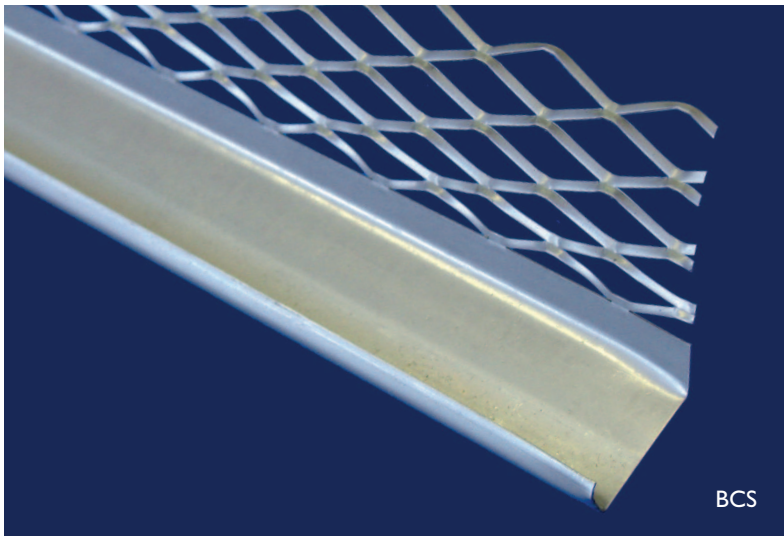

BCG16 / BCS16 16mm Bell Cast Render Stop Bead

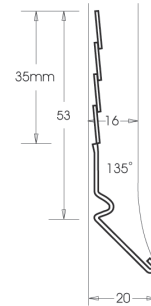

BCG / BCS 20mm Bell Cast Render Stop Bead

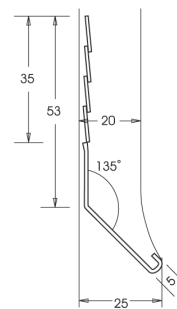

Protektor Render Stop Bead profiles provide the ideal answer to finishing the lower edges of render work.

The Bell Cast External Render Stop Bead, when used correctly, will assist in creating a bell finish which will allow rainwater to run-off from the surface of the wall.

Both profiles provide a straight line that will protect and reinforce the render. Care should be taken during the application to ensure that the profile is set out level and also that the bead does not get damaged. When render needs to be cleaned off, we recommend that this should be done while it is still wet.

GALVANISED STEEL

Ref	Description	Length (mtr)			Quantity/box
		2.4	2.7	3.0	
BCG16	16mm Bell Cast Render Stop Bead			•	25
BCG	20mm Bell Cast Render Stop Bead	•	•	•	25

STAINLESS STEEL

BCS16	16mm Bell Cast Render Stop Bead			•	25
BCS	20mm Bell Cast Render Stop Bead			•	25

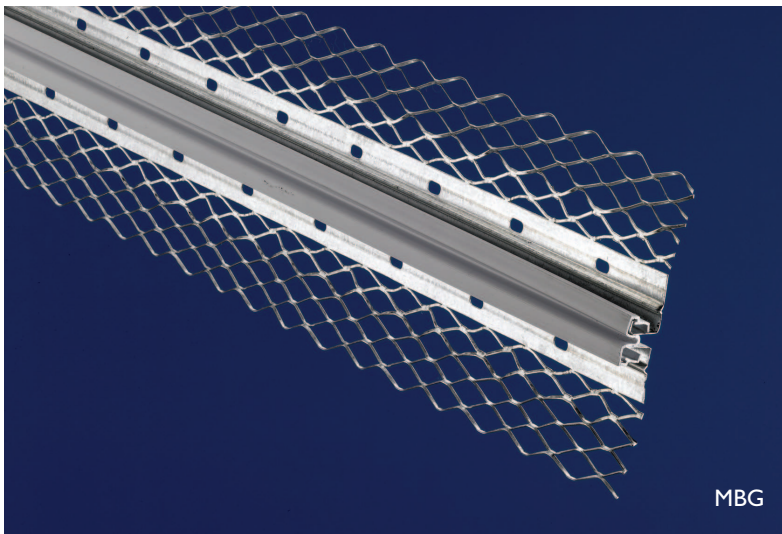

Protektor Movement Bead provides a solution to thermal movement in plaster and rendered finishes.

When placed vertically at predetermined centres, the profile will provide 6mm movement, hence reducing the possibility of cracking. The face of the extrusion is covered by a black PVC tape; to be removed when the plaster or render work has been completed.

MBG3010 / MBS3010 10mm Movement Bead

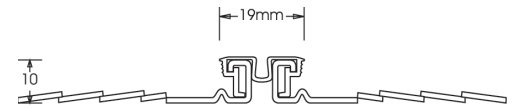

MBG3013 / MBS3013 13mm Movement Bead

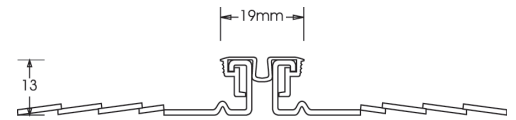

MBG3016 / MBS3016 16mm Movement Bead

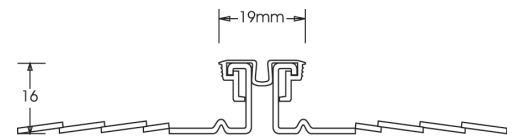

MBG3019 / MBS3019 19mm Movement Bead

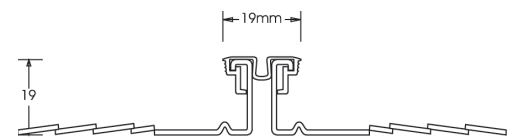

GALVANISED STEEL

Ref	Description	Length (mtr)	Quantity/box
		3.0	
MBG3010	10mm Movement Bead	•	10
MBG3013	13mm Movement Bead	•	10
MBG3016	16mm Movement Bead	•	10
MBG3019	19mm Movement Bead	•	10

STAINLESS STEEL

MBS3010	10mm Movement Bead	•	10
MBS3013	13mm Movement Bead	•	10
MBS3016	16mm Movement Bead	•	10
MBS3019	19mm Movement Bead	•	10

INTERNAL CORNER MOVEMENT BEAD



IMB3013

The Protektor Internal Corner Movement Bead provides a solution to thermal movement in plaster and rendered finishes. The profile, when placed vertically on the internal corner will allow up to 6mm movement reducing the possibility of cracking. After the plaster/render work has been completed the PVC link at the face of the joint should be broken carefully to allow the joint to move freely (Fig. 1).

Care should be taken not to rip the soft duplex extrusion at the rear of the joint during this stage.

Fig. 1

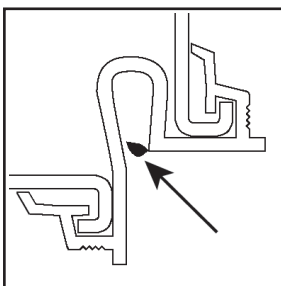

IMG3010 / IMS3010 10mm Internal Corner Movement Bead

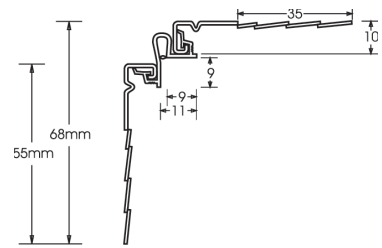

IMG3013 / IMS3013 13mm Internal Corner Movement Bead

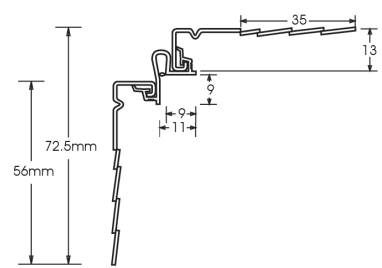

IMG3016 / IMS3016 16mm Internal Corner Movement Bead

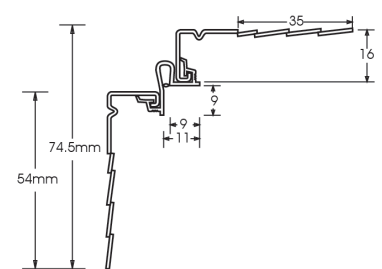

IMG3019 / IMS3019 19mm Internal Corner Movement Bead

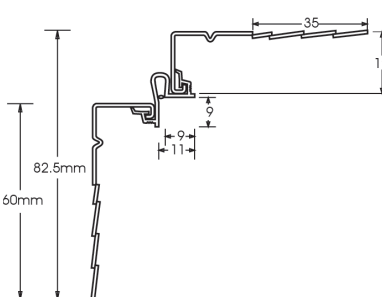

GALVANISED STEEL

Ref	Description	Length (mtr)	Quantity/box
IMG3010	10mm Internal Corner Movement Bead	3.0	10
IMG3013	13mm Internal Corner Movement Bead	•	10
IMG3016	16mm Internal Corner Movement Bead	•	10
IMG3019	19mm Internal Corner Movement Bead	•	10

STAINLESS STEEL

IMS3010	10mm Internal Corner Movement Bead	•	10
IMS3013	13mm Internal Corner Movement Bead	•	10
IMS3016	16mm Internal Corner Movement Bead	•	10
IMS3019	19mm Internal Corner Movement Bead	•	10

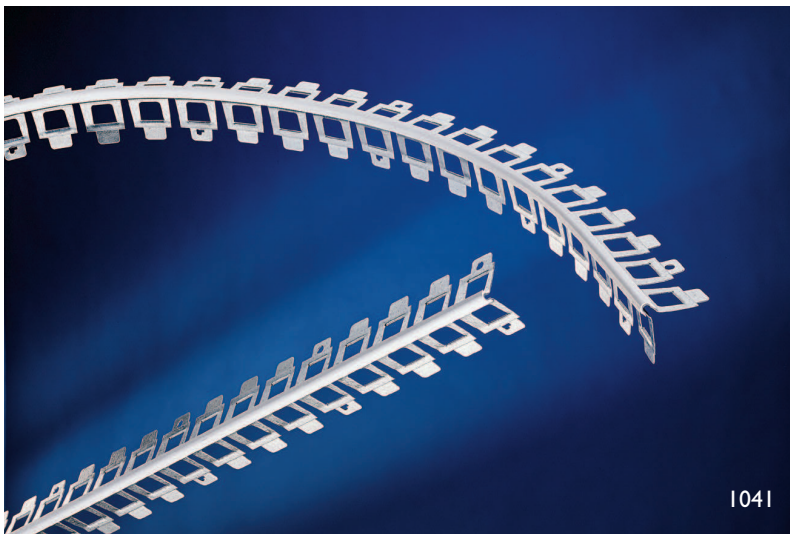

Protektor Render Profiles are specifically designed for render finishes ranging from 10mm to 20mm thick.

The profiles, manufactured from 0.6mm galvanised steel, are rigid and ideally suited for quick installation.

All profiles have a white PVCu extruded nosing, which provides protection to the arris/edge of the profile during installation.

1020

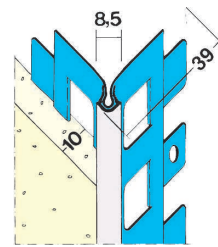

1019

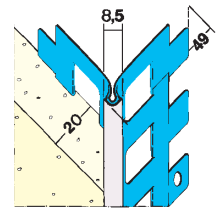

1224

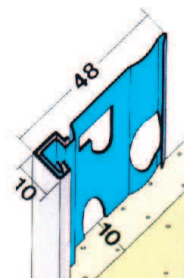

1223

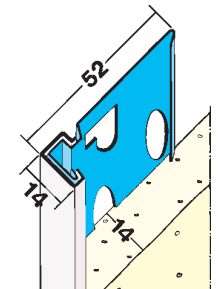

1041

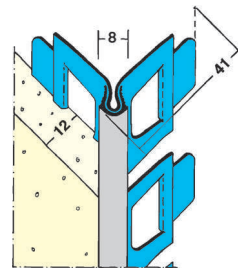

1229

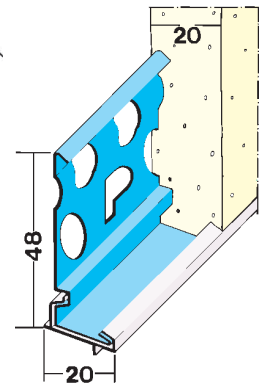

GALVANISED STEEL

Ref	Description	Length (mtr)		Quantity/box
		2.5	3.0	
1020	10mm Angle Bead		•	15
1019	20mm Angle Bead		•	15
1041	12mm Angle Bead	•		15
1224	10mm Stop Profile		•	25
1223	14mm Stop Profile		•	25
1222	20mm Stop Profile		•	25
1227	10mm Render Stop		•	25
1225	14mm Render Stop		•	25
1229	20mm Render Stop		•	25

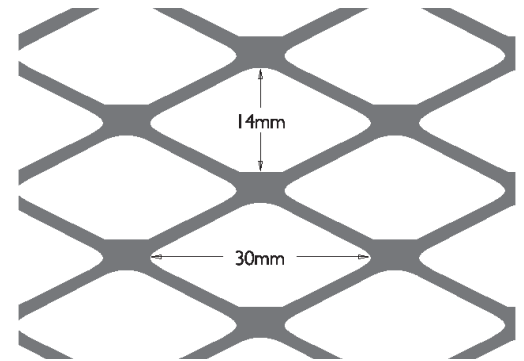
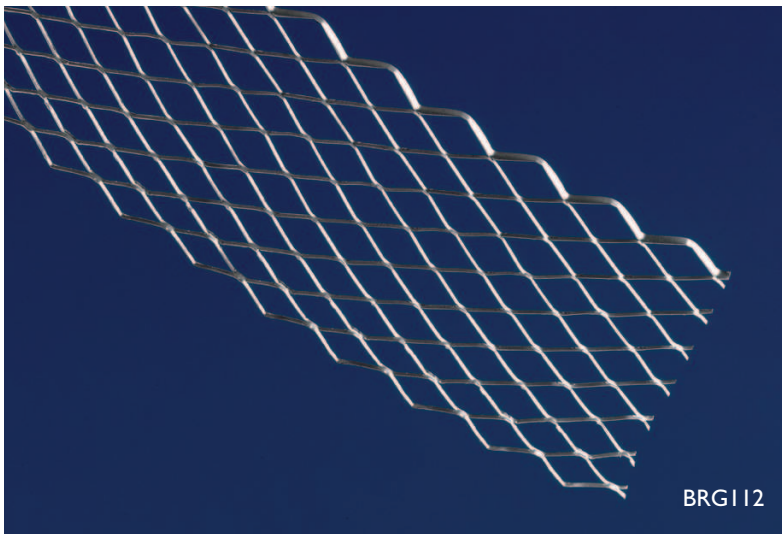

INTERNAL WALLS

Galvanised Reinforcement Coil is used for inner leaf work; manufactured from galvanised steel to BS EN 10327 - DX51D + Z275

EXTERNAL WALLS

Stainless steel Reinforcement Coil is used for inner leaf work; manufactured from BS EN 10088-2-1/4301

Protektor Expanded Reinforcement Coil has numerous applications in all types of buildings where additional strength is required within the coarse work.

Coil mesh when embedded in the mortar joint forms an integral structure of great tensile strength which will assist in the resistance to stresses, vibrations and thermal changes and will assist in reducing cracking within brick and block masonry.

A wide variety of sizes are available which will satisfy most wall thicknesses, laid on the mortar bed with 25mm clearance to the outside face of the wall and lapped at least 75mm when joining lengths. The reinforcement is then embedded completely and for most applications every third coarse for the full length of the wall is sufficient.

GALVANISED STEEL

Ref	Nominal Material Thickness	Nominal Mesh Size	Nominal Kilos per M ²	Size (Roll Width x Length)
BRG6120	0.5mm	14mm x 30mm	0.91	61mm x 20mtr
BRG11220	0.5mm	14mm x 30mm	0.91	112mm x 20mtr
BRG17820	0.5mm	14mm x 30mm	0.91	178mm x 20mtr
BRG22820	0.5mm	14mm x 30mm	0.91	228mm x 20mtr
BRG30520	0.5mm	14mm x 30mm	0.91	305mm x 20mtr
BRG6110	0.5mm	14mm x 30mm	0.91	61mm x 100mtr
BRG10010	0.5mm	14mm x 30mm	0.91	100mm x 100mtr
BRG11210	0.5mm	14mm x 30mm	0.91	112mm x 100mtr
BRG15010	0.5mm	14mm x 30mm	0.91	150mm x 100mtr
BRG17810	0.5mm	14mm x 30mm	0.91	178mm x 100mtr
BRG20010	0.5mm	14mm x 30mm	0.91	200mm x 100mtr
BRG22810	0.5mm	14mm x 30mm	0.91	228mm x 100mtr
BRG30510	0.5mm	14mm x 30mm	0.91	305mm x 100mtr

STAINLESS STEEL

BRS6120	0.5mm	14mm x 30mm	0.91	61mm x 20mtr
BRS11220	0.5mm	14mm x 30mm	0.91	112mm x 20mtr
BRS17820	0.5mm	14mm x 30mm	0.91	178mm x 20mtr
BRS22820	0.5mm	14mm x 30mm	0.91	228mm x 20mtr
BRS30520	0.5mm	14mm x 30mm	0.91	305mm x 20mtr

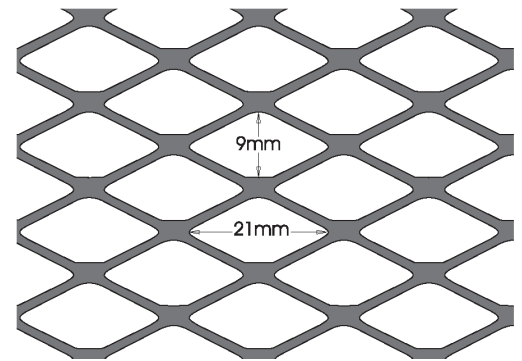
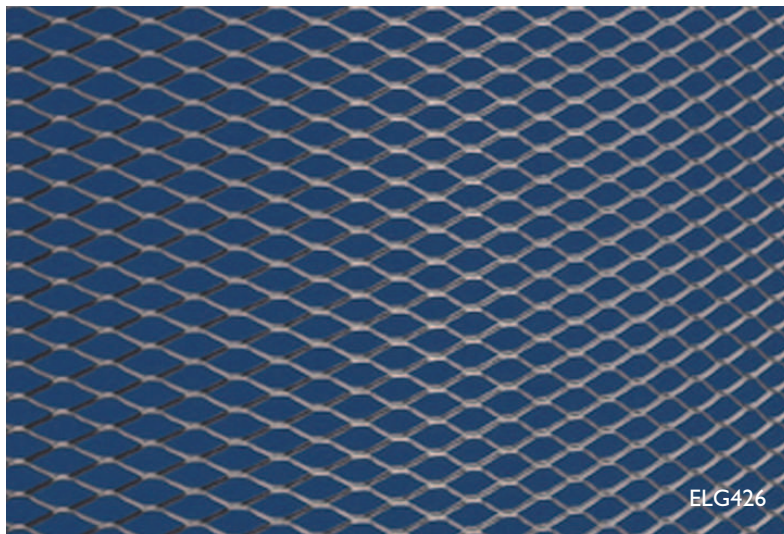

Protektor's Expanded Metal Lathing and Mesh products are used to provide a suitable key for plaster and rendered finishes including joint and crack reinforcement and general refurbishment.

Easy to install and fix, expanded metal can be used to provide reinforcement for curved surfaces and steel columns where fire protection is required.

Areas such as suspended ceilings where longer spans are required between steel supports, require a lath of 1.69 kilos per m² nominal weight to BS1369 Part 1: 1987.

GALVANISED STEEL METAL LATH SHEETS

Ref	Nominal Material Thickness	Nominal Mesh Size	Nominal Kilos per M ²	Size (Roll Width x Length)
ELG428	0.4mm	9mm x 21mm	0.91	2440mm x 685mm
ELG426	0.5mm	9mm x 21mm	1.15	2440mm x 685mm
ELG425	0.6mm	9mm x 21mm	1.40	2440mm x 685mm
ELG424	0.7mm	9mm x 21mm	1.63	2440mm x 685mm
ELG420	0.9mm	9mm x 21mm	2.62	2440mm x 685mm

STAINLESS STEEL METAL LATH SHEETS

ELS426	0.5mm	9mm x 21mm	1.15	2440mm x 685mm
--------	-------	------------	------	----------------

GALVANISED STEEL METAL LATH ROLLS

BMG10010	0.4mm	9mm x 21mm	0.91	100mm x 100m
BMG15010	0.4mm	9mm x 21mm	0.91	150mm x 100m
BMG20010	0.4mm	9mm x 21mm	0.91	200mm x 100m

GALVANISED STEEL STRIP MESH

SMG100	0.5mm	9mm x 21mm	1.93	2400mm x 100m
SMG150	0.5mm	9mm x 21mm	1.93	2400mm x 150m
CMG50x50	0.5mm	9mm x 21mm	1.93	2400mm x 50m x 50m

STAINLESS STEEL STRIP MESH

SMS100	0.5mm	9mm x 21mm	1.93	2400mm x 100m
SMS150	0.5mm	9mm x 21mm	1.93	2400mm x 150m
CMS50x50	0.5mm	9mm x 21mm	1.93	2400mm x 50m x 50m

RIBLATH

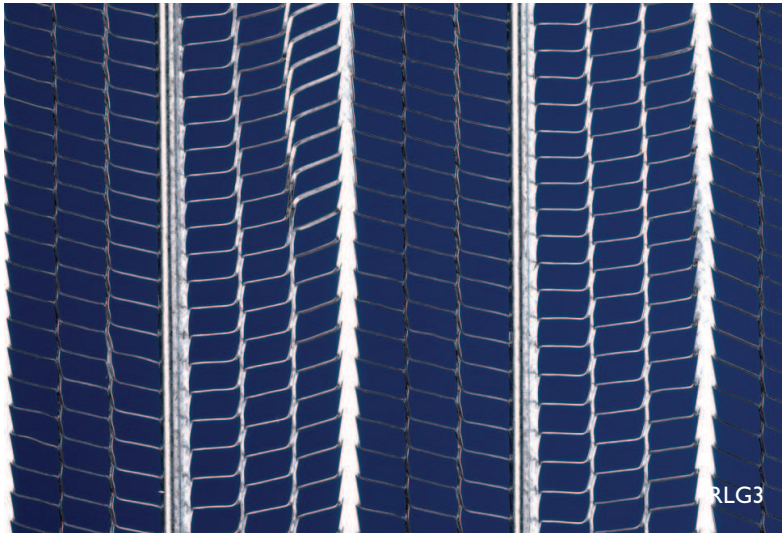

Riblath is an integrally ribbed expanded metal lath available in two steel thicknesses, 0.3mm thick and 0.5mm thick, for the construction of suspended ceilings, walls and stud partitions.

Render-Rib is used as a backing and reinforcement for external render including thermal insulation render system, rough cast, stucco and masonry veneer.

The stainless steel Riblath meets with the requirements of BS 5262, 1976 Code of Practice for External Rendering.

All stainless steel Riblath is manufactured from BS EN 10088-2-1/4301 and produced in accordance with BS1369: Part 1:1987- Part 1.

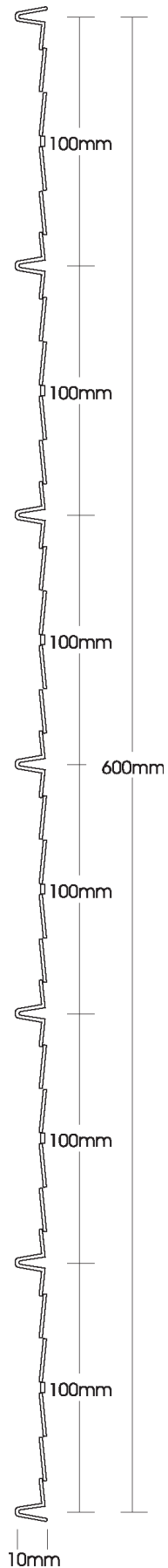

GALVANISED STEEL

Product Code	Rib Depth	Nominal Kilos/M2	Nominal Mat. Thickness	Sheet Size mm
RLG3	10mm	1.15	0.3mm	2500 x 600
RLG5	10mm	1.78	0.5mm	2500 x 600
RRG5	10mm	1.78	0.5mm	2500 x 600

STAINLESS STEEL

RLS3	10mm	1.15	0.3mm	2500 x 600
------	------	------	-------	------------



The Protektor range of Security Mesh is specifically designed for use within partitions, ceilings, walls and roofing constructions to deter or prevent illegal entry into areas such as secure Cash Rooms, IT Centres, drug storage or high value goods storage areas.

Easily installed, the Security Meshes can be used within plasterboard constructions or on blockwork and then plastered or rendered thereafter.

Protektor galvanised perforated security panels are used externally when covering windows or doorways preventing illegal entry to properties in the process of refurbishment. The panels can be re-used on other construction sites requiring total security and protection against vandalism once the property has been completed.

FIXING ADVICE

When installing Security Mesh the sheets should be butted together and not overlapped.

FIXING SECURITY MESH TO TIMBER JOISTS

38 – 45mm zinc coated screws should be used with 25mm x 1.5mm galvanised washers at 450mm centres.

FIXING SECURITY MESH TO PROTEKTOR STEEL PARTITION PROFILES

6/8 x 32mm or 38mm dry wall screws should be used with 25mm x 1.5 mm galvanised washers at 450mm centres.

FIXING SECURITY PANELS TO TIMBER FRAMES

45 – 57mm zinc coated screws should be used at 450mm centres. After installation the screw heads should be ground so as to prevent easy removal of the fixings.

For increased or high security performance, heavier weighted meshes should be used and fixing centres reduced. Please refer to the Protektor Technical Office for steel profile recommendations.

GALVANISED STEEL

Ref	Description	Size (nominal)	Finished Thickness (kilos)	Weight per m2
SEC-1	Heavy Duty Mild Steel Expanded Security Mesh	2440mm x 1220mm	3.0mm	8.59
SEC-2	Medium Duty Mild Steel Expanded Security Mesh	2440mm x 1220mm	1.85mm	3.19
SEC-3	Light Duty Mild Steel Expanded Security Mesh	2440mm x 1220mm	1.25mm	1.85

MATERIALS

Protektor Galvanised Bead for Plaster, Plasterboard and Render.

Protektor Galvanised Expanded Brick Reinforcement and Expanded Lath.

Manufactured from Galvanised Steel to BS EN 10327 - DX51D+275.

Protektor Stainless Steel Bead.

Protektor Stainless Steel Expanded Brick Reinforcement/Expanded Lath.

Manufactured from Austenitic Stainless Steel to BS EN 10088-2 grade 1.4301.

Protektor Galvanised Dry Wall Profiles for Ceilings and Partitions.

Manufactured from Galvanised Steel to BS EN 10327 - DX51D.

Protektor Security Mesh.

Manufactured from Cold Rolled Mild Steel to BS EN 10130: 1991 (SEC2 & 3), and HRP&O Mild Steel to BS EN 10111:1998 (SEC1).

SPECIFICATION/BRITISH STANDARD

BS EN 13658-1:2005 - Metal lath and beads - Definitions, requirements and test method, Part 1: Internal plastering.

BS EN 13658-2:2005 - Metal lath and beads - Definitions, requirements and test method, Part 2: External rendering.

BS EN 13914-1:2005 - Design, preparation and application of external rendering and internal plastering, Part 1: External rendering.

BS EN 13914-2:2005 - Design, preparation and application of external rendering and internal plastering, Part 2: Design considerations and essential principals for internal plastering.

BS 8212: 1995 - Code of Practise for Dry Lining and Partitioning using Gypsum Plasters.

BS 7364: 1990 - Specification for galvanised steel studs and channels for studs and sheet partitions and linings using screw fixed gypsum boards.

INSTALLATION OF BEADS

Choose your Beads to suit their application internal/external and the plaster/render thickness to be used. If it is necessary to cut the beads to length, the nose of the bead should be cut with a fine tooth saw and the wings with tinman's shears. To join two lengths of bead, a dowel can be made and inserted in the hollow of the bead to ensure a true alignment.

Fixing beads within plasterwork: fixing is quick and simple. Apply dabs at 600mm centres then press the expanded/perforated wings into the plaster dabs. The bead is then plumbed and squared sufficiently to ensure the required thickness of plaster. Beads may also be fixed with galvanised/stainless steel nails or wire-tied when used on metal lath.

Fixing Beads with Render: fixing is generally as described above, it is important that render is used for dab fixing and not plaster. When stainless steel beads are being fixed with nails, these should be in stainless steel and stainless steel wire should be used when tying stainless steel lathing.

DELIVERY/STORAGE

Protektor's efficient manufacturing and consistent levels of stock ensure a fast, prompt response to our customers. The products are normally supplied strapped or banded for transport and storage purposes. They can be off-loaded mechanically using a suitable forklift truck. Store under cover in clean, dry conditions, out of contact with dry cement, lime, plaster or mortar. The Plaster Beads should be stacked flat and supported along their length. (Full boxes should not be stacked more than six high).

SAFETY PRECAUTIONS

When cutting plaster/render beads, expanded metal lathing and brick reinforcement, we recommend the wearing of gloves. Individuals with existing skin problems or those sensitised to mineral oils should protect their hands using a skin barrier cream or suitable gloves. If irritation or injury occurs, seek medical attention.

PROTEKTOR

SOUTHERN OFFICE

Protektor UK Limited,
Protektor House,
Frederick Road,
Hoo Farm Industrial Estate,
Kidderminster,
Worcestershire,
England, DY11 7RA

Tel: 01562 515200

Fax: 01562 515116

NORTHERN OFFICE

Protektor UK Limited,
10 Carlyle Avenue,
Hillington Park,
Glasgow,
Scotland, G52 4JJ

Tel: 0141 810 4411

Fax: 0141 810 4414

Sales Enquiries: sales@protektor.co.uk

Technical Queries & Support: technical@protektor.co.uk

Website: www.protektor.co.uk

