

3941348COM Wardrobe - Reclaimed oak

**NOV
OGR
ATZ**

Date of Purchase ___/___/___
Lot Number:

B343941348COM00KX

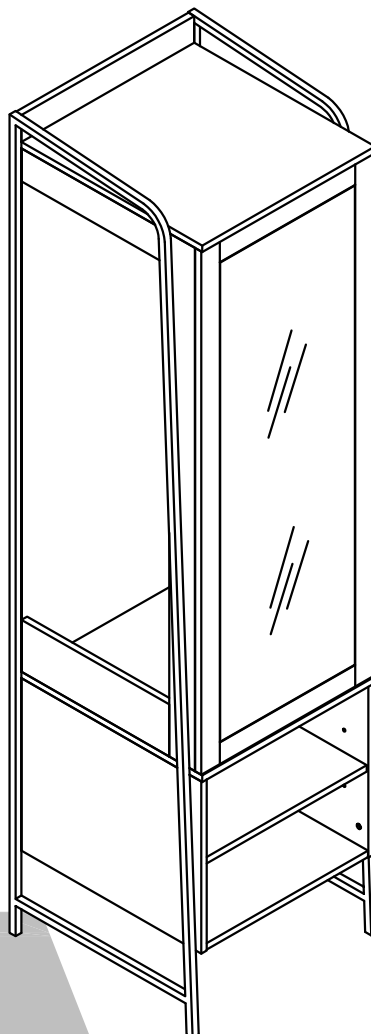

THIS INSTRUCTION BOOKLET CONTAINS **IMPORTANT** SAFETY INFORMATION. PLEASE READ AND KEEP FOR FUTURE REFERENCE.

Do Not Return This Product!

Contact our customer service team for help first.

Call: 1-800-489-3351 (toll free)

Monday-Friday 9am - 5pm CST

Visit: www.ameriwoodhome.com

WARNING

- Unit can tip over causing severe injury or death.
- Anchor unit to stud in wall (if instructed to).
- Do Not allow children to climb on unit.
- Put heavy items on lower shelves or drawers.



Follow Ameriwood Home



Contact Us!

Do NOT return this product!

Contact our friendly customer service team first for help.



Visit ameriwoodhome.com

Assembly Tips



Helpful Hints

PEOPLE NEEDED FOR ASSEMBLY: 2

ESTIMATED ASSEMBLY TIME: 1.5-2.0 HOUR

- Open your item in the area you plan to keep it to avoid excessive heavy lifting.
- Identify, sort and count the parts before attempting assembly.
- Compression dowels are lightly tapped in with a hammer.
- Slides are labeled with a R (right) and L (left) for proper placement.
- Make sure to always face the point on the top of the Cam Lock towards the outer edge.
- Use all the nails provided for the back panel and spread them out equally.
- Back panel must be used to make sure your unit is sturdy.
- Do NOT use harsh chemicals or abrasive cleaners on this item.
- Never push, pull, or drag your furniture.



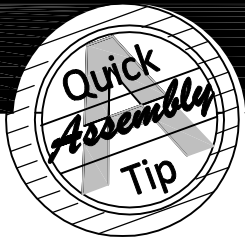

Before You Start

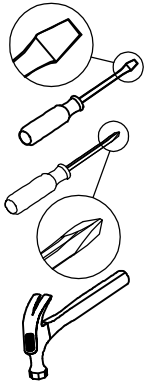

- ✓ Read through each step carefully and follow the proper order
- ✓ Separate and count all your parts and hardware
- ✓ Give yourself enough room for the assembly process
- ✓ Have the following tools: Flat Head Screwdriver, #2 Phillips Head Screwdriver and Hammer
- ✓ Caution: If using a power drill or power screwdriver for screwing, please be aware to slow down and stop when screw is tight. Failure to do so may result in stripping the screw.

Cam Lock Fastening System

This Cam Lock Fastening System will be used throughout the assembly process.

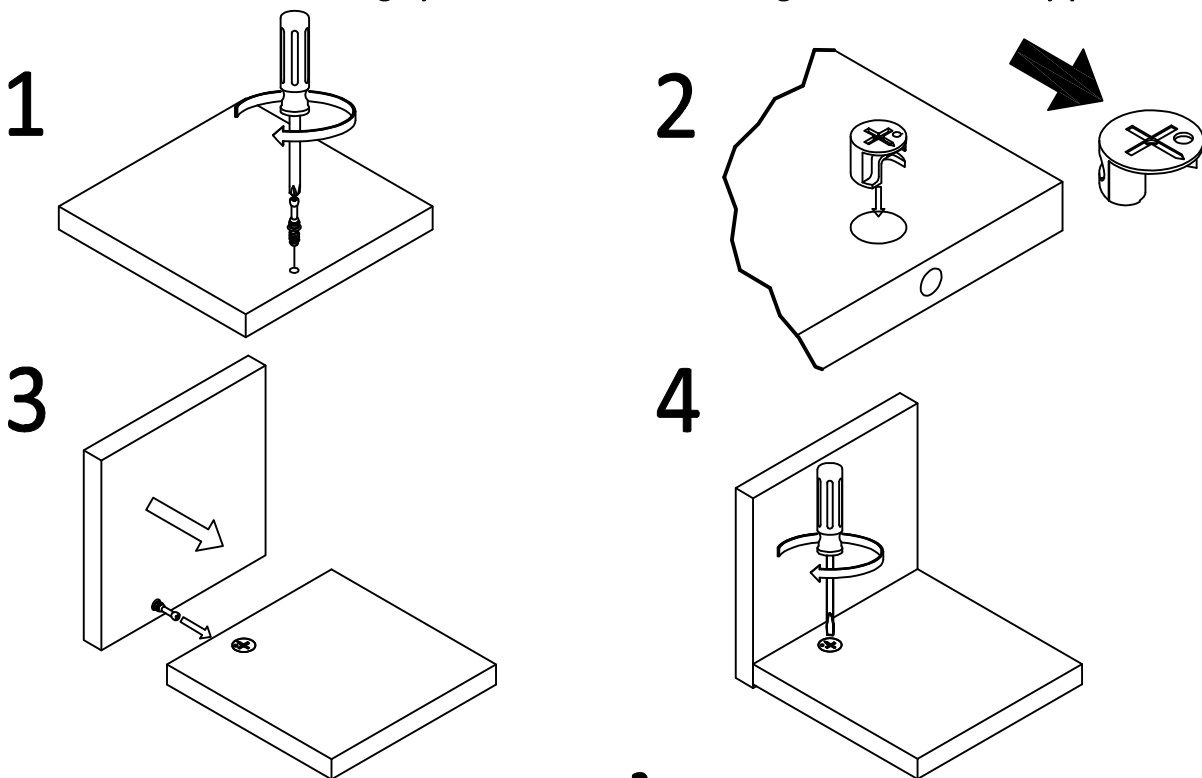

Board Identification

Not Actual Size

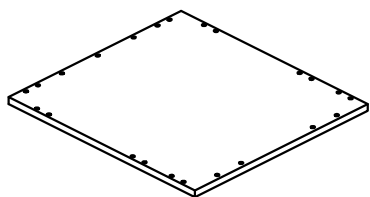

A
Top panel
T3941348010KX

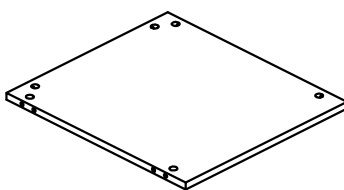

B
Bottom panel
T3941348020KX

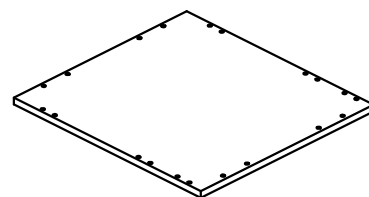

C
Middle shelf
T3941348030KX

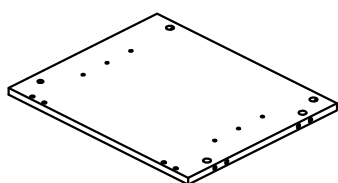

D
Lower left side panel
T3941348040KX

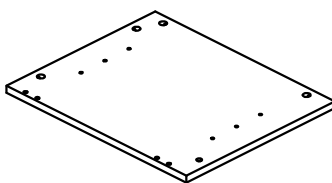

E
Lower right side panel
T3941348050KX

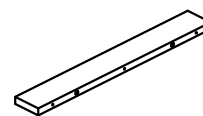

F
Upper rear rail
T3941348060KX

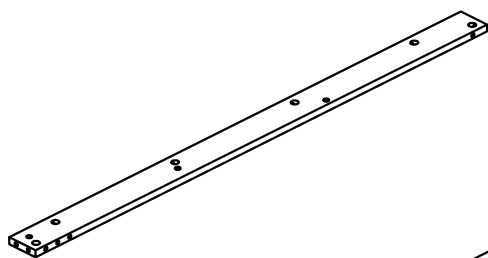

G
Upper left side rail
T3941348070KX

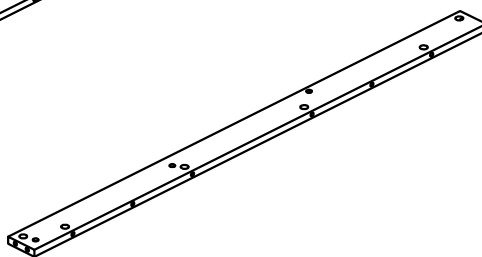

H
Upper right side rail
T3941348080KX

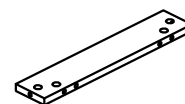

I
Upper rail
T3941348090KX
QTY:2PCS

Board Identification

Not Actual Size

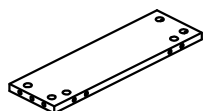

J

Lower rail
T3941348100KX
QTY:2PCS

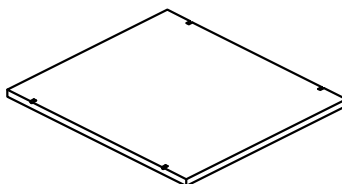

K

Adjustable shelf
T3941348110KX

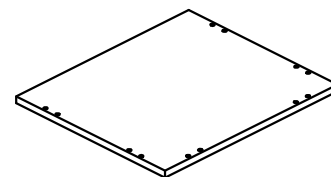

L

Lower back
T3941348120KX

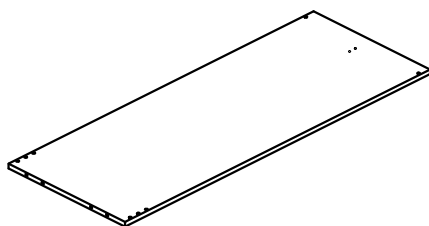

M

Upper back
T3941348130KX

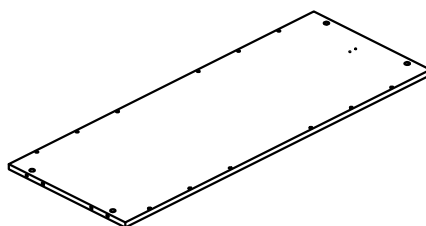

N

Mirror frame
T3941348140KX

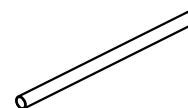

O

Clothes rod
T3941348150KX

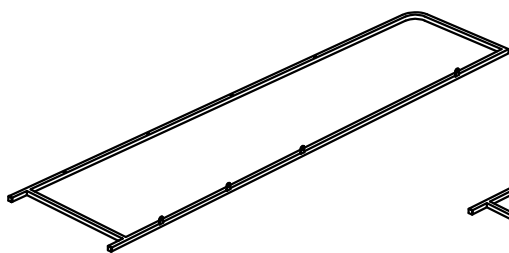

P

Left leg frame
T3941348160KX

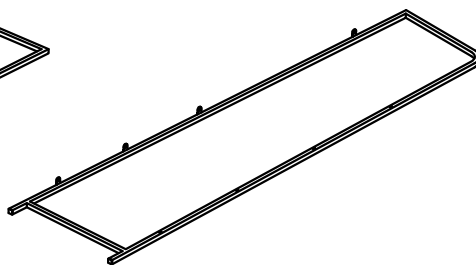

Q

Right leg frame
T3941348170KX

Preassembled parts	
Left leg frame	T3941348160KX1
Tube plug(2)	TKX1513

Preassembled parts	
Right leg frame	T3941348170KX1
Tube plug(2)	TKX1513

Board Identification

Not Actual Size

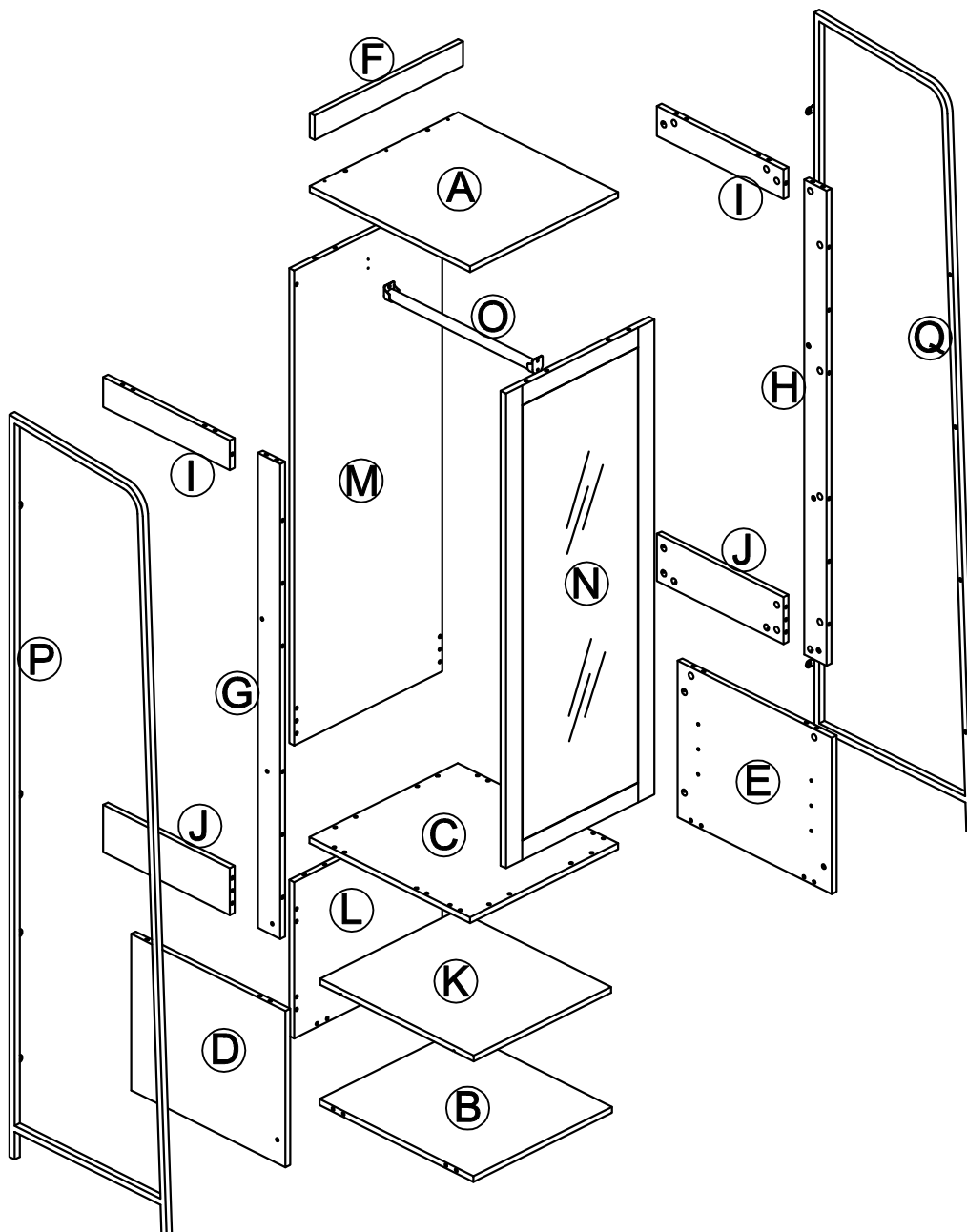

Part List

Actual Size

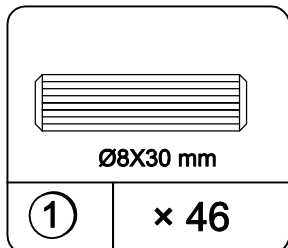

Wood dowel
TKX1005

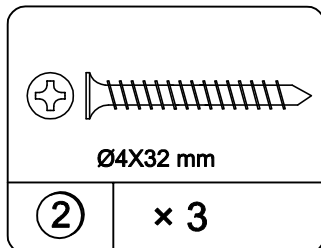

Screw
TKX1456

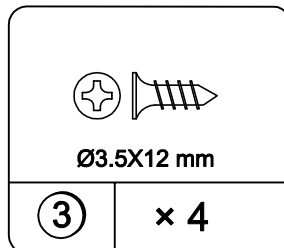

Screw
TKX1141

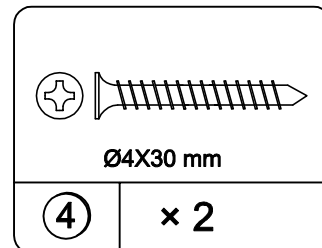

Screw
TKX1411

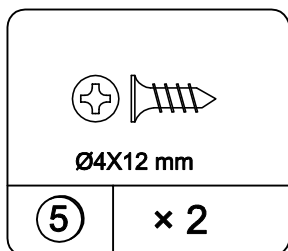

Screw
TKX1451

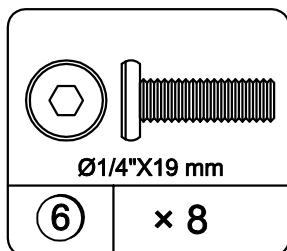

Bolt
TKX1516

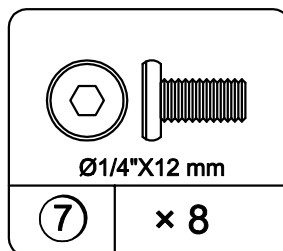

Bolt
TKX1033

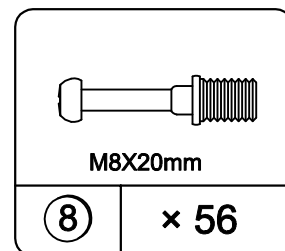

Cam bolt
TKX1191

Part List

Not Actual Size

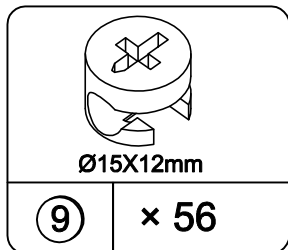

Cam lock
TKX1010

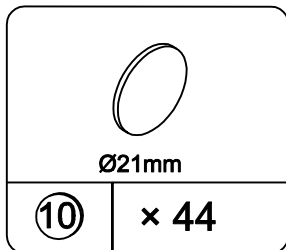

Cam cover
TKX1518

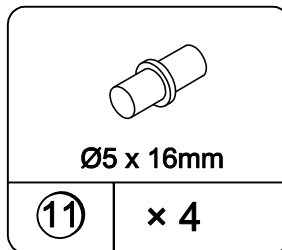

Shelf support
TKX1174

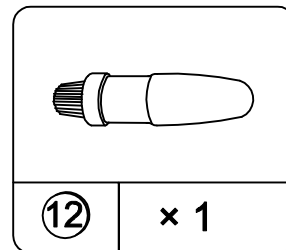

Glue
TKX1014

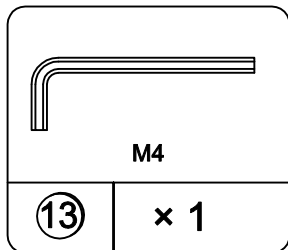

Hex key
TKX1004

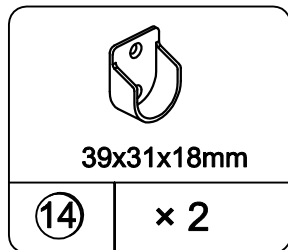

Clothes joe
TKX1519

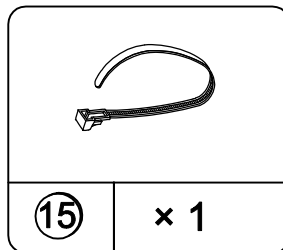

Strap
TKX1448

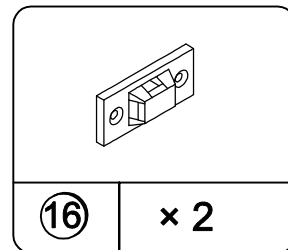

Clip
TKX1061

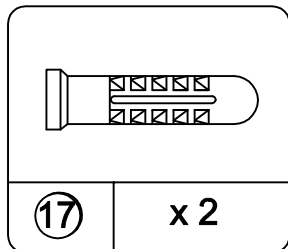

Wall anchor
TKX1042

STEP 1

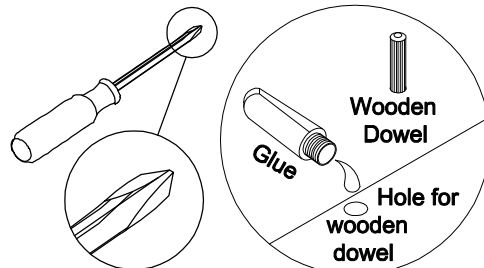
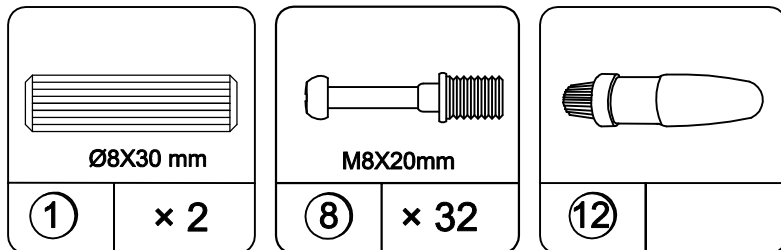

Use one drop of glue in dowel hole.

1.1 Attach (1) to (L) as illustrated.

1.2 Attach (8) to (A), (C) & (L) as illustrated.

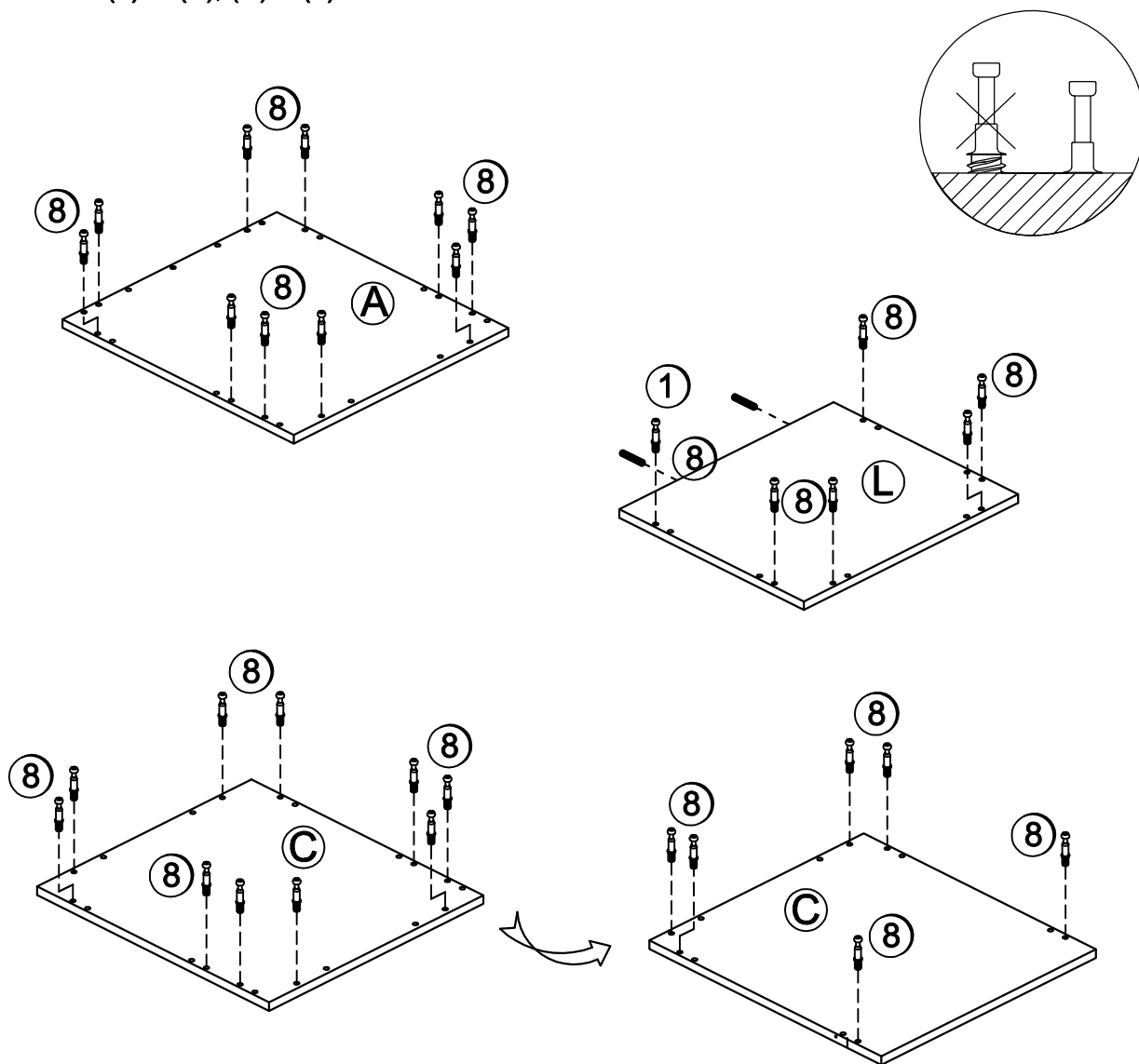

STEP 2

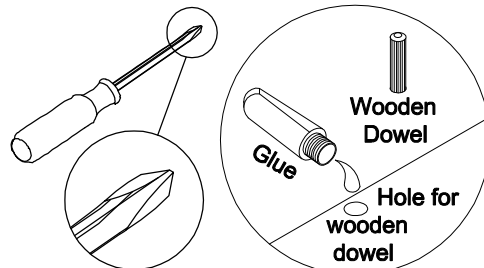
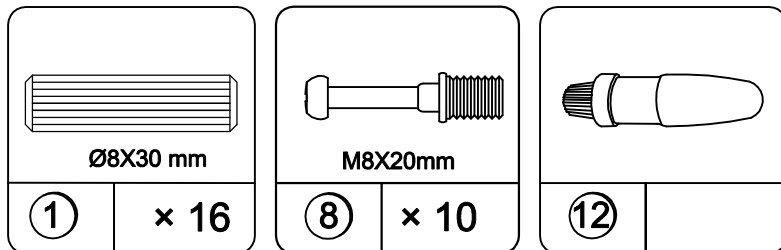

2.1 Attach (1) to (D), (E), (G) & (H) as illustrated.

2.2 Attach (8) to (D), (E), (G) & (H) as illustrated.

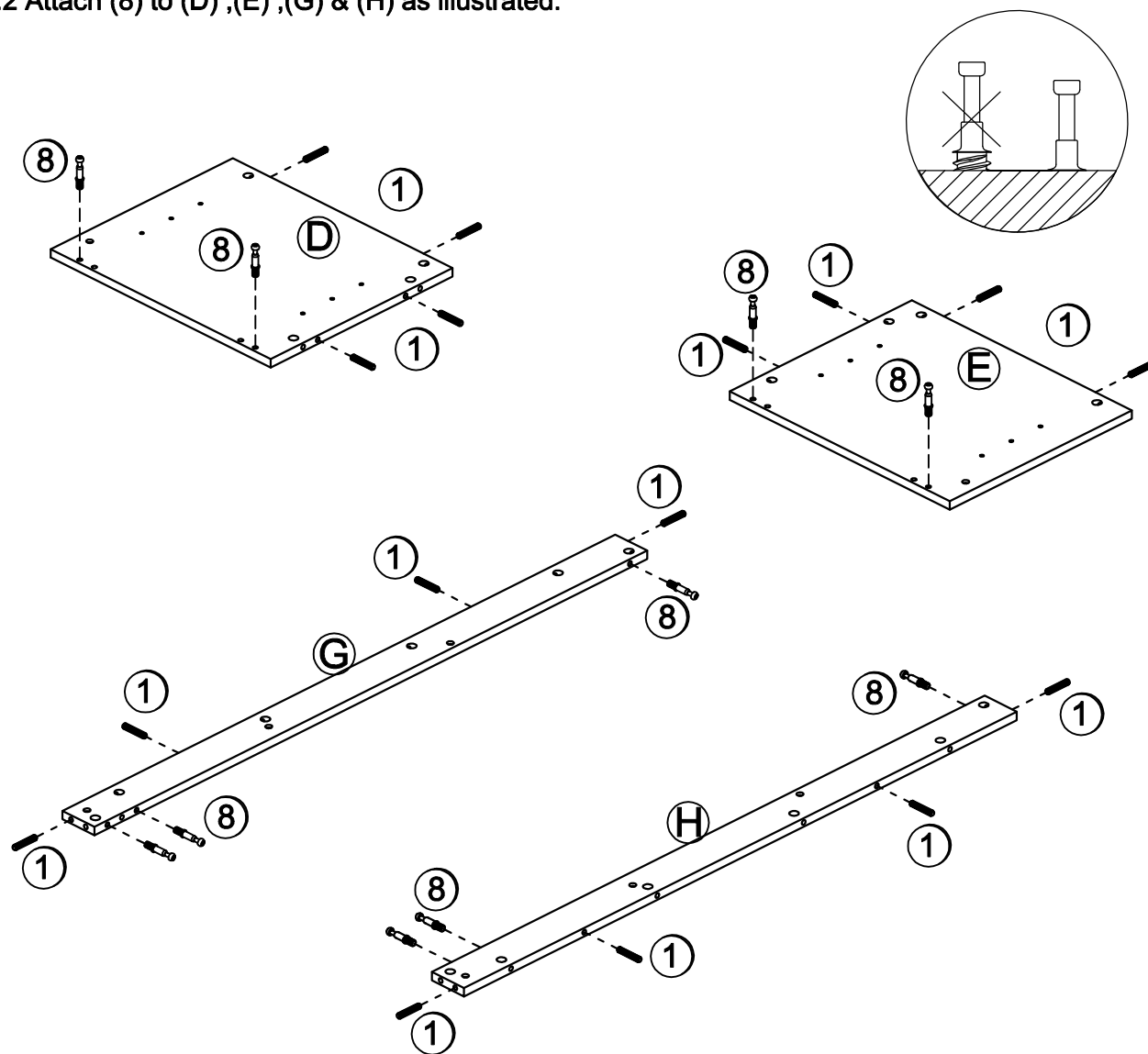

STEP 3

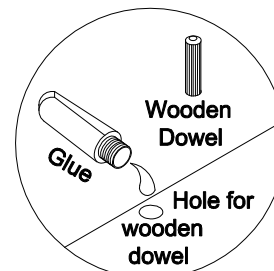
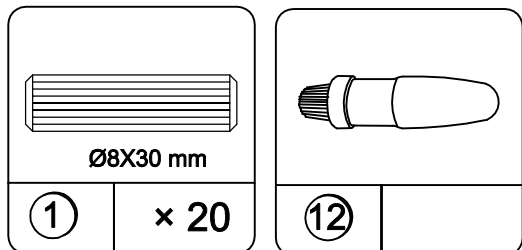

Use one drop of glue in dowel hole.

3.1 Attach (1) to (B) ,(F) ,(I) & (J) as illustrated.

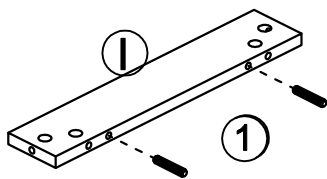
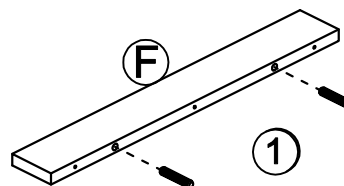
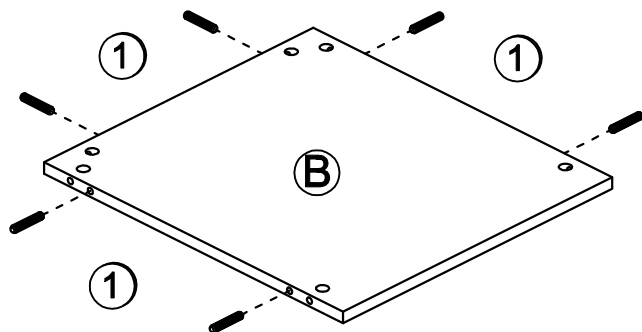

X2

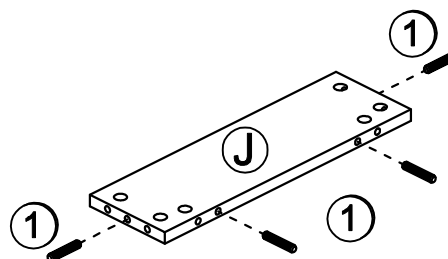

X2

STEP 4

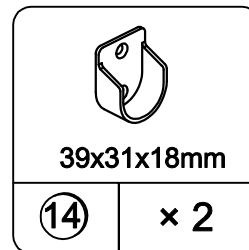
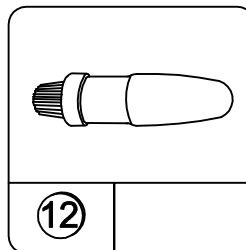
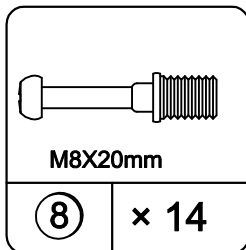
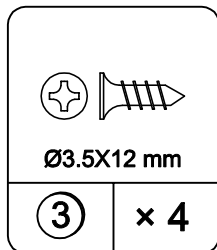
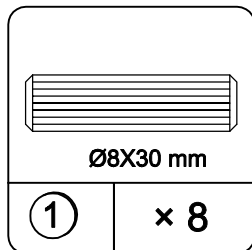

- 4.1 Attach (1) to (M) & (N) as illustrated.
- 4.2 Attach (8) to (M) & (N) as illustrated.
- 4.3 Attach (14) to (M) & (N) with (3) as illustrated.

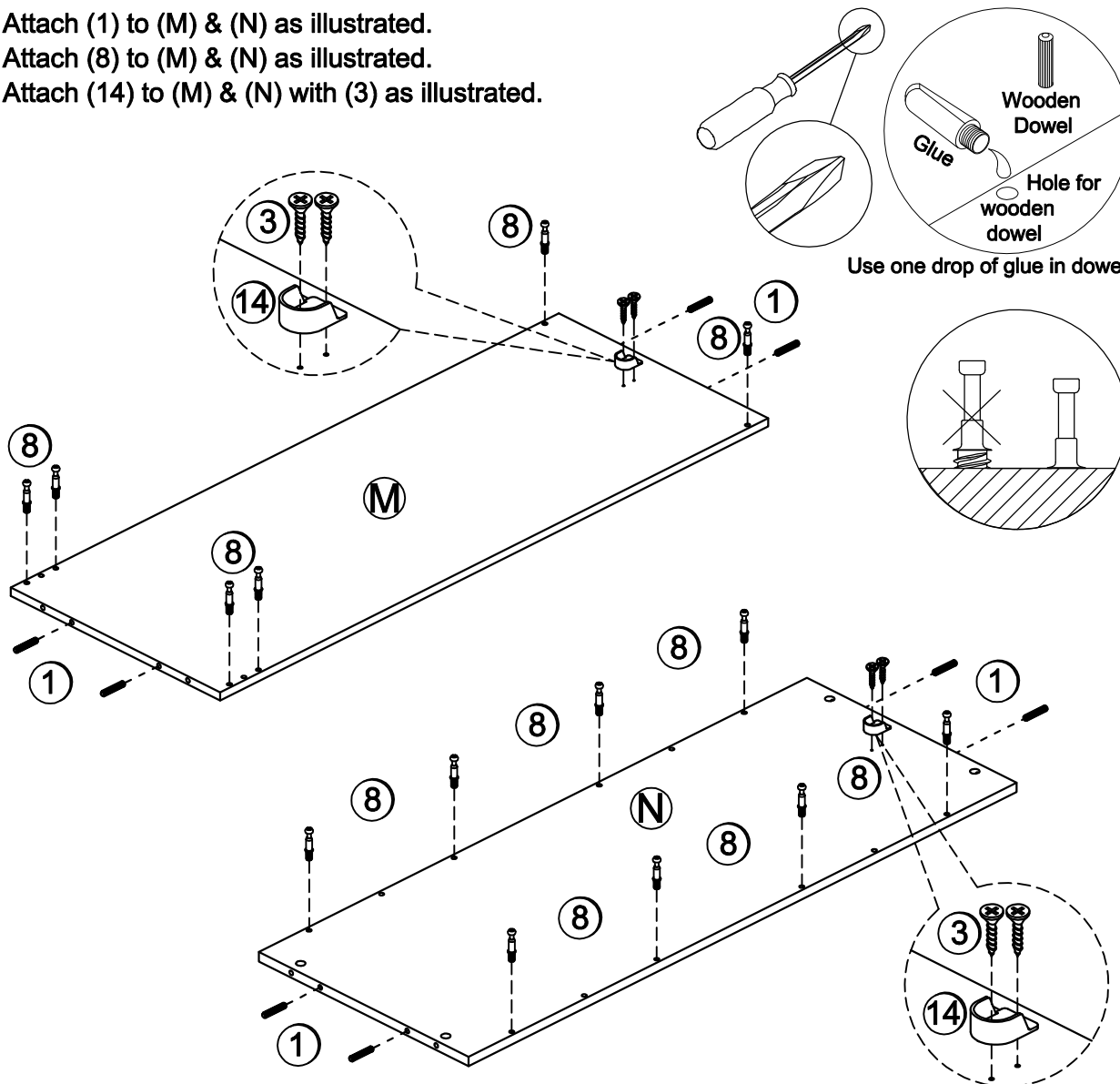

STEP 5

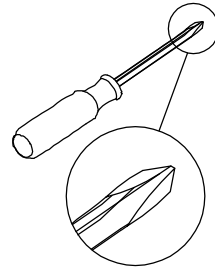
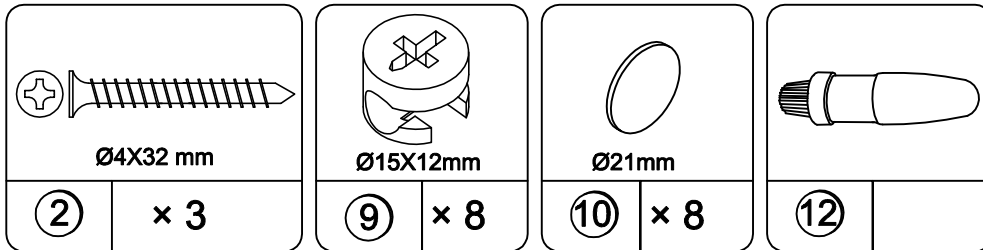

- 5.1 Attach (F) to (A) with (2) as illustrated.
- 5.2 Attach (G), (H) to (N) with (9) as illustrated.
- 5.3 Use (10) to cover cam lock holes as illustrated.

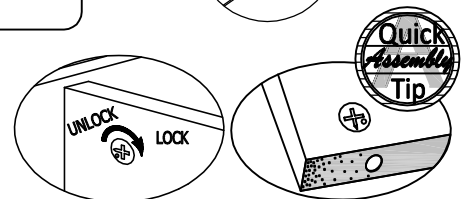

Proper orientation of CAM LOCK

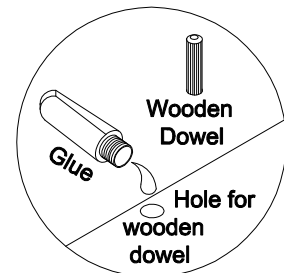

Use one drop of glue in dowel hole.

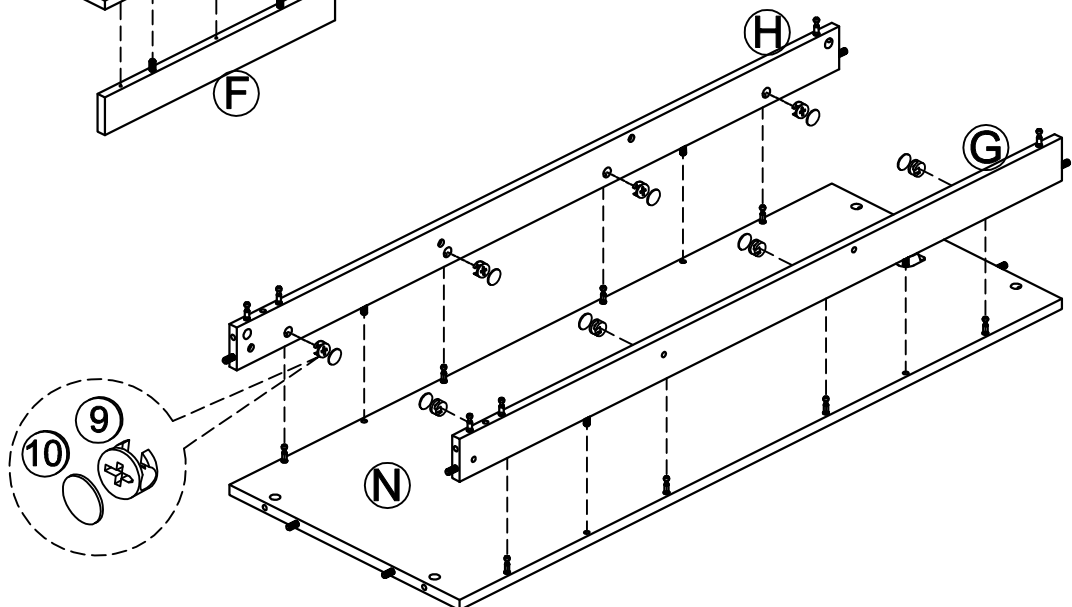
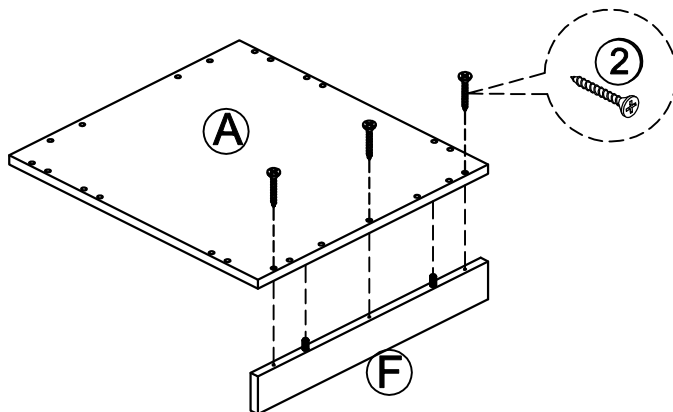

STEP 6

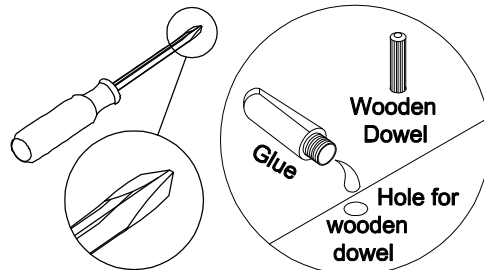
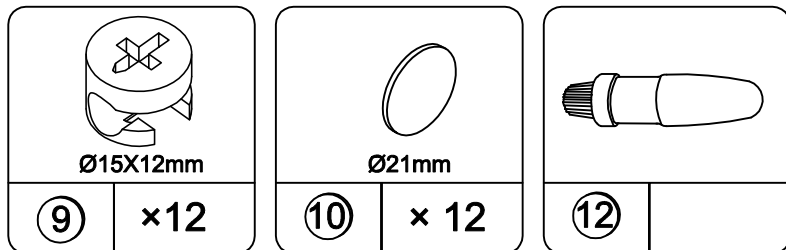

Use one drop of glue in dowel hole.

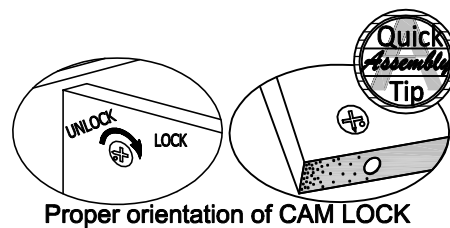

- 6.1 Attach (I), (J) to (G), (H) & (M) with (9) as illustrated.
- 6.2 Use (10) to cover cam lock holes as illustrated.

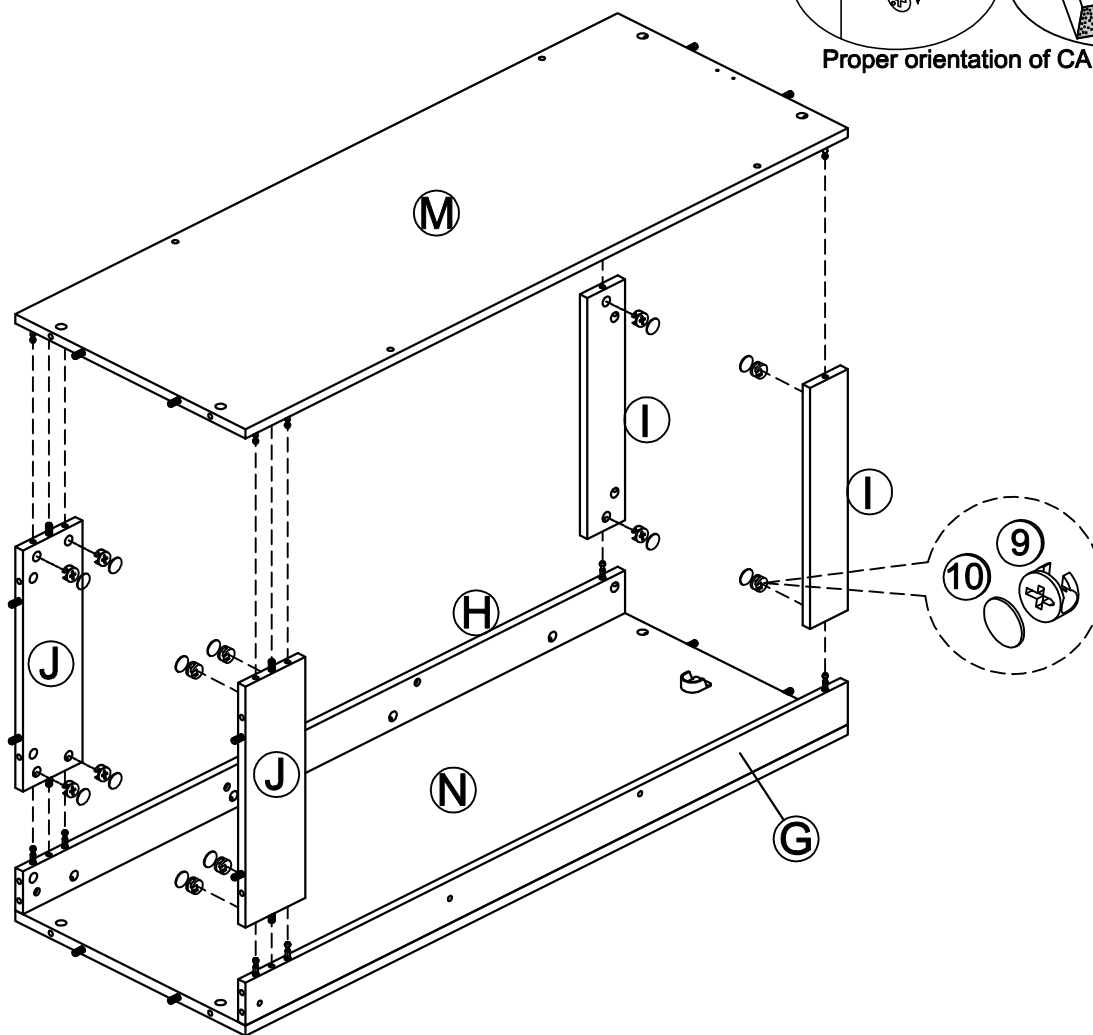

STEP 7

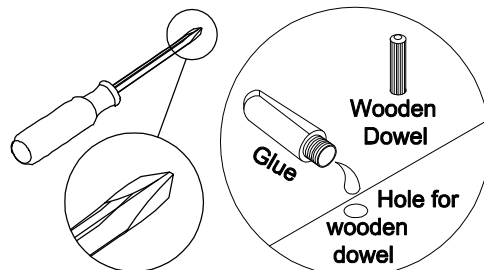
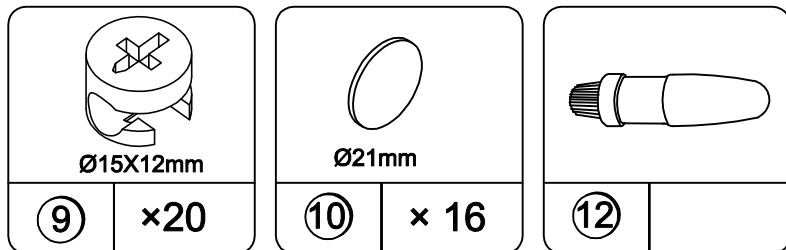

7.1 Attach (A), (C) to sample from previous step with (9) as illustrated.

Use one drop of glue in dowel hole.

7.2 Use (10) to cover cam lock holes as illustrated.

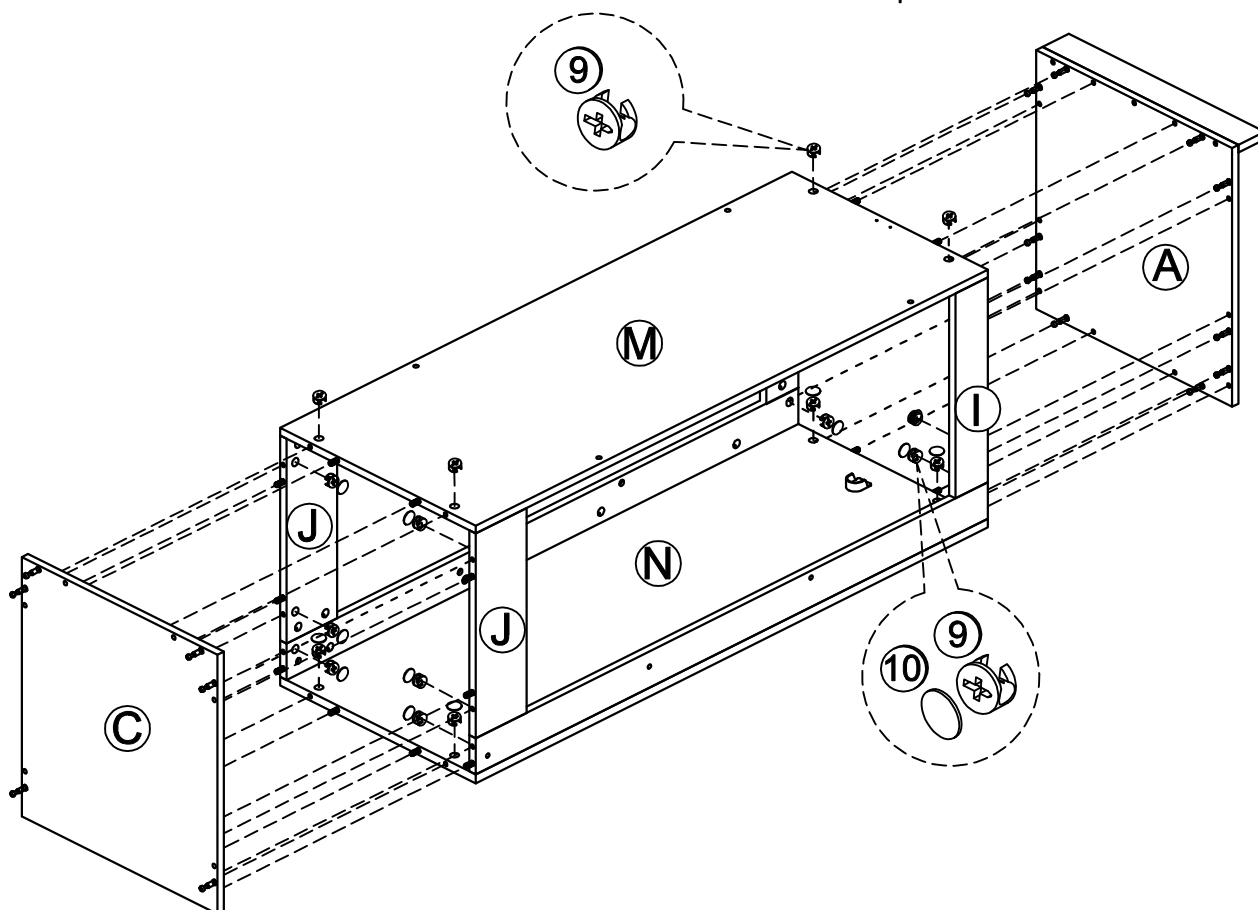
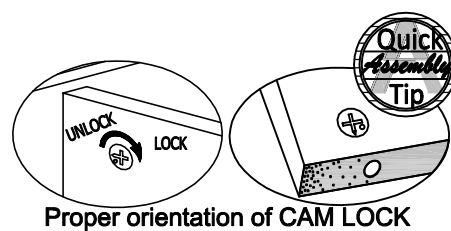

STEP 8

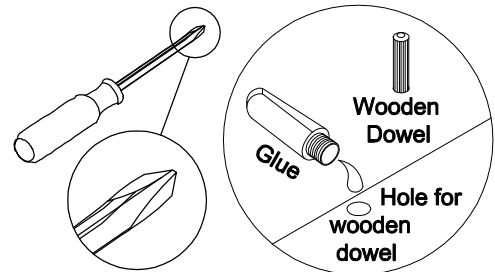
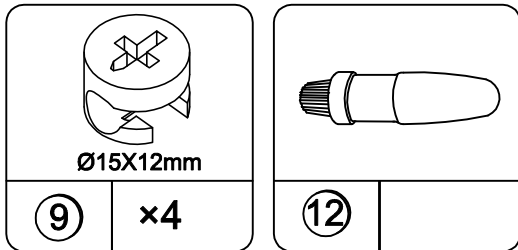

Use one drop of glue in dowel hole.

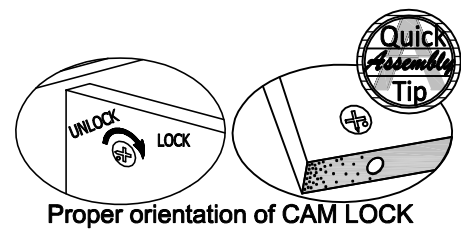

Proper orientation of CAM LOCK

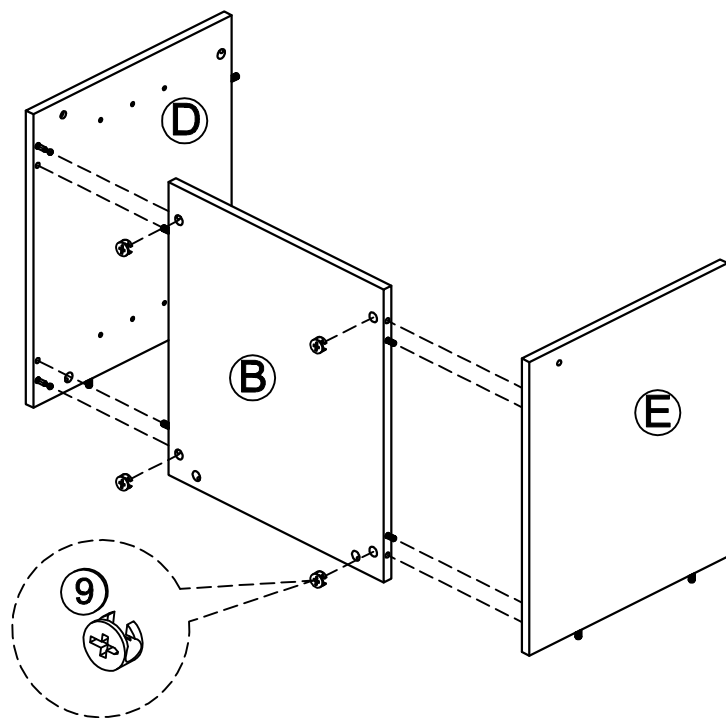

STEP 9

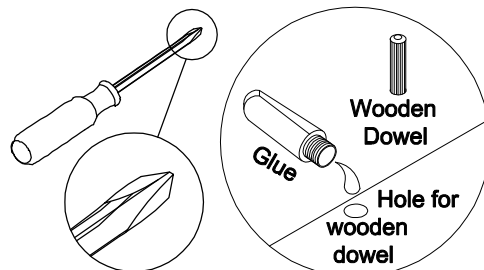
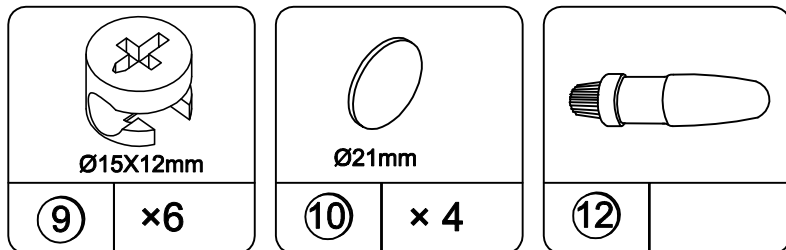

Use one drop of glue in dowel hole.

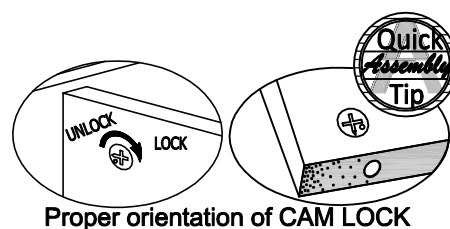

Proper orientation of CAM LOCK

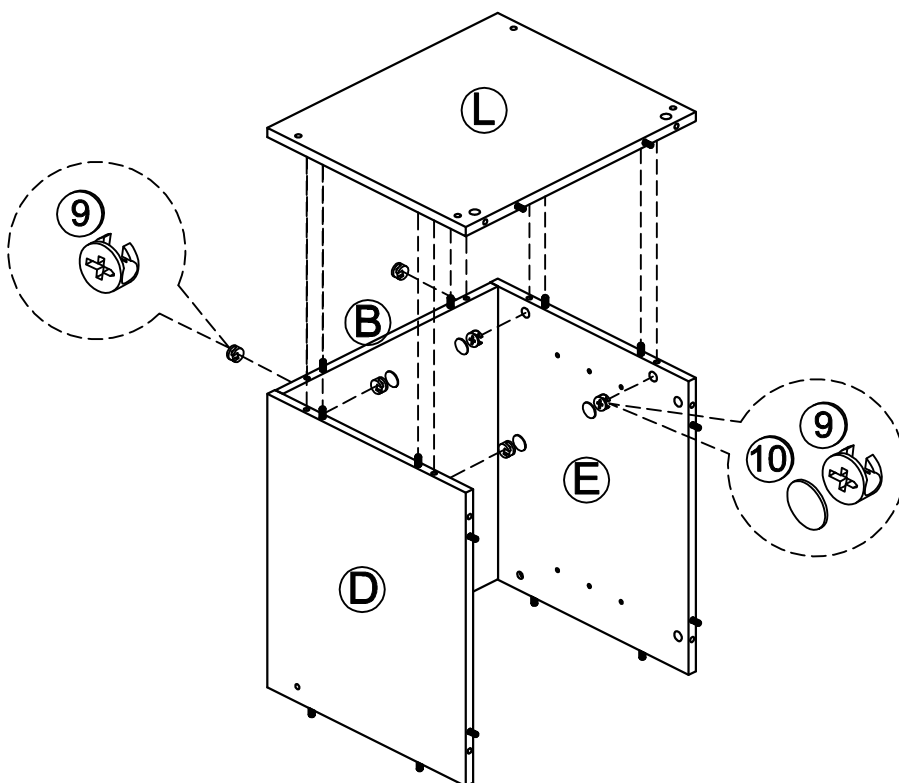

STEP 10

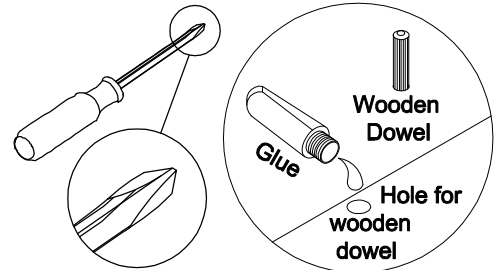
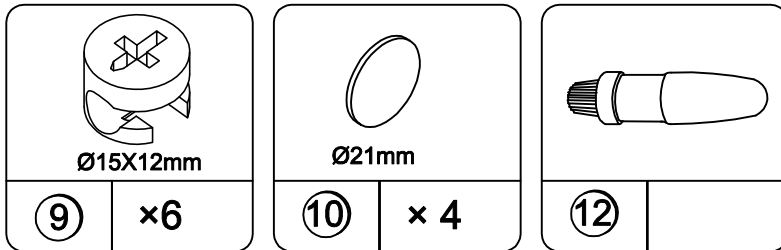

Use one drop of glue in dowel hole.

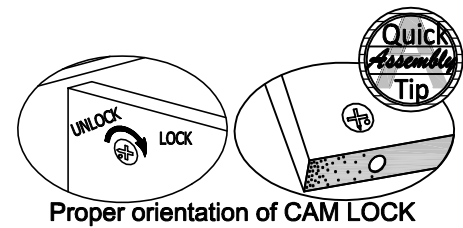

Proper orientation of CAM LOCK

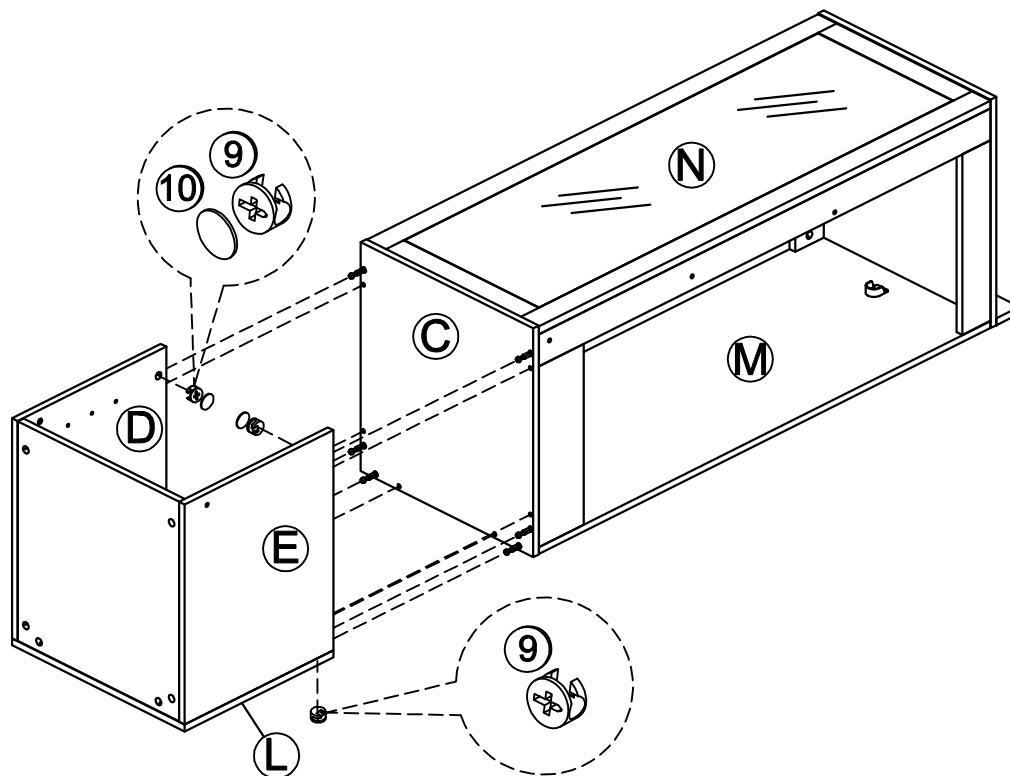

STEP 11

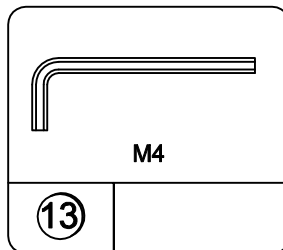
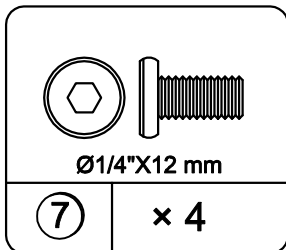
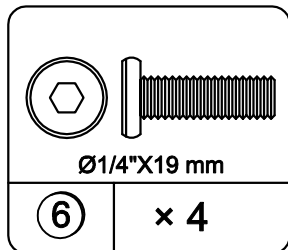

11.1 Attach (Q) to (E) & (H) with (6) as illustrated.

11.2 Attach (Q) to (L) & (M) with (7) as illustrated.

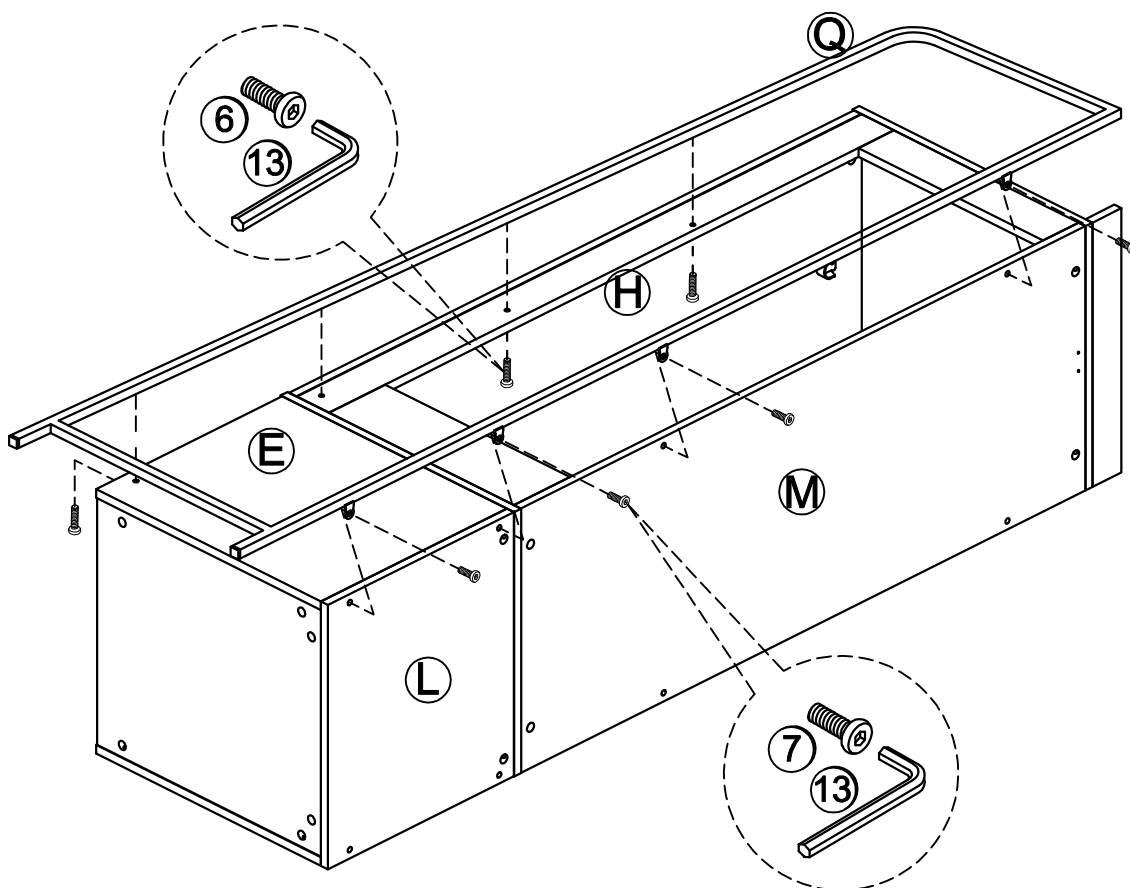

STEP 12

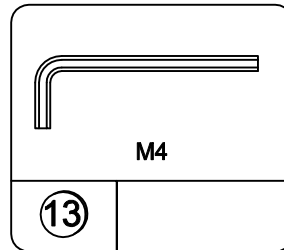
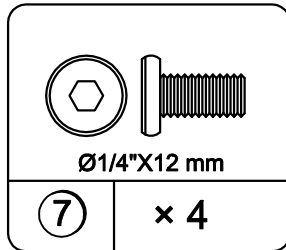
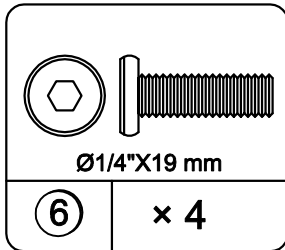

- 12.1 Attach (P) to (D) & (G) with (6) as illustrated.
- 12.2 Attach (P) to (L) & (M) with (7) as illustrated.

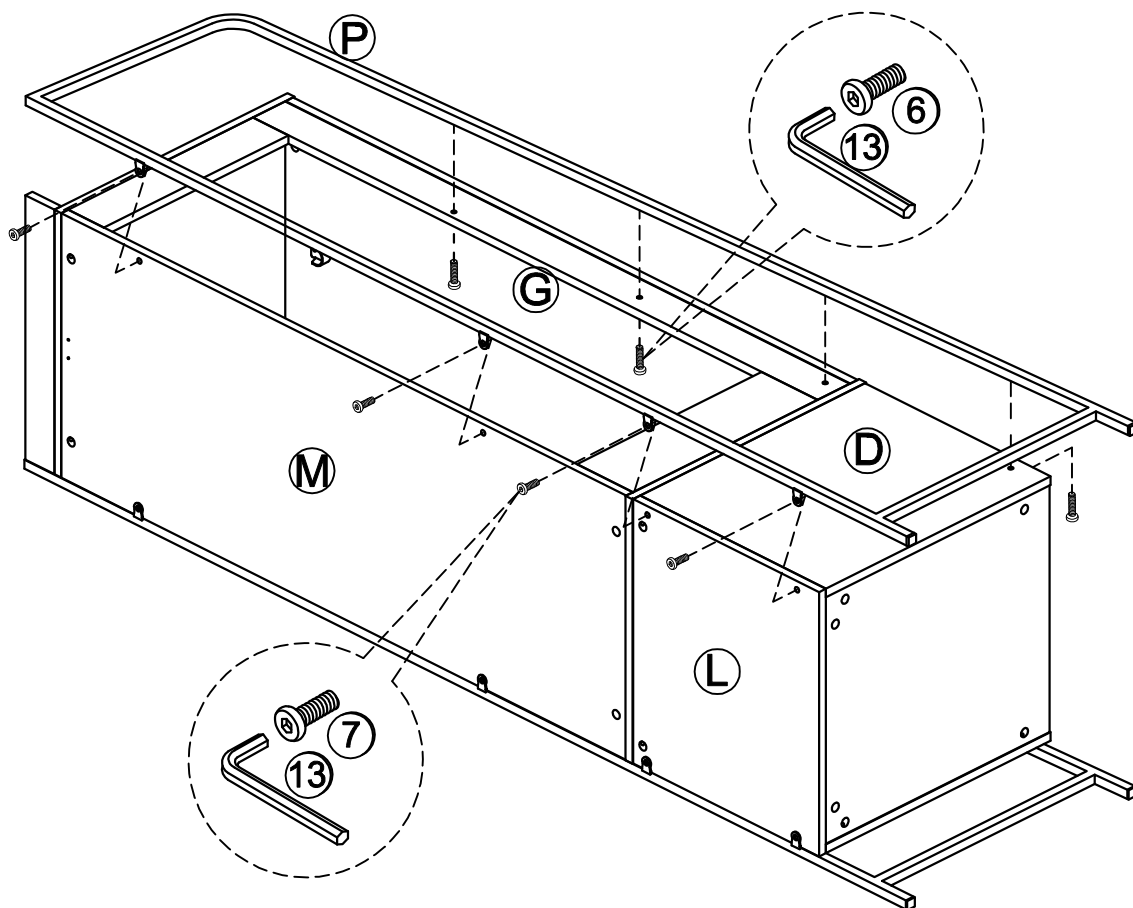

STEP 13

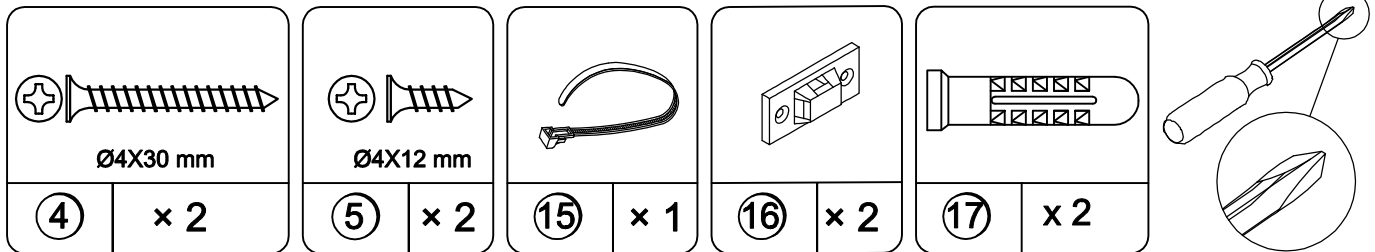

PLEASE NOTE THAT THIS UNIT MUST BE PLACED AGAINST A WALL.

Drill a 5 mm diameter hole(3/16") in the wallboard. tap the wall anchor (17) into the hole until it is flush. Using screw (4) to attach the wall bracket (16) to the wallboard. using screw(5) to attach the wall bracket (16) to the top shelf back. Move the furniture to its final position. Thread the strap (15) through the bracket (16) as shown in the illustration, tighten strap (15) until snug. Do NOT over tighten.

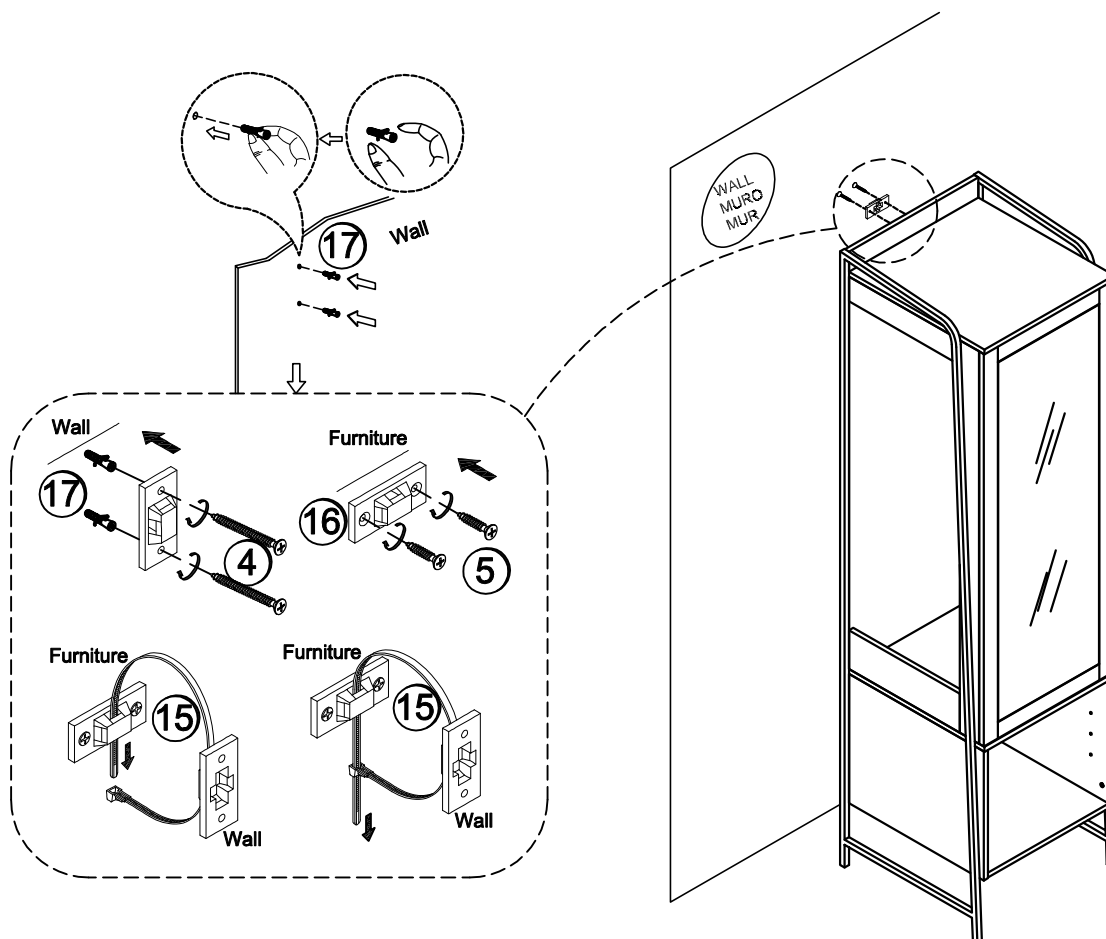

STEP 14

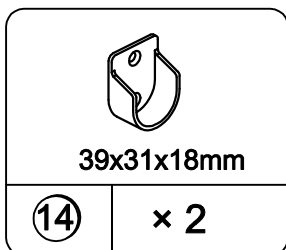
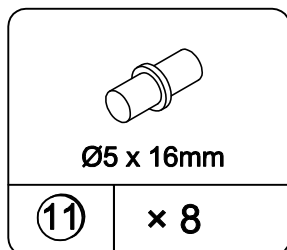

14.1 Insert (11) to (D) & (E) as illustrated.

14.2 Insert and put (K) on (11) as illustrated.

14.3 Insert and put (O) on (14) as illustrated.

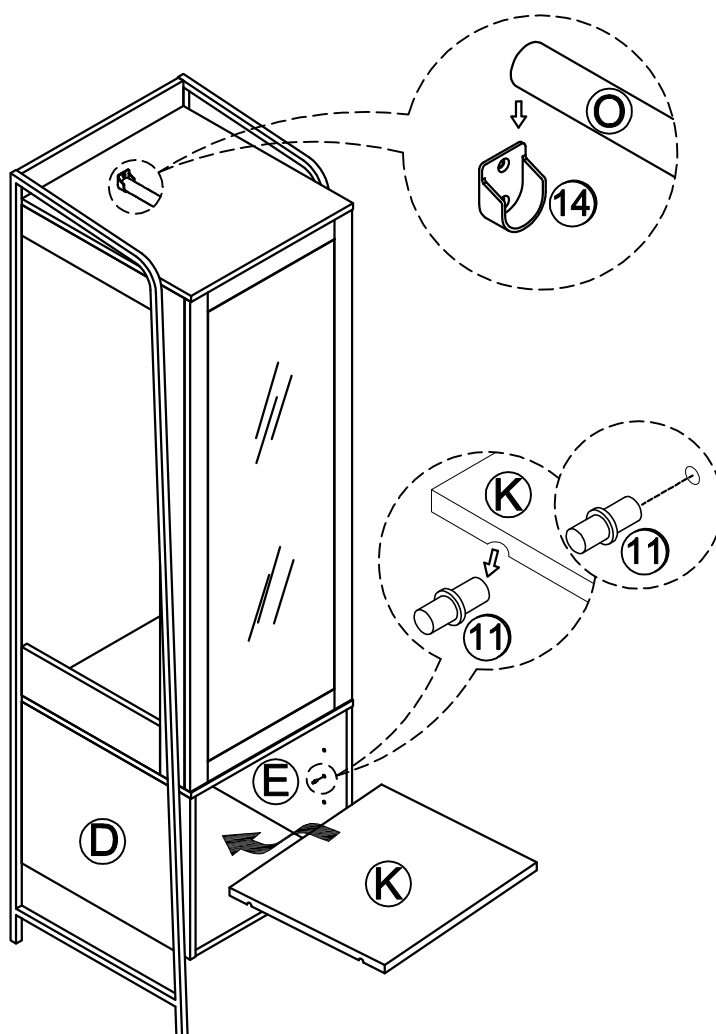

Maximum Loads

This unit has been designed to support the maximum loads shown. Exceeding these load limits could cause sagging, instability, product collapse, and/or serious injury.

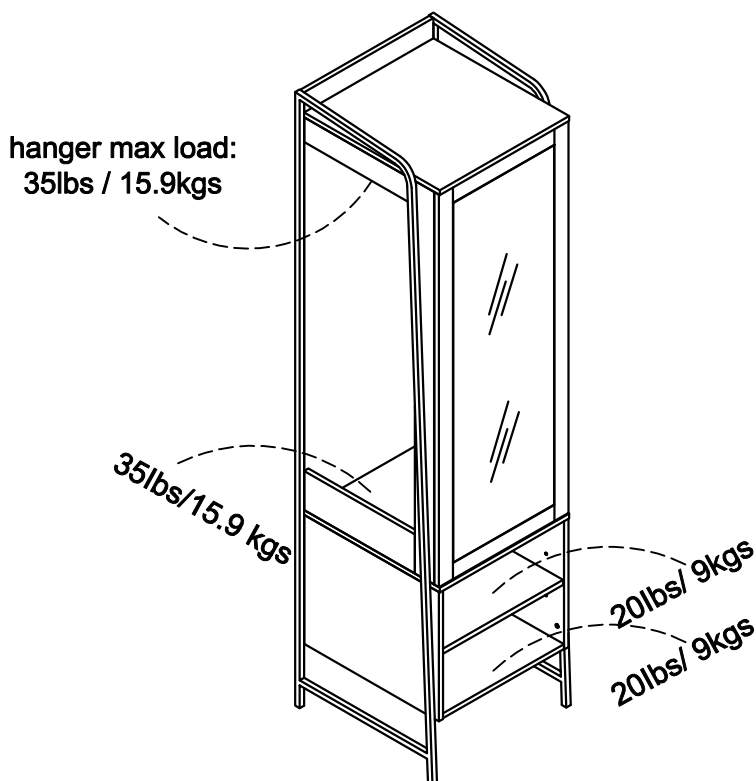

Warning: Risk of injury to persons - do not place a television on this furniture. This furniture is not approved for use with a television.

Certificate of Conformity

1. This certificate applies to the Dorel Home Furnishings, Inc. product identified by this instruction manual.
2. This certificate applies to compliance of this product with the CPSC Ban on Lead-Containing Paint (16 CFR 1303).
3. This product is distributed by: Dorel Home Furnishings, Inc.
410 East First Street South
Wright City, MO 63390
636-745-3351
4. Site of Manufacture: Svay Rieng, Cambodia
5. See front page of instruction manual for date of manufacture.

Register your product to receive the following:



- * **New trend details - sneak peek on what's new**
- * **Surveys - have a voice within our community**
- * **Exclusive deals and discount codes**
- * **Quick and easy replacement part service**

To register your product, visit ameriwoodhome.com

Star Rating



Visit your local retailer's website, rate your purchased product and leave us some feedback!

We would like to extend a big "Thank You" to all of our customers for taking the time to assemble this Ameriwood Home product, and to give us your valuable feedback.

*Thank
You!*

Español

Cubierta Delantera

Este libro de instrucciones contiene información **IMPORTANTE** de seguridad. Por favor lea y manténgalo para referencia en el futuro.

No Regrese este producto! Comuníquese con nuestro amigoso equipo de servicio al cliente para obtener ayuda.

Llámenos al: 1-800-489-3351 (Gratis) Lunes - Viernes 9am - 5pm CST

Visitar: www.ameriwoodhome.com

PRECAUCION

Este mueble puede volcarse y causar graves heridas y/o muerte.

Anclar el mueble a un poste de madera en la pared (si esto se requiere).

No Permita que los niños monten el mueble.

Mantenga los artículos más pesados en los cajones de abajo.

Consejos Útiles (página 2)

- Abra su artículo en el área donde usted planea utilizarlo para evitar levantar y moverlo menos
- Identificar, ordenar y contar las piezas antes de intentar ensamblar
- Las clavijas de compresión se golpean con un martillo
- Las diapositivas están marcadas con una R (derecha) y L (izquierda) para la colocación correcta
- Asegúrese de que siempre este el punto localizado en la parte superior de bloqueador de leva este volteado hacia borde exterior
- Utilizar todos los clavos para el panel de atrás y distribuirlos por igual
- El panel de atrás debe utilizarse para asegurarse de que la unidad quede fija y firme
- No use químicas fuertes ni limpiadores abrasivos en este artículo
- Nunca empuje, tire ni arrastre los muebles

Antes de Que Empieces (página 3)

- Lea cuidadosamente cada paso y siga el orden correcto

- Separar y contar todas sus piezas y hardware

- Dése suficiente espacio para el proceso de ensamble

- Tenga las siguientes herramientas: destornillador de cabeza plana, #2 cabeza Phillips

Destornillador y martillo

- Precaución: Si usa un taladro electrónico o un destornillador eléctrico para atornillar, por favor asegúrese que deje de atornillar cuando el tornillo este apretado. Fallar hacer esto puede causar barrer el tornillo.

Sistema de fijar el bloqueo de leva (página 3)

Este sistema de fijar el bloqueo de leva sera usado en todo el proceso ensamble.

Español

Identificación de los Paneles (Página 4-6)

Este no es el tamaño real

- (A) PANEL SUPERIOR
- (B) PANEL INFERIOR
- (C) ESTANTE MEDIO
- (D) PANEL LATERAL INFERIOR IZQUIERDO
- (E) PANEL LATERAL INFERIOR DERECHO
- (F) RIEL TRASERO SUPERIOR
- (G) RIEL LATERAL IZQUIERDO SUPERIOR
- (H) BARANDILLA LATERAL SUPERIOR DERECHA

- (I) CARRIL SUPERIOR
- (J) RIEL INFERIOR
- (K) ESTANTE AJUSTABLE
- (L) ESPALDA SUPERIOR
- (M) PARTE INFERIOR DE LA ESPALDA
- (N) MARCO DEL ESPEJO
- (O) BARRA DE ROPA
- (P) ESTRUCTURA DE LA PATA IZQUIERDA
- (Q) ESTRUCTURA DE LA PATA DERECHA

Lista de Piezas (Página 7)

Tamaño real

- (1) Taco de madera
- (2) Tornillo
- (3) Tornillo
- (4) Tornillo
- (5) Tornillo
- (6) Perno
- (7) Perno
- (8) Perno de leva

Lista de Piezas (Página 8)

Este no es el tamaño real

- (9) Bloqueo de leva
- (10) Cubierta de leva
- (11) Soporte de estante
- (12) Pegamento
- (13) Llave hexagonal
- (14) Ropa joe
- (15) Correa
- (16) Clip
- (17) Anclaje de pared

Página 9

- 1.1 Fije (1) a (L) como se ilustra.
- 1.2 Fije (8) a (A), (C) y (L) como se ilustra.

Página 10

- 2.1 Fije (1) a (D), (E), (G) y (H) como se ilustra.
- 2.2 Fije (8) a (D), (E), (G) y (H) como se ilustra.

Página 11

- 3.1 Fije (1) a (B), (F), (I) y (J) como se ilustra.

Página 12

- 4.1 Conecte (1) a (M) y (N) como se ilustra.
- 4.2 Fije (8) a (M) y (N) como se ilustra.
- 4.3 Fije (14) a (M) y (N) con (3) como se ilustra.

Página 13

- 5.1 Fije (F) a (A) con (2) como se ilustra.
- 5.2 Fije (G), (H) a (N) con (9) como se ilustra.
- 5.3 Use (10) para cubrir los orificios de bloqueo de leva como se ilustra.

Español

Página 14

6.1 Fije (I), (J) a (G), (H) y (M) con (9) como se ilustra.

6.2 Use (10) para cubrir los orificios de bloqueo de leva como se ilustra.

Página 15

7.1 Adjunte (A), (C) a la muestra del paso anterior con (9) como se ilustra.

7.2 Use (10) para cubrir los orificios de bloqueo de leva como se ilustra.

Página 16

8.1 Fije (D), (E) a (B) con (9) como se ilustra.

Página 17

9.1 Fije (L) a (B), (D) y (E) con (9) como se ilustra.

9.2 Use (10) para cubrir los orificios de bloqueo de leva como se ilustra.

Página 18

10.1 Fije (D), (E) y (L) a (C) con (9) como se ilustra.

10.2 Use (10) para cubrir los orificios de bloqueo de leva como se ilustra.

Página 19

11.1 Fije (Q) a (E) y (H) con (6) como se ilustra.

11.2 Fije (Q) a (L) y (M) con (7) como se ilustra.

Página 20

12.1 Fije (P) a (D) y (G) con (6) como se ilustra.

12.2 Fije (P) a (L) y (M) con (7) como se ilustra.

Página 21

TENGA EN CUENTA QUE ESTA UNIDAD DEBE COLOCARSE CONTRA UNA PARED.

Taladre un orificio de 5 mm de diámetro (3/16") en el panel de yeso. Golpee el anclaje de pared (17) en el orificio hasta que quede al ras. Con el tornillo (4)

para fijar el soporte de pared (16) al wallbord. usando un tornillo para sujetar el panel de yeso. Usando el tornillo (5) para sujetar el soporte de pared (16) a la parte posterior del estante superior. Mueva los muebles a su posición final. Pase la correa (15) a través del soporte (16) como se muestra en la ilustración, apriete la correa (15) hasta que quede ajustada. NO apriete demasiado.

Página 22

14.1 Inserte (11) en (D) y (E) como se ilustra.

14.2 Inserte y coloque (K) en (11) como se ilustra.

14.3 Inserte y coloque (O) en (14) como se ilustra.

Página 23

CARGA MAXIMA

Esta unidad ha sido diseñada para soportar la carga máxima anotada. El exceder estos límites puede causar inestabilidad, colapsarse y/o causar serias lesiones.

ADVERTENCIA: Riesgo de lesiones a las personas - no coloque un televisor sobre muebles. Este mueble no está aprobado para su uso con un televisor.

Página 24

Registre su producto para recibir lo siguiente:

- * Detalles de nuevas tendencias - Vistazo a lo nuevo
- * Encuestas - alec su voz entre su comunidad
- * Códigos de ofertas y descuentos exclusivos
- * Fácil y rápido servicio de partes de remplazce

Para registrar su producto, visite ameriwoodhome.com

Clasificación de 5 estrellas

Visite el sitio web de su distribuidor local, califique el producto que compró y déjenos sus comentarios.

Nos gustaría enviar un gran "Agradecimiento" a todos nuestros clientes por tomarse el tiempo de ensamblar este producto de Ameriwood Home, y por darnos sus valiosos comentarios.

Gracias

Français

Couverture Avant

CE LIVRET D'INSTRUCTION CONTIENT DES INFORMATIONS **IMPORTANTES** SUR LA SÉCURITÉ.
VEUILLEZ LIRE ET GARDER POUR UNE RÉFÉRENCE FUTURE

Ne retournez pas ce produit! Contactez notre équipe de service à la clientèle amicale d'abord pour obtenir de l'aide.

Appelez-nous: 1-800-489-3351 (sans frais) du Lundi au Vendredi de 9h à 17h Heure Centrale

Visitez: www.ameriwoodhome.com

ATTENTION

Le meuble peut basculer et causer des blessures graves ou la mort.

Ancrer le meuble à une planche murale dans le mur (si indiqué).

Ne laissez pas les enfants grimper sur le meuble.

Placez les articles lourds sur les étagères ou dans les tiroirs inférieurs.

Astuces Utiles (page 2)

-Ouvrez votre article dans la zone que vous prévoyez de le garder pour moins de levage lourd

-Identifier, trier et compter les pièces avant d'essayer d'assembler

-Les goujons de compression sont taraudés avec un Marteau

-Les glissières sont marquées d'un R (droit) et d'un L (gauche) pour un bon placement

-Assurez-vous toujours de faire face la pointe situé sur le haut de la Serrure de Came vers le bord extérieur

-Utiliser tous les clous fournis pour le panneau arrière et les répartir également

-Le panneau arrière doit être utilisé pour vous assurer que votre appareil est robuste

-N'utilisez pas de produits chimiques agressifs ou de nettoyeurs abrasifs sur cet appareil

-Ne jamais pousser, tirer, ou faire glisser votre meuble

Avant de Commencer (page 3)

-Lisez attentivement chaque étape et suivez le bon ordre

-Séparez et comptez toutes vos pièces et matériaux

-Donnez-vous suffisamment de place pour l'assemblage

-Avoir les outils suivants: tournevis à tête plate, #2 tournevis Phillips, et Marteau

-Attention: Si vous utilisez une perceuse électrique ou un tournevis électrique pour visser, veillez à ralentir et arrêter lorsque la vis est bien serrée. Le non-respect de cette consigne peut endommager la vis.

Système de Fixation de Came (page 3)

Ce Système de Fixation de Came sera utilisé tout au long de l'assemblage

Français

Identification des matériaux (Page 4-6)

Pas de taille réelle

- | | |
|--------------------------------------|-------------------------------|
| (A) PANNEAU SUPÉRIEUR | (H) RAIL CÔTÉ SUPÉRIEUR DROIT |
| (B) PANNEAU INFÉRIEUR | (I) RAIL SUPÉRIEUR |
| (C) TABLETTE DU MILIEU | (J) RAIL INFÉRIEUR |
| (D) PANNEAU LATERAL INFÉRIEUR GAUCHE | (K) ÉTAGÈRE RÉGLABLE |
| (E) PANNEAU LATÉRAL INFÉRIEUR DROIT | (L) HAUT DU DOS |
| (F) RAIL ARRIÈRE SUPÉRIEUR | (M) BAS DU DOS |
| (G) RAIL LATÉRALE SUPÉRIEUR GAUCHE | (N) CADRE DE MIROIR |
| | (O) TRINGLE À VÊTEMENTS |
| | (P) CADRE DE PIED GAUCHE |
| | (Q) CADRE DE PIED DROIT |

Liste des pièces (Page 7)

Taille réelle

- (1) Cheville en bois
- (2) Vis
- (3) Vis
- (4) Vis
- (5) Vis
- (6) Boulon
- (7) Boulon
- (8) Boulon à came

Liste des pièces (Page 8)

Pas de taille réelle

- (9) Serrure à came
- (10) Couvercle de came
- (11) Support d'étagère
- (12) Colle
- (13) Clé hexagonale
- (14) Vêtements Joe
- (15) Sangle
- (16) Pince
- (17) Ancrage mural

Page 9

- 1.1 Fixez (1) à (L) comme illustré.
- 1.2 Fixez (8) à (A), (C) et (L) comme illustré.

Page 10

- 2.1 Fixez (1) à (D), (E), (G) et (H) comme illustré.
- 2.2 Fixez (8) à (D), (E), (G) et (H) comme illustré.

Page 11

- 3.1 Fixez (1) à (B), (F), (I) et (J) comme illustré.

Page 12

- 4.1 Fixez (1) à (M) et (N) comme illustré.
- 4.2 Fixez (8) à (M) et (N) comme illustré.
- 4.3 Fixez (14) à (M) et (N) avec (3) comme illustré.

Page 13

- 5.1 Fixez (F) à (A) avec (2) comme illustré.
- 5.2 Fixez (G), (H) à (N) avec (9) comme illustré.
- 5.3 Utilisez (10) pour couvrir les trous de verrouillage à came comme illustré.

Page 14

6.1 Fixez (I), (J) à (G), (H) et (M) avec (9) comme illustré.

6.2 Utilisez (10) pour couvrir les trous de verrouillage à came comme illustré.

Page 15

7.1 Fixez (A), (C) à l'échantillon de l'étape précédente avec (9) comme illustré.

7.2 Utilisez (10) pour couvrir les trous de verrouillage à came comme illustré.

Page 16

8.1 Fixez (D), (E) à (B) avec (9) comme illustré.

Page 17

9.1 Fixez (L) à (B), (D) et (E) avec (9) comme illustré.

9.2 Utilisez (10) pour couvrir les trous de verrouillage à came comme illustré.

Page 18

10.1 Fixez (D), (E) et (L) à (C) avec (9) comme illustré.

10.2 Utilisez (10) pour couvrir les trous de verrouillage à came comme illustré.

Page 19

11.1 Fixez (Q) à (E) et (H) avec (6) comme illustré.

11.2 Fixez (Q) à (L) et (M) avec (7) comme illustré.

Page 20

12.1 Fixez (P) à (D) et (G) avec (6) comme illustré.

12.2 Fixez (P) à (L) et (M) avec (7) comme illustré.

Page 21

VEUILLEZ NOTER QUE CET APPAREIL DOIT ÊTRE PLACÉ CONTRE UN MUR.

Percez un trou de 5 mm de diamètre (3/16") dans le panneau mural. Enfoncez l'ancrage mural (17) dans le trou jusqu'à ce qu'il affleure. À l'aide de la vis (4)

pour fixer le support mural (16) au panneau mural. à l'aide de vis pour fixer le panneau mural. Utilisez la vis (5) pour fixer le support mural (16) à l'arrière de l'étagère supérieure. Déplacez le meuble à sa position finale. Faites passer la sangle (15) à travers le support (16) comme indiqué sur l'illustration, serrez la sangle (15) jusqu'à ce qu'elle soit bien ajustée. Ne pas trop serrer.

Page 22

14.1 Insérez (11) dans (D) et (E) comme illustré.

14.2 Insérer et mettre (K) sur (11) tel qu'illustré.

14.3 Insérez et placez (O) sur (14) tel qu'illustré.

Page 23**CHARGES MAXIMALES**

Ce meuble a été conçu pour supporter les charges maximales indiquées. En excédant ces limites de charge, le meuble pourrait devenir instable, s'effondrer, et/ou causer des blessures graves.

AVERTISSEMENT : Risque de blessure corporelle - ne pas placer une télévision sur ce meuble. Ce meuble n'est pas approuvé pour une utilisation avec une télévision.

Page 24

Enregistrez votre produit pour recevoir les éléments suivantes:

- * Détails sur les nouvelles tendances - un aperçu sur les nouveautés
- * Sondages - avoir une voix au sein de notre communauté
- * Offres exclusives et codes promo
- * Service de pièces de rechange rapide et facile

Pour enregistrer votre produit, visitez ameriwoodhome.com

5 Étoiles

Visitez le site Web de votre détaillant local, évaluez le produit que vous avez acheté et laissez-nous vos commentaires !

Nous tenons à offrir un grand "Merci" à tous nos clients pour avoir pris le temps d'assembler ce produit "Ameriwood Home", et de nous donner vos commentaires précieux.

Merci