

4524801COM Desk

**NOV
OGR
ATZ**

Date of Purchase ___ / ___ / ___

Lot Number:

B344524801COM00KX

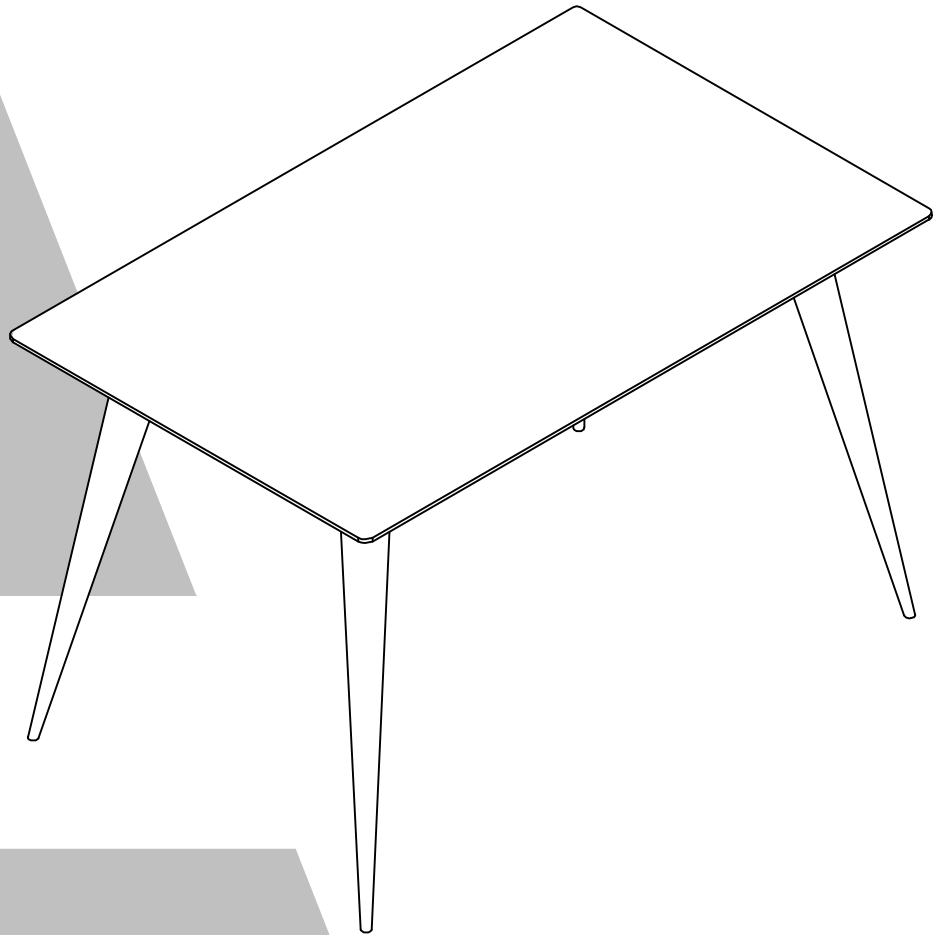

THIS INSTRUCTION BOOKLET CONTAINS **IMPORTANT** SAFETY INFORMATION. PLEASE READ AND KEEP FOR FUTURE REFERENCE.

Do Not Return This Product!

Contact our customer service team for help first.

Call: 1-800-489-3351 (toll free)

Monday-Friday 9am - 5pm CST

Visit: www.ameriwoodhome.com

WARNING

- Unit can tip over causing severe injury or death.
- Anchor unit to stud in wall (if instructed to).
- Do Not allow children to climb on unit.
- Put heavy items on lower shelves or drawers.

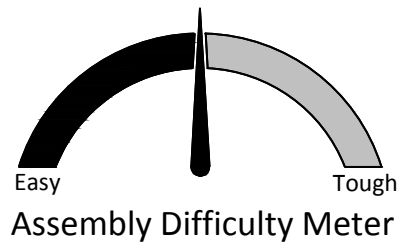

Follow Ameriwood Home



Contact Us!

Do NOT return this product!

Contact our friendly customer service team first for help.

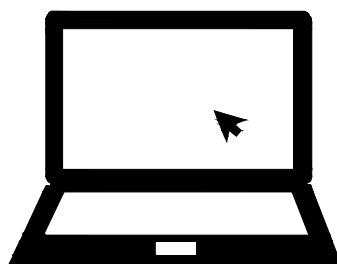
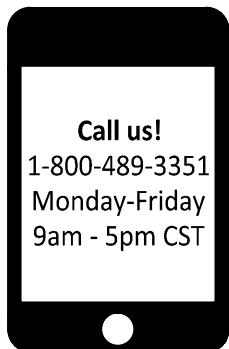

Visit ameriwoodhome.com

Assembly Tips



Helpful Hints

PEOPLE NEEDED FOR ASSEMBLY: **1-2**
ESTIMATED ASSEMBLY TIME: **1 HOUR**

- Open your item in the area you plan to keep it to avoid excessive heavy lifting.
- Identify, sort and count the parts before attempting assembly.
- Compression dowels are lightly tapped in with a hammer.
- Slides are labeled with a **R** (right) and **L** (left) for proper placement.
- Make sure to always face the point on the top of the Cam Lock towards the outer edge.
- Use all the nails provided for the back panel and spread them out equally.
- Back panel must be used to make sure your unit is sturdy.
- Do NOT use harsh chemicals or abrasive cleaners on this item.
- Never push, pull, or drag your furniture.

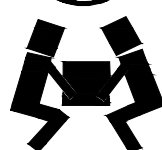

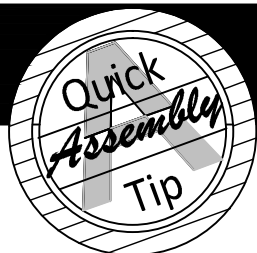

Before You Start

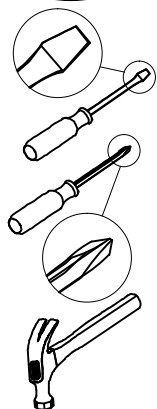

- ✓ Read through each step carefully and follow the proper order
- ✓ Separate and count all your parts and hardware
- ✓ Give yourself enough room for the assembly process
- ✓ Have the following tools: Flat Head Screwdriver, #2 Phillips Head Screwdriver and Hammer
- ✓ Caution: If using a power drill or power screwdriver for screwing, please be aware to slow down and stop when screw is tight. Failure to do so may result in stripping the screw.

Board Identification

Not actual size

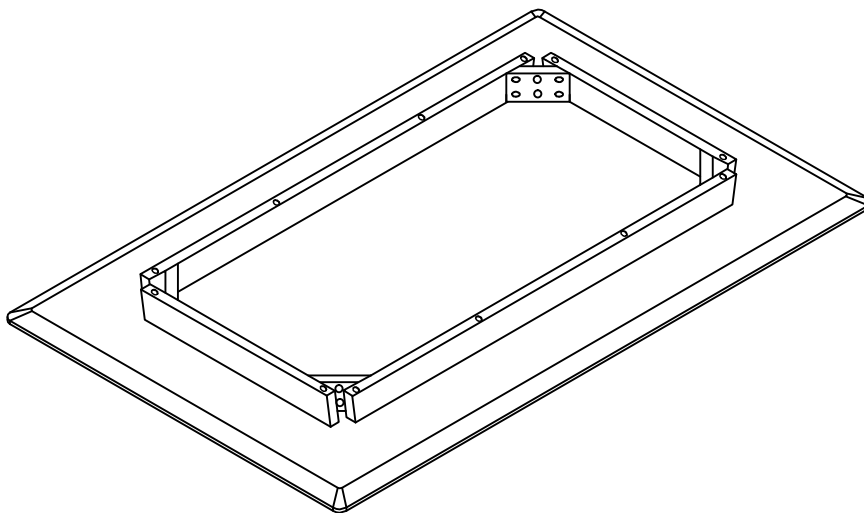

A

Desk Sub-assembly
T4524801010KX

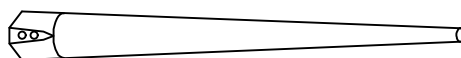

B

LEG
T4524801020KX
QTY:4PCS

Board Identification

Not actual size

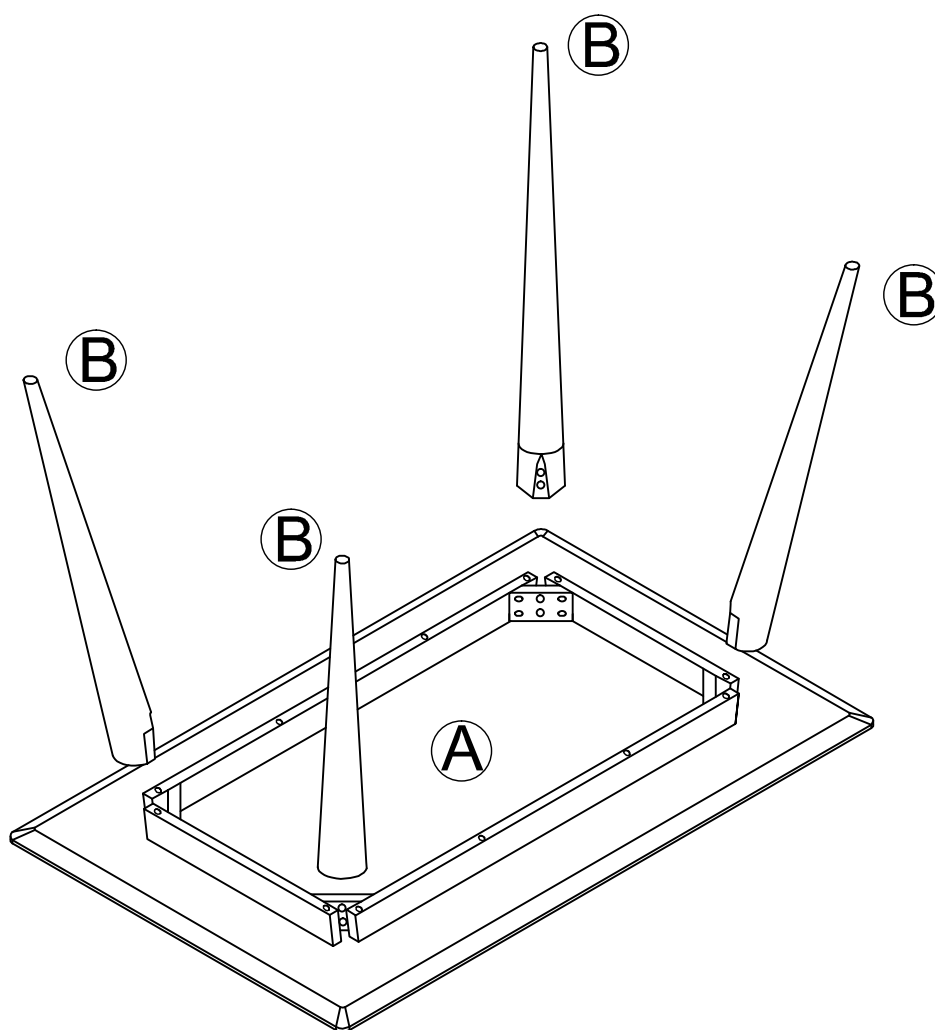

Part List

Actual Size

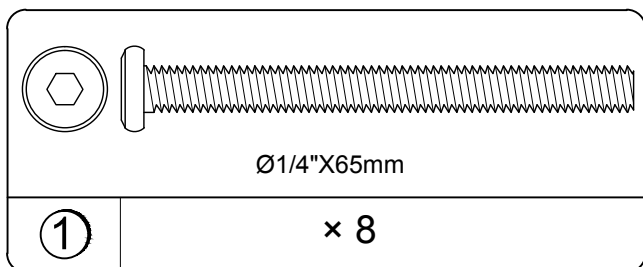

BOLT
TKX1001

Not Actual Size

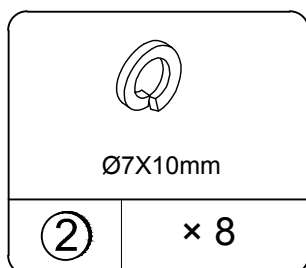

SPRING WASHER
TKX1002

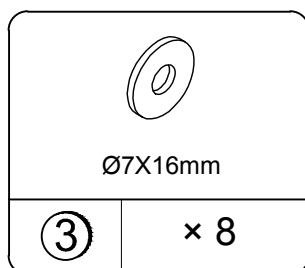



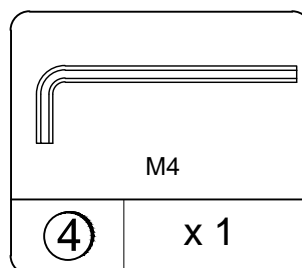

WASHER
TKX1003

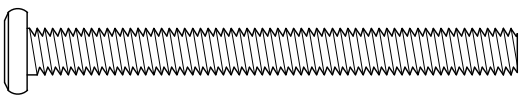

HEX KEY
TKX1004

STEP 1

				
Ø1/4"X65mm		Ø7X10mm		Ø7X16mm
①	× 8	②	× 8	③ × 8
				④ × 1

1.1 Connect (A) & (B) together by (1) , (2) , (3) & (4) as illustrated.

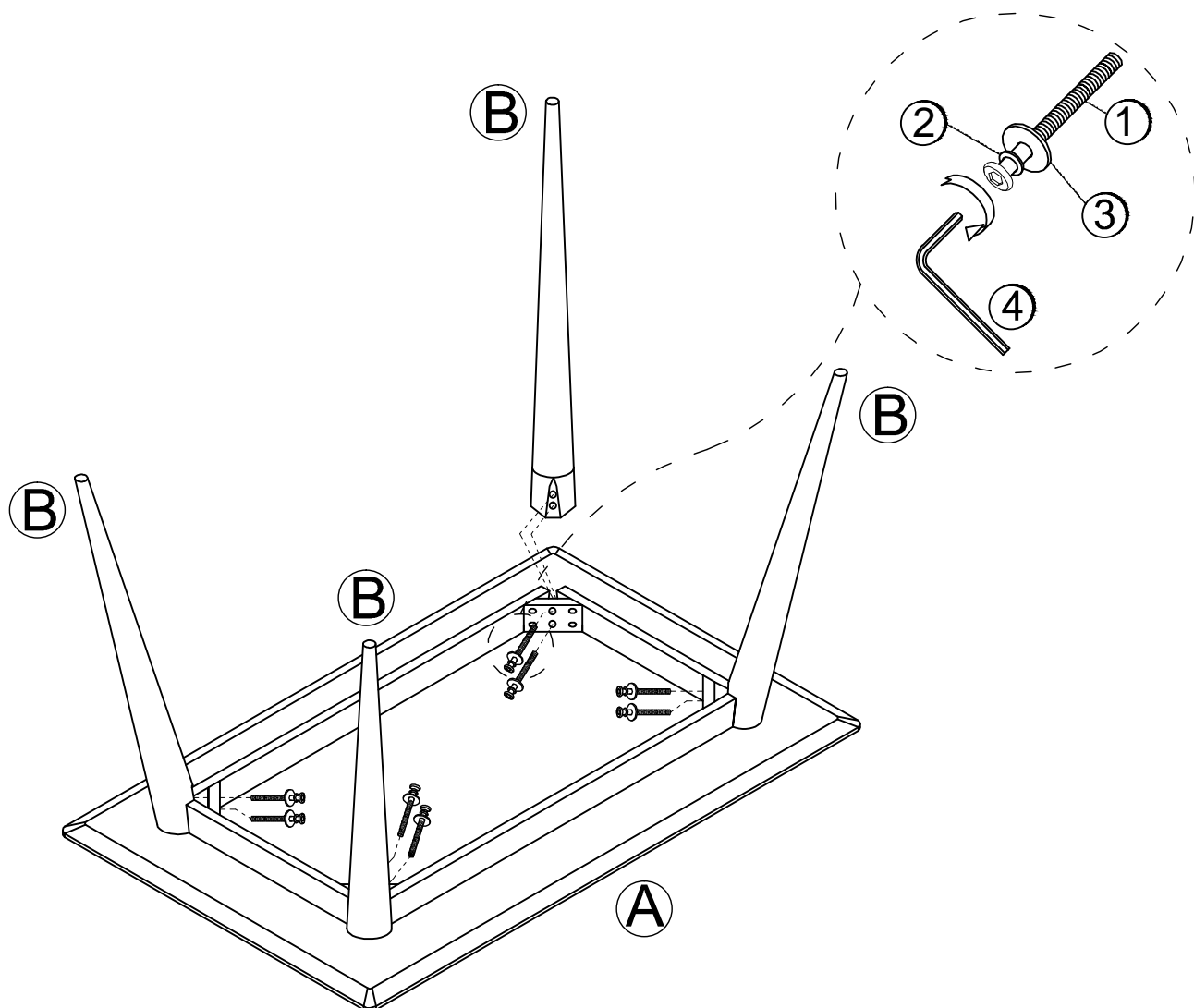

Maximum Loads

This unit has been designed to support the maximum loads shown. Exceeding these load limits could cause sagging, instability, product collapse, and/or serious injury.

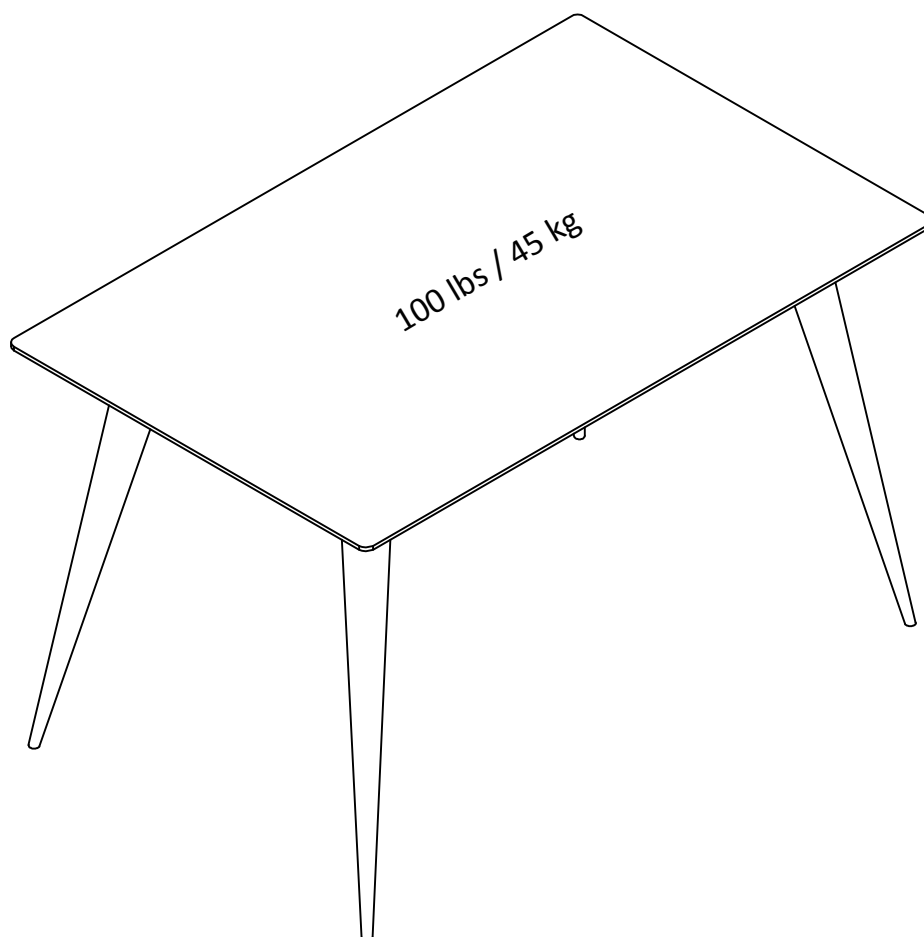

Warning: Risk of injury to persons - do not place a television on this furniture. This furniture is not approved for use with a television.

Certificate of Conformity

1. This certificate applies to the Dorel Home Furnishings, Inc. product identified by this instruction manual.
2. This certificate applies to compliance of this product with the CPSC Ban on Lead-Containing Paint (16 CFR 1303).
3. This product is distributed by: Dorel Home Furnishings, Inc.
410 East First Street South
Wright City, MO 63390
636-745-3351
4. Site of Manufacture: Dongguan China
5. See front page of instruction manual for date of manufacture.

Register your product to receive the following:



- * New trend details - sneak peek on what's new
- * Surveys - have a voice within our community
- * Exclusive deals and discount codes
- * Quick and easy replacement part service

To register your product, visit ameriwoodhome.com

Star Rating



Visit your local retailer's website, rate your purchased product and leave us some feedback!

We would like to extend a big "Thank You" to all of our customers for taking the time to assemble this Ameriwood Home product, and to give us your valuable feedback.

*Thank
You!*

Español

Cubierta Delantera

Este libro de instrucciones contiene información **IMPORTANTE** de seguridad. Por favor lea y manténgalo para referencia en el futuro.

No Regrese este producto! Comuníquese con nuestro amigoso equipo de servicio al cliente para obtener ayuda.

Llámenos al: 1-800-489-3351 (Gratis) Lunes - Viernes 9am - 5pm CST

Visitar: www.ameriwoodhome.com

PRECAUCION

Este mueble puede volcarse y causar graves heridas y/o muerte.

Anclar el mueble a un poste de madera en la pared (si esto se requiere).

No Permita que los niños monten el mueble.

Mantenga los artículos más pesados en los cajones de abajo.

Consejos Útiles (página 2)

- Abra su artículo en el área donde usted planea utilizarlo para evitar levantar y moverlo menos
- Identificar, ordenar y contar las piezas antes de intentar ensamblar
- Las clavijas de compresión se golpean con un martillo
- Las diapositivas están marcadas con una R (derecha) y L (izquierda) para la colocación correcta
- Asegúrese de que siempre este el punto localizado en la parte superior de bloqueador de leva este volteado hacia borde exterior
- Utilizar todos los clavos para el panel de atrás y distribuirlos por igual
- El panel de atrás debe utilizarse para asegurarse de que la unidad quede fija y firme
- No use químicas fuertes ni limpiadores abrasivos en este artículo
- Nunca empuje, tire ni arrastre los muebles

Antes de Que Empieces (página 3)

- Lea cuidadosamente cada paso y siga el orden correcto

- Separar y contar todas sus piezas y hardware

- Dése suficiente espacio para el proceso de ensamble

- Tenga las siguientes herramientas: destornillador de cabeza plana, #2 cabeza Phillips

Destornillador y martillo

- Precaución: Si usa un taladro electrónico o un destornillador eléctrico para atornillar, por favor asegúrese que deje de atornillar cuando el tornillo este apretado. Fallar hacer esto puede causar barrer el tornillo.

Sistema de fijar el bloqueo de leva (página 3)

Esta sistema de fijar el bloqueo de leva sera usado en todo el proceso ensamble.

Identificación de los Paneles (Página 4-5)

Este no es el tamaño real

(A) ESCRITORIO SUPERIOR

(B) ESCRITORIO SUPERIOR

Lista de Piezas (Página 6)

Tamaño real

(1) Perno

Este no es el tamaño real

(2) Lavadora

(3) Lavadora

(4) LLAVE HEXAGONAL

Couverture Avant

CE LIVRET D'INSTRUCTION CONTIENT DES INFORMATIONS **IMPORTANTES** SUR LA SÉCURITÉ. VEUILLEZ LIRE ET GARDER POUR UNE RÉFÉRENCE FUTURE

Ne retournez pas ce produit! Contactez notre équipe de service à la clientèle amicale d'abord pour obtenir de l'aide.

Appelez-nous: 1-800-489-3351 (sans frais) du Lundi au Vendredi de 9h à 17h Heure Centrale

Visitez: www.ameriwoodhome.com

ATTENTION

Le meuble peut basculer et causer des blessures graves ou la mort.

Ancrer le meuble à une planche murale dans le mur (si indiqué).

Ne laissez pas les enfants grimper sur le meuble.

Placez les articles lourds sur les étagères ou dans les tiroirs inférieurs.

Astuces Utiles (page 2)

-Ouvrez votre article dans la zone que vous prévoyez de le garder pour moins de levage lourd

-Identifier, trier et compter les pièces avant d'essayer d'assembler

-Les goujons de compression sont taraudés avec un Marteau

-Les glissières sont marquées d'un R (droit) et d'un L (gauche) pour un bon placement

-Assurez-vous toujours de faire face la pointe situé sur le haut de la Serrure de Came vers le bord extérieur

-Utiliser tous les clous fournis pour le panneau arrière et les répartir également

-Le panneau arrière doit être utilisé pour vous assurer que votre appareil est robuste

-N'utilisez pas de produits chimiques agressifs ou de nettoyeurs abrasifs sur cet appareil

-Ne jamais pousser, tirer, ou faire glisser votre meuble

Avant de Commencer (page 3)

-Lisez attentivement chaque étape et suivez le bon ordre

-Séparez et comptez toutes vos pièces et matériaux

-Donnez-vous suffisamment de place pour l'assemblage

-Avoir les outils suivants: tournevis à tête plate, #2 tournevis Phillips, et Marteau

-Attention: Si vous utilisez une perceuse électrique ou un tournevis électrique pour visser, veillez à ralentir et arrêter lorsque la vis est bien serrée. Le non-respect de cette consigne peut endommager la vis.

Système de Fixation de Came (page 3)

Ce Système de Fixation de Came sera utilisé tout au long de l'assemblage

Français

Identification des matériaux (Page 4-5)

Pas de taille réelle

(A) HAUT DE BUREAU

(B) jambe

Liste des pièces (Page 6)

Taille réelle

(1) verrou

Pas de taille réelle

(2) lave-vaisselle

(3) lave-vaisselle

(4) CLÉ HEXAGONALE